

The Atlas Copco logo is displayed in white, italicized serif font within a blue rectangular box. The box has two white horizontal bars above and below the text.A blue triangular graphic overlay in the bottom-left corner contains a white technical drawing of a mechanical part with various dimensions and annotations. The drawing is partially obscured by the text.

Fabrication and Maintenance PRO range

BRING A CENTURY OF EXPERIENCE
TO YOUR PROJECT.



Twitter – Atlas Copco Industrial Tools & Solutions
LinkedIn – Atlas Copco Industrial Tools & Solutions
Youtube – Atlas Copco Industrial Tools & Solutions

Contents

IMPACT WRENCHES	4
RATCHET WRENCHES	12
SCREWDRIVERS	16
DRILLS	24
ANGLE GRINDERS	28
DIE GRINDERS	32
SANDING & POLISHING	38
PERCUSSIVE TOOLS	46
AIR PREPARATION UNITS	54
INLINE TEST EQUIPMENT	63
CONNECTORS AND COUPLINGS	64
HOSES	88
HOSE REELS	97
BLOW GUNS & TEST EQUIPEMENT	102
VIBRATION AND SOUND VALUES	104

How to use our tools safely

Safety tips

Below are few tips to increase power tool safety and help avoid injury and accidents. These tips, however, are no substitute for the PRO tools safety and instruction manuals.



Conduct a visual inspection of the tool before use

Check the tool, including hoses or fittings, for signs of damage and replace defect parts if necessary. Check for cracks in the sockets, grinding wheels, chisels, etc., and replace damaged parts if required.



Check the free speed of the tool

Make sure the measured speed at a pressure of 6.3 bar does not exceed the rated speed of the tool. Before checking the measured speed, always remove wheels, burrs, sockets, etc.



Use the right accessories

Always use the accessories recommended in the safety manual. Never use hand sockets with impact or ratchet wrenches. Never use a grinding wheel, burr, cone wheel, etc., marked with a speed lower than the speed of the grinder. Always disconnect the air tool before changing accessories.



Wear safety gear

Always use appropriate safety equipment, such as goggles and earplugs. When required, wear gloves, apron and helmet. When working with materials that produce airborne particles, be sure to wear a dust mask or similar protective gear and use other equipment, such as dust extractors, to control exposure to harmful substances.



Before grinding, test the tool

Test run the grinder in a protected area before starting work and after changing the wheel. Make sure that the space around is free from other people.



Maintain a safe work area

Keep other people at a safe distance away from your workspace while you use the tools. Beware of hoses on the walking or work surface. Always direct exhaust air away from yourself and others. Never use an air tool in explosive atmospheres. Stay away from electric wiring because an air tool is not insulated for contact with electrical power sources.



After work

Always disconnect your air tool after use.

Our tools come with a manual

Safe hand tool operation is a fundamental tenet of PRO tool design. All of our tools have features that safeguard operators against work-related injuries and machine-related hazards. But the best way to ensure hand tool safety is to ensure that operators use the recommended safety practices.

That is why each PRO tool comes with a safety and instruction manual that operators should read and follow when using our tools. For a copy of these manuals, contact your Atlas Copco representative or visit www.atlascopco.com.

For more information on safe power tool operation, please refer to the rules for tool safety from these two organizations:

Safety Code for Portable Air Tools, ANSI B186.1
American National Standards Institute (ANSI)
11 W. 42nd St, 13th floor, New York, NY 10036.

Further occupational health & safety information, see web sites:

<http://www.osha.gov> (USA)
<http://europe.osha.eu.int> (Europe)



Atlas Copco tools for industrial use

Some years ago, we took the high quality die-cast molds used to manufacture industrial tools for production lines and produced the PRO range of hand-held tools for light industry users.

The tools were an immediate success and we continuously expanded the range with tools that demanding industrial users need to get the job done.

Features and benefits

- Design** Being Industry leaders in Ergonomics, each Atlas Copco tool is designed with "you" the user in mind.
- Robust** Sturdy material, solid design, excellent performer. Atlas Copco tools keeps on working and gets results.
- Quality** Built to last.
- Power** The work gets done in record time. It's easy to handle tough jobs with PRO.
- Warranty** The assurance of quality and performance is a generous warranty.

Find more information regarding spare parts, service, dimensional drawings, sustainable productivity and general recommendations:

www.atlascopco.com

Impact Wrenches



Low weight – High output

- Models with twin hammer impact mechanism for fast run down
- Models with composite housing for best power-to-weight ratio and with durable aluminum and magnesium housing
- Button controlled forward/reverse settings
- Easy one hand operation for pistol grip models
- Ergonomic handles with rubber grip

Impact Wrenches



W2915

W29-series

With easy operation the W29-series are your perfect partner for general assembly and tackling the toughest industrial jobs that requires high torque output.

These models features a twin hammer impact mechanism for fast run down with a composite housing for best power-to-weight ratio with four torque settings.

Easy one hand operation (Left or right handed) with button controlled torque setting (forward/reverse) with a ergonomic handle with anti-slip rubber grip.



W2910



W2911



W2920

Model	Bolt size mm	Square drive size in	Torque - Forward Nm	Torque - Reverse Nm	Torque Range Nm	Free speed r/min	Weight kg	Air consumption l/s	Rec. hose size mm	Air inlet thread BSP	Model type	Impact mechanism	Ordering No.
W2910	M14	3/8"	310	500	150-400	6500	1.2	17	10	1/4"	Pistol	Twin hammer	8434124850
W2911	M14	1/2"	370	500	150-400	7300	1.2	17	10	1/4"	Pistol	Twin hammer	8434124851
W2915	M16	1/2"	710	1000	200-800	7700	2.0	18	10	1/4"	Pistol	Twin hammer	8434124852
W2920	M30	3/4"	1400	1500	300-1450	5500	3.2	27	13	3/8"	Pistol	Twin hammer	8434124853

Torque range (min/max) is a calculated value acc. To Skidmore. Performance is depending on air installation and type of bolted joint.



WS1001



WS1002



WS1003

Model	Square drive size in	Socket type	Number of sockets	Sockets included	Ordering No.
PRO WS1001	3/8"	Metric impact socket	13	7, 8, 9, 10, 11, 12, 13, 14, 15, 16, 17, 18, 19 mm	4112 0607 91
PRO WS1002	1/2"	Metric impact socket	14	10, 11, 12, 13, 14, 15, 16, 17, 18, 19, 21, 22, 26, 27 mm	4112 0607 92
PRO WS1003	1/2"	Metric deep impact socket	14	10, 11, 12, 13, 14, 15, 16, 17, 18, 19, 21, 22, 26, 27 mm	4112 0607 93

A PUZZLE WE'VE SPENT OVER 145 YEARS ON



Screws and nuts drive you... Nuts. To master this fully we have put over 145 years into developing our tools. All the expertise, know-how and innovations we have picked up along the way go into every tool we build, and can then be added to your project. Read more at atlascopco.com

BRING A CENTURY OF EXPERIENCE TO YOUR PROJECT



PRO W2915
Impact Wrench

Atlas Copco

Impact Wrenches

W24-series

These tools features a steel, aluminum and magnesium housing and can handle tough environments providing fast rundown and tightening.

They have powerful impact mechanisms for fast run down with four torque settings.

The W24-series features compact pistol to larger straight models for many different applications.



W2415



W2410



W2411



W2412



W2427



W2420



W2425



W2428

Model	Bolt size mm	Square drive size in	Torque - Forward Nm	Torque - Reverse Nm	Torque Range Nm	Free speed r/min	Weight kg	Air consumption l/s	Rec. hose size mm	Air inlet thread BSP	Model type	Impact mechanism	Ordering No.
W2410	M10	1/4" HEX	98	110	13 - 80	7000	1	11	10	1/4"	Pistol	Twin hammer	8434124854
W2411	M10	3/8"	130	140	13 - 110	7000	1	11	10	1/4"	Pistol	Twin hammer	8434124855
W2412	M16	1/2"	250	350	100 - 300	7400	1.4	13	10	1/4"	Pistol	Twin hammer	8434124862
W2415	M16	1/2"	550	750	150 - 650	7700	2.7	20	10	1/4"	Pistol	Pin clutch	8434124856
W2420	M30	3/4"	1450	1700	650 - 1300	5600	5.4	26	13	3/8"	Pistol	Twin hammer	8434124857
W2425	M33	1"	2200	2550	700 - 1400	4500	10.2	44	19	1/2"	Pistol	Pinless	8434124858
W2427	M33	1"	1800	2200	700 - 1500	4500	6.7	36	19	1/2"	Straight	Twin hammer	8434124859
W2428	M33	1"	2200	2800	800 - 1600	5000	10.5	48	19	1/2"	Straight	Pinless	8434124860

W2415 KIT: Incl. 5 sockets. Sizes: 13, 15, 17, 19 & 24 mm.

8434124861

Torque range (min/max) is a calculated value acc. To Skidmore. Performance is depending on air installation and type of bolted joint.

**WE'VE SPENT OVER 145
YEARS SOLVING PROBLEMS
OF DIFFERENT SIZES**

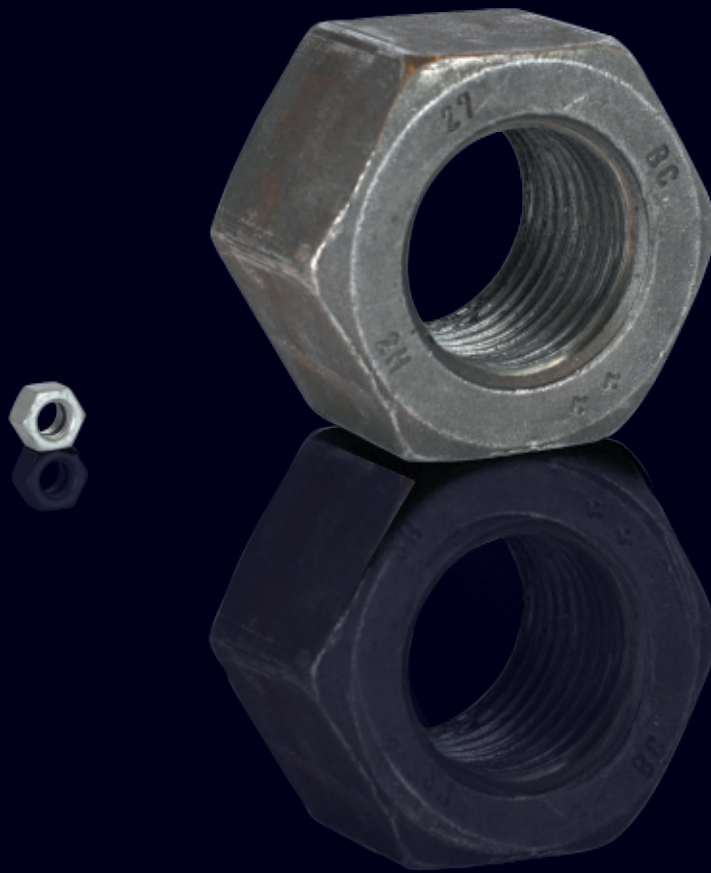

Screws and nuts drive you... Nuts. To master this fully we have put over 145 years into developing our tools. All the expertise, know-how and innovations we have picked up along the way go into every tool we build, and can then be added to your project. Read more at atlascopco.com

BRING A CENTURY OF EXPERIENCE TO YOUR PROJECT



PRO W2915
Impact Wrench

Atlas Copco

Impact Wrenches

Tightening tools

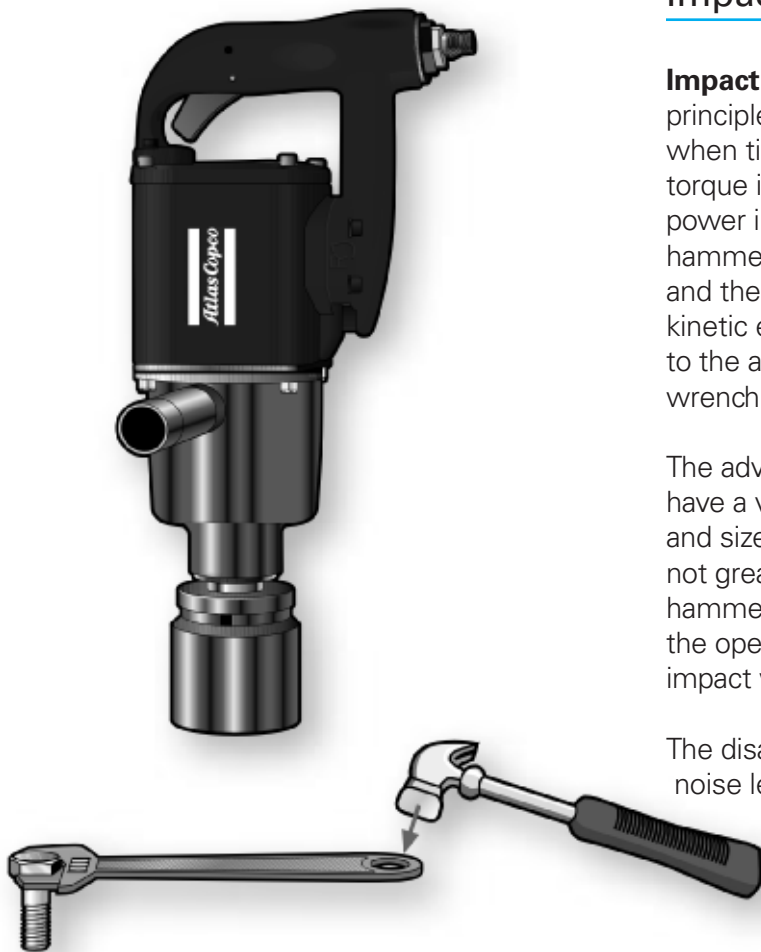

Principle of impact tools.

Impact tools

Impact wrenches are based on the same principle as using a hammer to strike a wrench when tightening a bolt or screw, building up torque impact by impact. In the case of the power impact wrench run by an air motor, the hammer is the combined mass of the rotor and the impact mechanism which delivers their kinetic energy, once or twice per revolution, to the anvil and socket, which represent the wrench in the comparison.

The advantage of impact wrenches is that they have a very high capacity relative to the weight and size of the tool. As the reaction torque is not greater than that needed to accelerate the hammer the reaction force transferred back to the operator is very small, which makes the impact wrench very flexible and simple to use.

The disadvantages are the comparatively high noise level of the impact wrench and the difficulty in measuring the applied torque and consequently also the limited possibility to achieve accurate torque control.

Consequently, the impact wrench is the ideal tool for loosening rusty and stuck bolts in maintenance work in chemical plants, refineries and other heavy industries. Impact wrenches are also suitable for a variety of applications that do not require the highest degree of accuracy.



W2411
Impact Wrench

Smart Qic
& Multiflex

W2428
Impact Wrench

W2415
Impact Wrench

Smart
Qic Coupling

W2915
Impact Wrench

Multiflex
& EgroQic

BRING A CENTURY OF EXPERIENCE TO YOUR PROJECT

Ratchet Wrenches



Compact and powerful!

- Great power-to-weight ratio
- Robust composite housing
- Rubber grip on handle for insulation and comfort
- Easy switch between forward and reverse
- 360 degree adjustable air exhaust

Ratchet Wrenches

W26-series

PRO ratchet wrenches are powerful, reversible and designed for easy access in confined spaces.

The tools are light, comfortable and easy to work with, due to their robust composite housing and high power-to-weight ratios.



W2620 / W2621

Model	Bolt size mm	Square drive size in	Torque range Nm	Free speed r/min	Weight kg	Length mm	Air con- sumption l/s	Rec. hose size mm	Air inlet thread BSP	Ordering No.
W2611	M8	1/4"	4-40	280	0.55	192	9	10	1/4"	8431 0350 11
W2610	M8	3/8"	4-40	280	0.55	192	9	10	1/4"	8431 0350 10
W2621	M12	3/8"	5-68	170	1.1	271	10	10	1/4"	8431 0350 21
W2620	M12	1/2"	5-68	170	1.1	271	10	10	1/4"	8431 0350 20
W2631	M14	3/8"	25-80	200	1.2	307	11	10	1/4"	8431 0350 31
W2630	M14	1/2"	25-80	200	1.2	307	11	10	1/4"	8431 0350 30

Torque range (min/max) is a calculated value acc. To Skidmore. Performance is depending on air installation and type of bolted joint.

Ratchet Wrenches



W2610 /W2611



W2630 /W2631



WS1001



WS1002



WS1003

Model	Square drive size in	Socket type	Number of sockets	Sockets included	Ordering No.
PRO WS1001	3/8"	Metric impact socket	13	7, 8, 9, 10, 11, 12, 13, 14, 15, 16, 17, 18, 19 mm	4112 0607 91
PRO WS1002	1/2"	Metric impact socket	14	10, 11, 12, 13, 14, 15, 16, 17, 18, 19, 21, 22, 26, 27 mm	4112 0607 92
PRO WS1003	1/2"	Metric deep impact socket	14	10, 11, 12, 13, 14, 15, 16, 17, 18, 19, 21, 22, 26, 27 mm	4112 0607 93



W2428
Impact Wrench

P2531
Chipping Hammer

SmartOic
Coupling

W2415
Impact Wrench

HOME OF INDUSTRIAL IDEAS - SERVING THE INDUSTRY SINCE 1873

● W2915
Impact Wrench

● MultiFlex & Atlas Copco
ErgoQic Coupling

● G2588
Angle Grinder

BRING A CENTURY OF EXPERIENCE TO YOUR PROJECT

Screwdrivers



Speed and precision!

- Different variants like shut-off and slip-clutch for precision clamping. Impact drive and direct drive for a wide variety of applications
- Well balanced and ergonomic
- Soft-start trigger for smooth operation
- 360 degree adjustable air exhaust
- Silent



Selection guide

	Machine screw 4.8	Machine screw 8.8	Thread forming screw-M	Thread forming screw-ST	Thread forming screw-ST plastic	Self drilling screw-S	Wood screw
Impact clutch	◇	◇	◇			◇	◇
Direct drive	◇	◇	◇	◇		◇	◇
Slip clutch	◇	◇	◇	◇	◇	◇	◇
Shut-off clutch	◇	◇	◇	◇		◇	

◇ Recommended

◇ Usable

Pneumatic screwdrivers

Direct Drive Screwdrivers

Direct Drive Screwdrivers are suitable for self-drilling and wood screws. The tools are well balanced and quiet. A soft-start trigger ensures smooth operation and the air exhaust is adjustable through 360 degrees.

Impact Drive Screwdrivers are lightweight tools offering a productive blend of operator comfort and exceptional performance. There are two models – both are reversible with a simple flip-off lever on the side of the tool handle.



S2305



S2480

Model	Bolt size mm	Quick change chuck in	Torque range Nm	Free speed r/min	Weight kg	Length mm	Air cons. l/s	Rec. hose size mm	Air inlet thread BSP	Ordering No.
Impact drive										
S2480	M5	1/4"	6-13	6500	0.8	132	10	10	1/4"	8431 0257 90
Direct drive										
S2305	M8	1/4"	0-12	750	0.9	198	5.6	8	1/4"	8431 0257 28
S2326	M6	1/4"	0-4.5	2400	0.8	178	5.6	8	1/4"	8431 0257 36

Pneumatic screwdrivers

Shut-off Screwdrivers

Shut-off Screwdrivers offer impressively high torque accuracy. Our fast shut-off models deliver smooth performance and high quality tightening.

Slip-Clutch Screwdrivers provide an implied pulsating force, or slip, once you reach the desired torque.

Both versions feature adjustable torque settings, trigger and push start for pistol grips, and lever and push start for straight models.



S2308-C / S2310-C



S2450-P / S2452-P



S2340-C / S2360-C / S2370-C



S2416-L / S2426-L / S2428-L

Model	Screw capacity mm	Quick change chuck in	Torque range Nm	Free speed r/min	Weight kg	Length mm	Air cons. at free speed l/s	Rec. hose size mm	Air inlet thread BSP	Starting method			Ordering No.
										Push	Push and trigger/lever	Trigger/lever	
Slip clutch													
S2308-C	M6	1/4"	2.5-11	950	1.1	225	8.4	10.0	1/4"	-	●	-	8431 0257 20
S2310-C	M5-8	1/4"	2-15	800	1.1	225	8.5	10.0	1/4"	-	●	-	8431 0257 24
S2307-CE	M6	1/4"	2.5-10	900	1.2	245	8.4	10.0	1/4"	-	-	●	8431 0257 26
S2340-C	M3	1/4"	0.5-2	1300	0.9	250	4.0	6.3	1/4"	-	●	-	8431 0257 40
S2360-C	M4-5	1/4"	1.3-7	700	0.9	260	4.0	6.3	1/4"	-	●	-	8431 0257 60
S2370-C	M5	1/4"	2-6	1300	0.9	250	4.0	6.3	1/4"	-	●	-	8431 0257 70
Shut off													
S2426-L	M4	1/4"	1.2-2.6	1500	0.9	230	6.0	8.0	1/4"	-	●	-	8431 0257 80
S2428-L	M4-5	1/4"	3.5-7	700	1.0	242	6.0	8.0	1/4"	●	-	-	8431 0257 81
S2416-L	M3	1/4"	0.5-1.6	1500	0.9	230	6.0	8.0	1/4"	-	-	●	8431 0257 82
S2450-P	M5	1/4"	2.4-5	1100	1.1	225	6.0	8.0	1/4"	-	-	●	8431 0257 84

S2307-CE external adjustable clutch. The slip clutch tool needs the lever to be pressed. Then push down in order for the bit to tighten.

Electric screwdrivers

Handheld

The S8 series offers a wide variety of screwdrivers that give great speed and high precision.

Built with an ergonomic design, the low torque screwdriver S8 offers a plug & play solution for your assembly needs. The S8 series is designed to deliver great quality and increase efficiency.

- **Industrial design:** Ergonomic design for easy operator handling
- **High durability:** Build to last
- **Brushless motor:** Providing long service intervals
- **Plug & play:** Simple start-up process
- Controllers and tools are ordered separately.



Model	Bit drive	Torque range min - max [ft lb]	Torque range min - max [cNm]	Free speed r/min	Weight kg	Weight lbs	Ordering No.
S8020	1/4" Hex	0.26-1.7	3-20	700-1000	0.46	1.01	4221 0002 73
S8020-WS	Wing shank 4 mm	0.26-1.7	3-20	700-1000	0.46	1.01	4221 0002 72
S8050	1/4" Hex	0.43-4.3	5-50	700-1000	0.46	1.01	4221 0002 74
S8120	1/4" Hex	1.3-10.4	15-120	700-1000	0.46	1.01	4221 0002 75
S8120-2000	1/4" Hex	1.3-10.4	15-120	1400-2000	0.46	1.01	4221 0002 76
S8160	1/4" Hex	1.7-13.9	20-160	700-1000	0.46	1.01	4221 0002 77
S8200	1/4" Hex	3.5-17.4	40-200	700-1000	0.46	1.01	4221 0002 78
S8250	1/4" Hex	4.3-21.7	50-250	500-750	0.46	1.01	4221 0002 79
Power supply							
EBS D					0.38	0.84	4221 0002 80

NOTE. Power Supply needs to be ordered separately

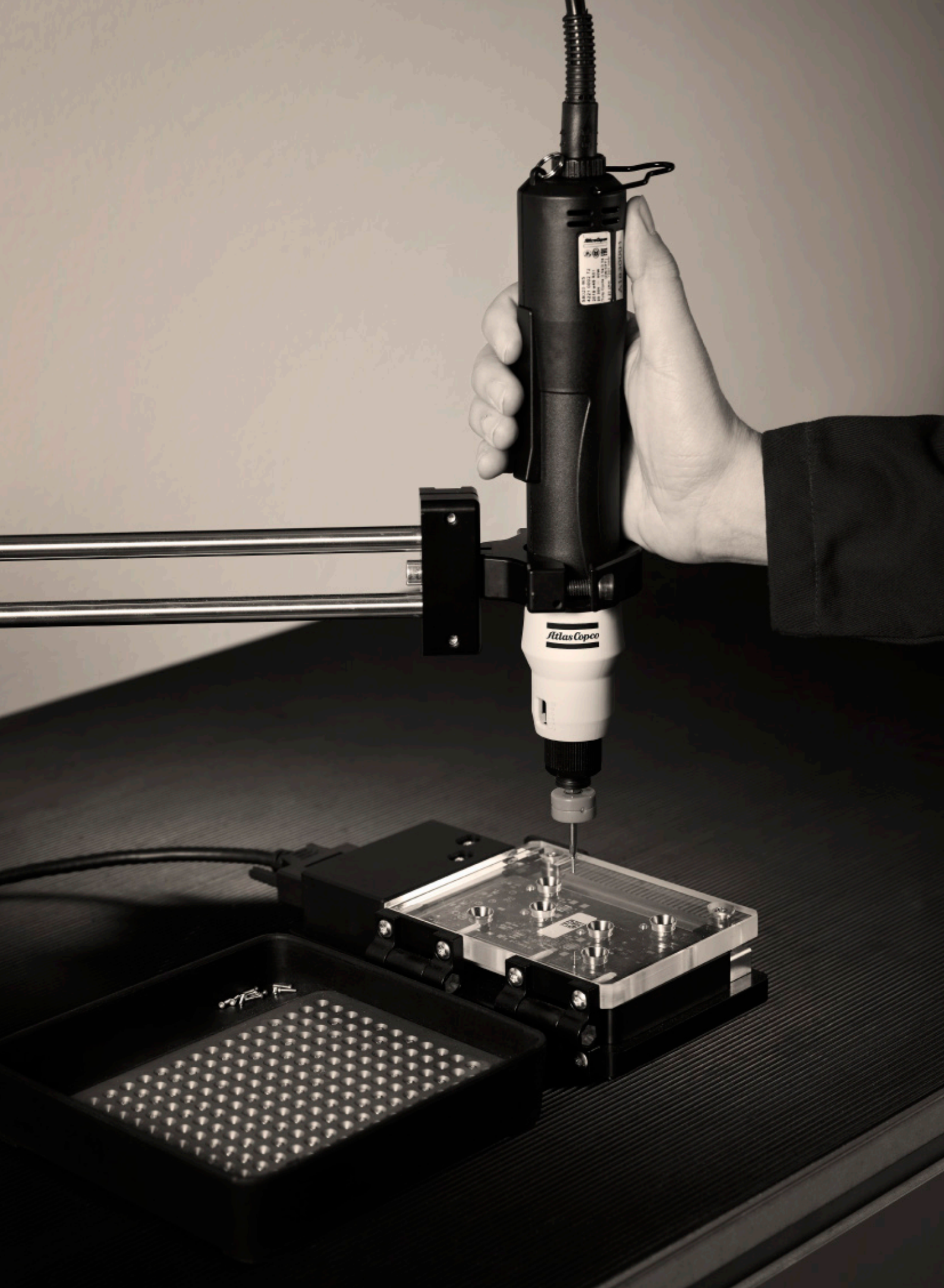

Drills



Superior hole quality!

- Well balanced and ergonomic
- High spindle accuracy
- Soft-start throttle
- Silent
- Air exhaust through handle
- Oil-free
- Available with key or quick chuck



Selection guide

Model	r/min	Drill dim. / mm	Mild steel 20–30 m/min	Alloy steel 5–15 m/min	Cast iron 15–20 m/min	Aluminum & bronze 50–80 m/min	Wood and board 80–150 m/min	Composite 50–100 m/min
D2112	5,400		1.0–2.0	-	-	2.5–5.0	4.0–8.0 ^a	1.0–5.0
D2116/D2160	2,400		2.5–6.0	1.0–3.0	2.0–4.0	8.0–13.0 ^a	8.0–13.0 ^a	-
D2163	2,000		2.5–6.0	1.0–3.0	2.0–4.0	8.0–13.0 ^a	8.0–13.0 ^a	-
D2121	750		8.0–13.0	3.0–8.0	7.0–13.0	-	-	-
D2148-R	750		8.0–13.0	3.0–8.0	7.0–13.0	-	-	-

a) Drill size larger than standard chuck capacity.

Drills



D2121/D2121Q

D21-Series

PRO drills are all-metal and designed with operator comfort in mind. They come in three different versions, pistol grip, straight grip and angle grip.

They are available with key chuck or quick change chuck.



D2112/D2116



D2163



D2112Q/D2116Q



D2160Q

Model	Max free speed r/min	Max output kw	Chuck capacity mm	Weight kg	Air cons. at max output l/s	Rec. hose size mm	Air inlet thread BSP	Drill type handle				Chuck type		Ordering No.
								Pistol	Straight	Angle	Reversible	Key	Quick	
D2112	5400	350	0-6.5	1	10	10	1/4"	●	-	-	-	●	-	8421 0405 05
D2112Q	5400	350	1.5-10	1	10	10	1/4"	●	-	-	-	-	●	8421 0405 10
D2116	2400	350	1.5-10	1	10	10	1/4"	●	-	-	-	●	-	8421 0405 13
D2116Q	2400	350	1.5-10	1	10	10	1/4"	●	-	-	-	-	●	8421 0405 15
D2116-R	2400	350	1.5-10	1	10	10	1/4"	●	-	-	●	●	-	8421 0405 16
D2116-RQ	2400	350	1.5-10	1	10	10	1/4"	●	-	-	●	-	●	8421 0405 17
D2121	750	350	2-13	1.4	10	10	1/4"	●	-	-	-	●	-	8421 0405 21
D2121Q	750	350	1.5-13	1.4	10	10	1/4"	●	-	-	-	-	●	8421 0405 25
D2148-R	750	250	2-13	1.5	10	10	1/4"	●	-	-	●	●	-	8421 0407 03
D2148-RQ	750	250	1.5-13	1.5	10	10	1/4"	●	-	-	●	-	●	8421 0407 05
D2160	2400	460	1.5-10	0.9	11	10	1/4"	-	●	-	-	●	-	8421 0410 16
D2160-Q	2400	460	1.5-10	0.9	11	10	1/4"	-	●	-	-	-	●	8421 0410 20
D2163	2000	330	1.5-10	1.1	9	10	1/4"	-	-	●	-	●	-	8421 0410 08
D2163-Q	2000	330	1.5-10	1.1	9	10	1/4"	-	-	●	-	-	●	8421 0410 15

Accessories

	Ordering No.
1-6.5 mm chuck capacity (standard with D2112)	4021 0444 00
1.5-10 mm chuck capacity (standard with D2116, D2163)	4021 0446 00
2-13 mm chuck capacity (standard with D2121, D2148-R)	4021 0447 00
1-10 mm keyless chuck (standard with D2112Q, D2116Q)	4021 0497 00
1.5-13 mm keyless chuck (standard with D2121Q, D2148-RQ)	4021 0496 00
Quick-change chuck for 1/4" bits mount 3/8"-24 UNF	4021 0443 00
Exhaust air hose (D2112, D2116, D2121)	4210 2053 00
Exhaust air hose (2148-R)	4210 2929 00
Exhaust air hose (D2163, D2163)	4150 1077 80
Support handle (D2163)	4110 1355 85
Support handle (D2160)	4110 1355 81

Productivity Kit

Model	Economical air flow	Hose, 5 m	Coupling	Lubrication	Ordering No.
For drills and nutrunners with 1/4" BSP air inlet					
MIDI Optimizer F/RD EQ10-C13-1/4"	21 l/s	Cablar 13 mm	ErgoQIC 10	Yes	8202 0850 11

Angle Grinders



Increase **your productivity**

- Speed governor for optimal process speed and highest productivity
- Great power-to-weight ratio
- Rubber grip for insulation and comfort
- Safety lever to avoid unintentional starts
- Adjustable wheel guard

Angle Grinders



G2408-125

G24/25-series

PRO grinders are a popular choice for surface preparation in general industry. They are lightweight tools that deliver all the power you need, yet easy to handle.

For additional comfort they are equipped with a rubber handle grip and adjustable wheel guard. All grinders except the **G2408**-series are equipped with a speed governor to ensure the grinding wheel operates at optimum speed.



G2511



G2588

Model	Max free speed r/min	Max output kW	Max wheel dia mm	Spindle thread	Spindle length mm	Weight kg	Height over spindle mm	Air cons. at max output l/s	Air cons. at free speed l/s	Rec. hose size mm	Air inlet thread BSP	Ordering No.
G2408-100	12000	0.35	100	UNF 3/8"	17	0.9	61	9	13	10	1/4"	8423 0314 60
G2408-115	12000	0.35	115	UNF 3/8"	17	0.9	61	9	13	10	1/4"	8423 0314 78
G2408-125	12000	0.35	125	UNF 3/8"	17	0.9	61	9	13	10	1/4"	8423 0314 80
G2511-125	12000	0.9	125	M14	18	1.8	61	20	17	13	3/8"	8423 0317 00
G2511-115	12000	0.9	115	M14	18	1.8	61	20	17	13	3/8"	8423 0317 01
G2511-100	13300	0.9	100	UNF 3/8"	17	1.8	61	20	17	13	3/8"	8423 0317 02
G2588-230-M14	6600	1.7	230	M14	17	2.4	91.5	32	17	16	1/2"	8423 0132 82
G2588-180-M14	8500	1.7	180	M14	14	2.4	91.5	32	17	16	1/2"	8423 0132 88

Accessories

Accessories Grinders	G2408	G2511	G2515	G2588
Flange depressed center wheel (incl. with tool)	-	-	-	4150 1160 02
Flange cut-off wheel (incl. with tool)	-	-	-	-
Flange nut	4150 1160 00	4150 1160 02	4112 3002 11	-
Flange nut, quick change Fixtec - M14	-	4150 1929 00	-	4150 1929 00
Support handle	4110 1355 85	4110 1355 85	4111 3002 97	4110 1355 89
Vibration damped handle	4150 1521 80	4150 1521 80	-	4150 1521 80
Cut-off kit	-	-	4112 1553 90	-
Add on spot suction				
Ø 125 mm	3780 4032 14	3780 4032 14	-	-
Ø 180-230 mm	-	-	3780 4032 12	3780 4032 12
Alu-cut guard kit				
Saw blade, Ø 125 mm for cutting applic, 30 teeth, 2 mm thick	-	4112 1164 00	-	-
Saw blade, Ø 125 mm for milling applic, 6 teeth, 4 mm thick	-	4112 1162 00	-	-



Steel wire brush
Ø 115 mm



Steel wire brush
Ø 140 mm

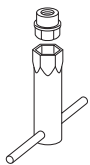

Attachment set for
steel wire brush
Ø 115 mm

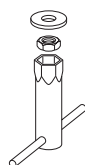

Attachment set for
steel wire brush
Ø 140 mm

MultiFlex

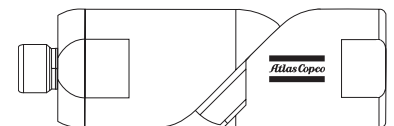

Die Grinders



Powerful and scatter-free

- Great power-to-weight ratio
- Speed governor for optimal grinding speed
- Safety start lever
- Unique spindle suspension that prevents burr chatter and minimizes vibration transfer

Die Grinders

G24-series

PRO die grinders are robust tools for grinding and finishing work in general industry.

G2414/G2424 are equipped with speed governors for optimal process speed together with a unique dampening system that are reducing the vibrations for the operator. Extreme working conditions place high demands on tools being used. We offer **G2417/G2427** with a heavy duty, all-steel body that will fulfil these requirements.



G2412-1



G2422-1



G2414



G2417

Model	Max free speed r/min	Max output kW	Length mm	Weight kg	Air cons. at max output l/s	Air cons. at free speed l/s	Rec. hose size mm	Air inlet thread BSP	Collet size		Ordering No.
									6 mm	1/4"	
Straight - Standard											
G2412-1	20000	0.35	178	0.5	10.3	13.0	10	1/4"	•	•	8423 0312 21
G2414-S085	8500	0.50	215	0.8	13.0	4.2	13	3/8"	•	•	8423 0312 58
G2414 S120	12000	0.75	215	0.8	16.0	5.3	13	3/8"	•	•	8423 0312 57
G2414 S150	15000	0.85	215	0.8	18.0	7.2	13	3/8"	•	•	8423 0312 56
G2414 S200	20500	0.90	215	0.8	19.0	9.0	13	3/8"	•	•	8423 0312 30
G2414 S250	25500	0.95	215	0.8	21.0	14.5	13	3/8"	•	•	8423 0312 29
Straight - All steel body											
G2417-S120	12000	0.66	213	1.2	13.8	4.0	13	3/8"	•	-	8423 0312 84
G2417-S180	18000	0.82	213	1.2	17.4	7.0	13	3/8"	•	-	8423 0312 83
G2417-S250	25000	0.86	213	1.2	18.5	11.0	13	3/8"	•	-	8423 0312 82
Straight extended											
G2422-1	20000	0.35	277	0.7	10.3	13.0	13	1/4"	•	•	8423 0312 47
G2424-S085	9400	0.44	315	1.0	13.0	4.2	13	3/8"	•	•	8423 0312 61
G2424 S120	12500	0.70	315	1.0	16.0	5.3	13	3/8"	•	•	8423 0312 60
G2424 S150	15500	0.75	315	1.0	18.0	7.2	13	3/8"	•	•	8423 0312 59
G2424 S200	20500	0.85	315	1.0	19.0	9.0	13	3/8"	•	•	8423 0312 55
G2424 S250	25500	0.90	315	1.0	21.0	14.5	13	3/8"	•	•	8423 0312 62
Straight extended - All steel body											
G2427-S250	25000	0.86	338	1.6	18.5	11.0	13	3/8"	•	-	8423 0312 86
G2427-S180	18000	0.82	338	1.6	17.4	7.0	13	3/8"	•	-	8423 0312 87
G2427-S120	12000	0.66	338	1.6	13.8	4.0	13	3/8"	•	-	8423 0312 88
Straight - Standard - Low Speed											
G2440	4300	0.55	216	0.9	5.7	7.0	10	1/4"	•	•	8423 0312 20

Die Grinders



G2451 is a lightweight, high-speed die grinder for light grinding and precision work. It has a robust aluminum housing with a plastic cover and comes with an exhaust air hose.

G2451

Model	Max free speed r/min	Max output kW	Length mm	Weight kg	Air cons. at free speed l/s	Rec. hose size mm	Air inlet thread BSP	Collet size		Ordering No.
								3 mm	1/8"	
G2451	80000	0.080	140	0.48	2.7	5	1/4"	•	•	8423 0313 01

Hose included

Accessories

Collet complete

For model G2412, G2414, G2422, G2424	Ordering No.
3 mm	4150 1049 81
6 mm	4150 1049 83*
8 mm	4150 1049 84
1/8"	4150 1049 85
1/4"	4150 1049 88*

*Collet included with tool

For model G2451	Ordering No.
3 mm	4112 1380 00*
1/8"	4112 1381 00*
1/12"	4112 1381 01

*Collet included with tool

For model G2417, G2427	Ordering No.
Collets	
Collet Ø 1/4"	4150 0076 00
Collet Ø 3 mm	4150 0081 00
Collet Ø 5 mm	4150 0075 01
Collet Ø 6 mm	4150 0075 00
Collet Ø 8 mm	4150 0074 00
Collet nut	4150 0760 00
Collet holder and collet nut	4110 0844 90
Extension 75 mm (3")	4150 0674 00

Productivity Kits

Model	Economical air flow	Hose, 5 m	Coupling	Lubrication	Ordering No.
For percussive tools and grinders with 3/8" BSP air inlet incl. whip hose					
MIDI Optimizer F/RD EQ10-R13-W	21 l/s	Rubber 13 mm	ErgoQIC 10	Yes	8202 0850 14
For percussive tools and grinders, incl. whip hose, no tool nipple included					
MIDI Optimizer F/RD EQ10-R13-W	21 l/s	Rubber 13 mm	ErgoQIC 10	Yes	8202 0850 15
For grinders and nutrunners with 3/8" BSP air inlet					
MIDI Optimizer F/RD EQ10-T13	21 l/s	Turbo 13 mm	ErgoQIC 10	Yes	8202 0850 17
For grinders and nutrunners with 1/2" BSP air inlet					
MIDI Optimizer F/R EQ10-T13	21 l/s	Turbo 13 mm	ErgoQIC 10	No	8202 0850 04
MIDI Optimizer F/RD EQ10-T13	21 l/s	Turbo 13 mm	ErgoQIC 10	Yes	8202 0850 13

Die Grinders

Reference table

Tools and abrasives for normal grinding applications

Grinding applications	Grinders					
	Die grinders	Vertical grinders	Geared turbine grinders	Angle grinders	Straight grinders	Sanders
Die grinding with:						
• rotary burr	•					
• mounted point	•					
Rough grinding with:						
• straight-sided wheel					•	
• depressed-center wheel		•	•	•		
• cup wheel		•	•			
• cutting-off wheel		•	•	•		
• mounted point	•					
• cone wheel					•	
Surface grinding with:						
• coated abrasive, dry sanding		•	•	•		•
• coated abrasive, wet sanding				•		
• nylon-coated abrasive	•	•		•		
• lambswool bonnet, etc.				•		
• wire brushes		•	•			

Productivity and grinding economy

Manpower and abrasives together account for about 90% of the total cost of grinding with handheld equipment. Wages alone make up the major part of manpower costs: often as much as 80%, or nearly half of total costs. Time is de nitely money. In other words, the time taken to complete the grinding task is crucially important. Reducing this time will lead to in- creased productivity and cost savings.

The main factors affecting grinding time are:

- Grinder output
- Feed force
- Operator stress and physical strain
- Time spent replacing worn abrasives
- Accessibility.

Grinder output is vital for high material removal, and is thus probably the single most important factor in total grinding economy. Yet actual performance that really exploits full grinder output or power, requires high feed force and good operator technique.

This, in turn, presupposes the correct use of quality abrasives for maximum material removal and minimum wheel wear. The ratio of material removal to abrasive wear depends on the right choice here. Based on the materials involved and tool output, it's possible to work out in advance which abra- sive is needed.

There is therefore a direct correlation between good overall grinding economy and the right choice of equipment: quality tools and abrasives suited to the job in hand. This equipment should be seen as an investment in long-term productivity, not as a short-term cost. Ergonomic tool design can greatly contribute to this.

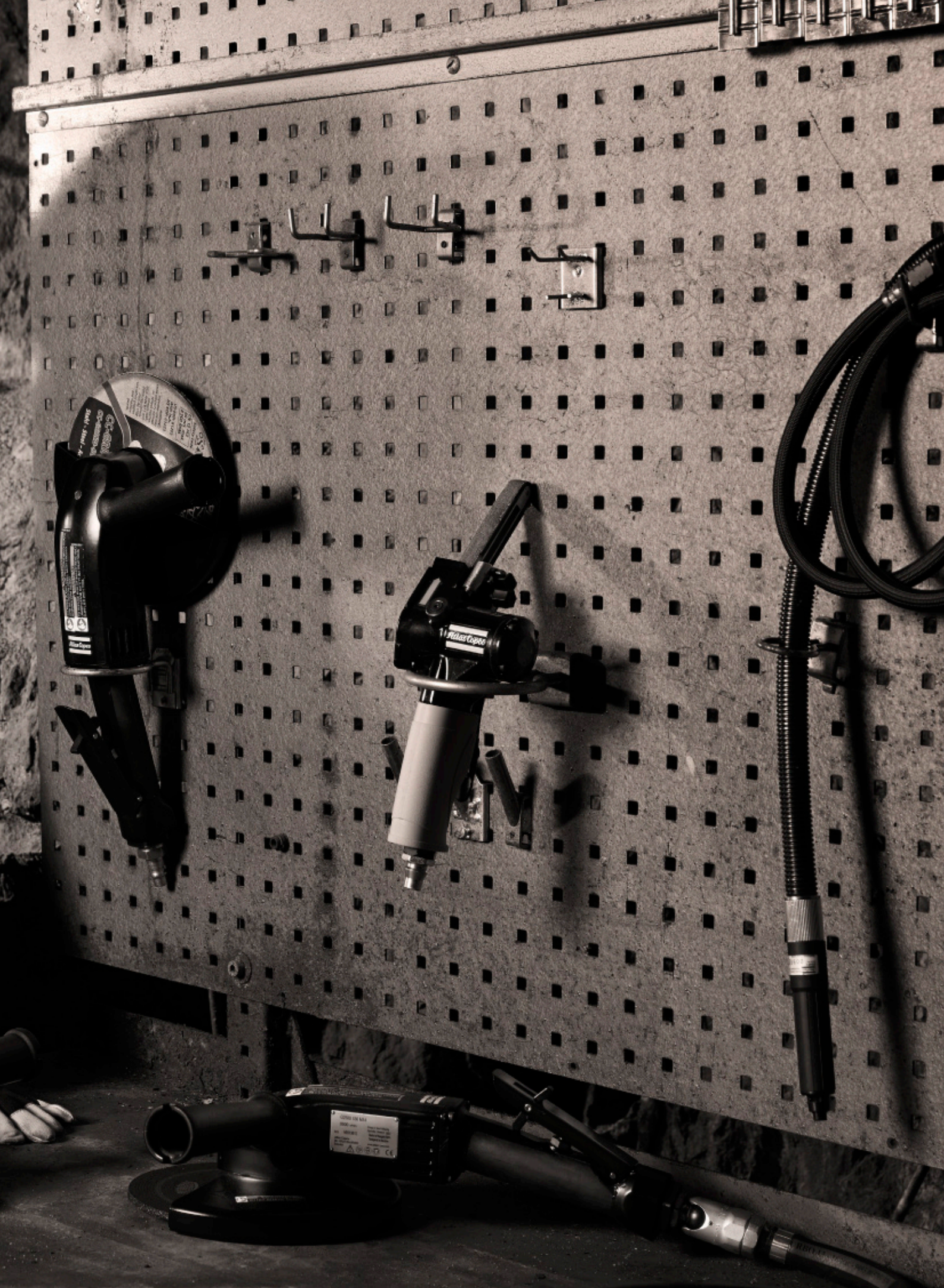

A close-up, black and white photograph showing a person's hand holding a dual-disc orbital sander. The sander has a white handle with safety icons (a triangle with an exclamation mark and a circle with a slash) and a black body. It is equipped with two discs: a top black disc and a larger bottom white disc. The sander is being used on a dark, perforated surface, likely a car's interior. The text "Sanding and polishing" is overlaid in white on the left side of the image.

Sanding and polishing

For the optimal **surface finish!**

- Great power-to-weight ratio
- Speed governor for optimal sanding speed
- Rubber grip on handle for insulation and comfort
- Safety start lever
- Spot suction kit available for clean and healthy working environment

Sanding and polishing

Angle sanders

The **G2588 Angle Sander** is suitable for rough sanding when more power is needed. Light and powerful, this is a powerful tool for the application.

Focus on operator ergonomics and productivity Available in two speeds and spindle threads.



G2588

Model	Max free speed r/min	Max output kW	Max pad dia	Spindle thread	Spindle length mm	Weight kg	Height over spindle mm	Air cons. at max output l/s	Air cons. at free speed l/s	Rec. Hose Size mm	Air inlet thread BSP	Ordering No.
G2588 S066	6600	1.7	230	UNC 5/8"	24.5	2.4	87	32	17	16	1/2	8423 0132 80
G2588 S085-M14	8500	1.7	180	M14	21	2.4	87	32	17	16	1/2	8423 0132 81

Sanding and polishing

Belt sanders

G2410/G2420 are suitable for precision sanding where access is difficult with conventional sanders.

The head rotation provides a versatile solution for many applications.



G2410

G2420

Model	Max free speed r/min	Max output kW	Belt speed m/min	Belt dimension mm	Weight kg	Air cons. l/s	Rec. hose size mm	Air inlet thread BSP	Ordering No.
G2410	25000	275	1400	13x305	0.9	10	10	1/4"	8423 0304 10
G2410 Kit	25000	275	1400	13x305*	0.9	10	10	1/4"	8423 0304 11
G2420	22000	350	1500	19x520	1.0	11	10	1/4"	8423 0304 20

*13x305 std, but also includes 6X305 and 13x305 felt belt arm

Sanding belt kit G2410	Grit size			
	40+	60+	80+	120+
3M sanding belt kit 20 pcs, 6x305mm (1/4"x12")	4170 1208 00	4170 1208 02	4170 1208 03	4170 1208 04
3M sanding belt kit 20 pcs, 13x305mm (1/2"x12")	4170 1208 05	4170 1208 06	4170 1208 07	4170 1208 08
Sanding kit G2420				
3M sanding belt kit 20 pcs, 19x520mm (3/4"x20-1/2")	4170 1208 13	4170 1208 14	4170 1208 15	4170 1208 16

Felt belt kit G2410	Coars	Medium	Very fine
3M Scotch-brite felt belt kit 10pcs, 13x305mm (1/2"x12")	4170 1210 00	4170 1210 01	4170 1210 02

G2410 Accessories	Ordering No.
Contact arm sanding belts 13 x 305mm (1/2"x12")(std arm)	4112 3007 88
Contact arm sanding belts 3 & 6 x 305mm (1/8" & 1/4"x12")	4112 3007 78
Contact arm felt belts 13 x 305mm (1/2"x12")	4112 3007 79
Service kit motor	4081 0501 90
Service kit general	4081 0502 90
Service kit belt support	4081 0503 90

G2420 Accessories	Ordering No.
Contact arm sanding belts 19 x 520mm (3/4"x20-1/2")(std arm)	4112 3008 83
Contact arm sanding belts 19x460mm (3/4"x18")	4112 3008 81
Service kit motor	4081 0520 90
Service kit general	4081 0519 90
Service kit belt support	4081 0521 90

Sanding and polishing

Pistol sanders 175-270 W

Pistol grip sanders for pad size 75 to 125 mm. **G2502** is a powerful sander for heavy sanding, **G2302** is a small sander for lighter sanding jobs. Both models are reliable, durable and easy to work with.



G2302



G2502



G2302-KIT

Model	Max free speed r/min	Max output kW	Max pad dia mm	Weight kg	Spindle thread	Air cons. l/s	Rec. hose size mm	Air inlet thread BSP	Ordering No.
G2302	17000	0.175	75	0.6	UNC 1/4"	9	10	1/4"	8423 0312 14
G2302 KIT	17000	0.175	75	0.6	UNC 1/4"	9	10	1/4"	8423 0312 15
G2502	12000	0.270	125	1	UNF 3/8"	12	10	1/4"	8423 0312 05

Sanding and polishing

Random orbital sanders

G2438 orbital sanders are ideal for precise and efficient sanding for fine surfaces using one hand..

The tools are compact with a composite housing. With three different orbital diameters as well as different dust suction solutions, the range covers virtually every need.



G2438-N - No suction



G2438-C - Central suction



G2438-I - Self suction

Model	Max free speed r/min	Max output W	Max pad dia mm	Orbit dia mm	Weight kg	Spindle thread	Air cons. at free speed l/s	Rec. hose size mm	Air inlet thread BSP	Extraction			Ordering No.
										No suction	Central suction	Self suction	
G2428-10	9000	180	150	10	1.5	UNF 5/16"	9	10	1/4"	•	-	-	8423 2810 16
G2438-6.3N	12000	160	150	2.5	0.9	UNF 5/16"	9	10	1/4"	•	-	-	8423 0313 10
G2438-6.5N	12000	160	150	5	0.9	UNF 5/16"	9	10	1/4"	•	-	-	8423 0313 05
G2438-6.10N	12000	160	150	10	0.9	UNF 5/16"	9	10	1/4"	•	-	-	8423 0313 12
G2438-6.3I	12000	160	150	2.5	1	UNF 5/16"	9	10	1/4"	-	-	•	8423 0313 20
G2438-6.5I	12000	160	150	5	1	UNF 5/16"	9	10	1/4"	-	-	•	8423 0313 15
G2438-6.10I	12000	160	150	10	1	UNF 5/16"	9	10	1/4"	-	-	•	8423 0313 17
G2438-6.3C	12000	160	150	2.5	0.9	UNF 5/16"	9	10	1/4"	-	•	-	8423 0313 30
G2438-6.5C	12000	160	150	5	0.9	UNF 5/16"	9	10	1/4"	-	•	-	8423 0313 25
G2438-6.10C	12000	160	150	10	0.9	UNF 5/16"	9	10	1/4"	-	•	-	8423 0313 27

Velcro pad included with tool

Accessories

Model	Ordering No.
Pads for G2438	
125 mm Velcro 6 hole	4112 6106 04
125 mm Vinyl no hole	4112 6106 01
125 mm Velcro no hole	4112 6106 03
150 mm Velcro 6 hole	4112 1369 00
150 mm Velcro no hole	4112 1363 00
Pads for G2428-10	
150 mm Velcro 6 hole	4112 6103 16
150 mm Vinyl 6 hole	4112 6105 06
150 mm Velcro no hole	4112 6102 10
150 mm Vinyl no hole	4112 6104 00

Sanding and polishing

Angle polishers

G2406



G2406/7 polishers are designed to be powerful and robust.

These tools can be used with lambswool pads and various sponges for an optimal surface finish.



G2407

Model	Max free speed r/min	Max output kW	Rec. pad dia mm	Spindle thread	Spindle length mm	Weight kg	Air cons. at free speed l/s	Rec. hose size mm	Air inlet thread BSP	Ordering No.
G2406	2000	350	125-200	UNF 3/8"	17	1.4	10	10	1/4"	8423 0304 88
G2407 M14	3400	350	125-200	M14	12	1.4	10	10	1/4"	8423 0304 55
G2407	3400	350	125-200	UNF 3/8"	17	1.4	10	10	1/4"	8423 0304 77

Accessories

Velcro pads	Ordering No.
150 mm Velcro pad, thread UNC 5/8". Maximum speed 2 500 r/min. To be used together with Velcro sponge heads or Velcro lambswool bonnet.	4112 6092 15
Lambswool bonnet 150 mm with Velcro fitting. Maximum speed 2 500 r/min.	4112 6093 15
150 Velcro sponge head, maximum speed 2 500 r/min, White, Dense, firm sponge head for compounding 2-pack paint systems. Excellent result with all leading makes of compound and polish.	4112 6094 15
150 mm Velcro sponge head, maximum speed 2 500 r/min, Blue Softer sponge, more open cell, for polishing and compounding of cellulose, acrylics etc.	4112 6096 15
150 mm Velcro sponge head, maximum speed 2 500 r/min, Yellow coarse sponge, open cell, for aggressive compounding including oxidized paintwork.	4112 6099 15
Threaded pads	
150 mm white sponge head pad, thread UNC 5/8". Maximum speed 4 000 r/min.	4112 6100 15
150 mm blue sponge head pad, thread UNC 5/8". Maximum speed 4 000 r/min.	4112 6101 15
180 mm soft plastic UNC 5/8" and spanner. Maximum speed 8 000 r/min.	4170 0756 80
UNF 3/8"-24 x M14 Spindle thread adaptor. (To be used with M14 threaded pads.)	4021 0435 00
UNF 3/8" x UNC 5/8" Spindle thread adaptor. (To be used with 5/8" threaded pads. Included with tool.)	4021 0434 00
Exhaust air hose	4150 1077 80



Productivity Kit

Model	Economical airflow	Hose 5 m	Coupling	Lubrication	Ordering No.
MIDI Optimizer F/RD EQ10-R13-W	21 l/s	Rubber 13 mm	ErgoQIC 10	Yes	8202 0850 15

Percussive Tools



We have an ergonomic solution

- No additional tools required for changing needles.
- Lightweight tool, offering one-handed operation.
- Low vibration improves operator control and reduces risk of vibration-related injuries.
- Low vibration, heavy duty design.



Flexibility: Atlas Copco needle scalers convert to chisel scalers in seconds. Low vibration needle and chisel scalers can be fitted with vacuum shrouded front tubes to control dust where necessary.

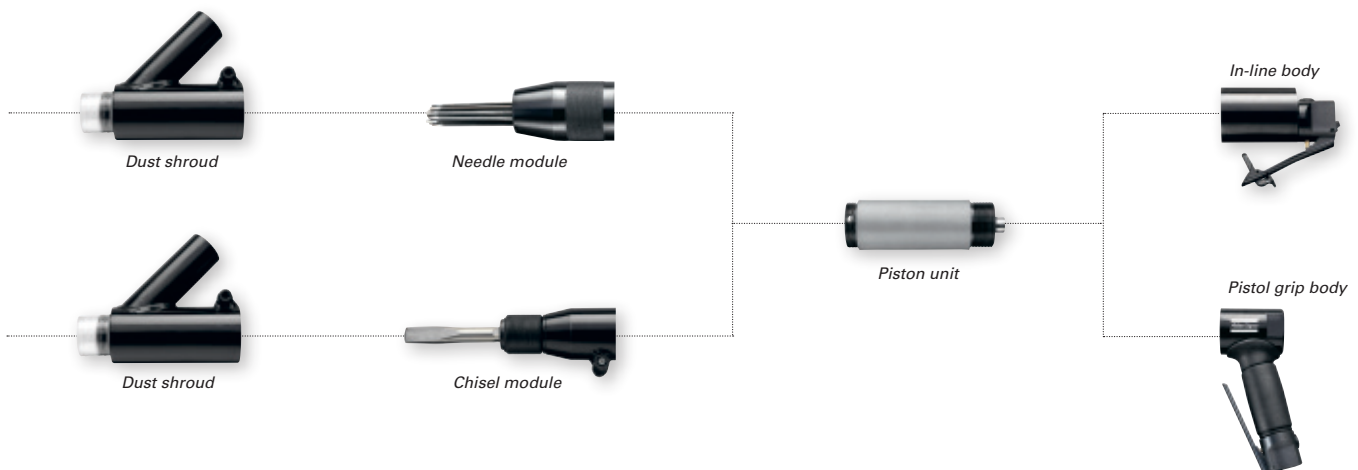

Percussive Tools

Weld flux removal tools

PRO weld flux removal tools and scalers are perfect for tough applications involving removal of weld flux or paint and rust. The all-steel construction of the tools ensures durability.

The **P2540**, **P2541**, **P2550** and **P2551** tools are all vibration damped and available in in-line and pistol grip configurations.

The compact **P2520** is a good choice for weld flux removal.



P2520



P2540



P2541



P2550



P2551

Model	Blows Hz	Stroke mm	Energy per blow J	Length mm	Weight kg	Bushing mm	Air cons. l/s	Rec. hose size mm	Air inlet thread BSP	Bushing square type	Ordering No.
P2520	90	16	1.6	182	1	12.7	2.4	6.3	1/4"	•	8425 0103 15
P2540	40	11	-	340	2.7	-	8	10	1/4"	-	8425 0103 40
P2541	40	11	-	370	2.35	-	8	10	1/4"	-	8425 0103 41
P2550	40	11	3	395	3.2	12.7	8	10	1/4"	•	8425 0103 50
P2551	40	11	3	435	2.95	12.7	8	10	1/4"	•	8425 0103 51

Percussive Tools

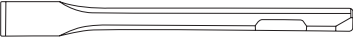
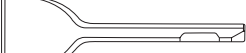
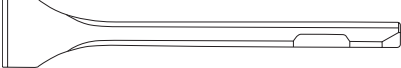
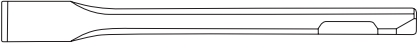
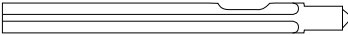
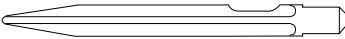
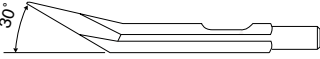
	Designation	Blade width	Chisel length	For tool	Ordering No.
	Flat chisel	19 mm	178 mm	P2550/51	3085 0400 47
	Wide flat chisel	64 mm	178 mm	P2550/51	3085 0400 48
	Flat chisel	19 mm	254 mm	P2550/51	3085 0400 49
	Weld flux chisel	35 mm	178 mm	P2550/51	3085 0400 50
	Thin chisel	6 mm	203 mm	P2550/51	3085 0400 51
	Chisel blank	12.7 mm	155 mm	P2520	3085 0400 00
		12.7 mm	200 mm	P2520	3085 0400 01
		12.7 mm	250 mm	P2520	3085 0400 02
	Flat chisel	14.8 mm	155 mm	P2520	3085 0400 03
		14.8 mm	200 mm	P2520	3085 0400 04
		14.8 mm	250 mm	P2520	3085 0400 05
	Flux chisel	25 mm	155 mm	P2520	3085 0400 06
		25 mm	200 mm	P2520	3085 0400 07

Needles

Designation	Length mm	Ordering No.
Set of 19 needles		
Steel standard	180	3512 0071 90
Stainless steel, flat ends	180	3512 0072 90
Beryllium copper flat ends	180	3512 0073 90

Modules*

Designation	Ordering No.
Dust shroud	4112 1546 04
In-line body	4112 3009 93
Pistol grip body	4112 3009 94
Chisel module	4112 1554 90
Needle module	4112 1555 90

* See illustrations below

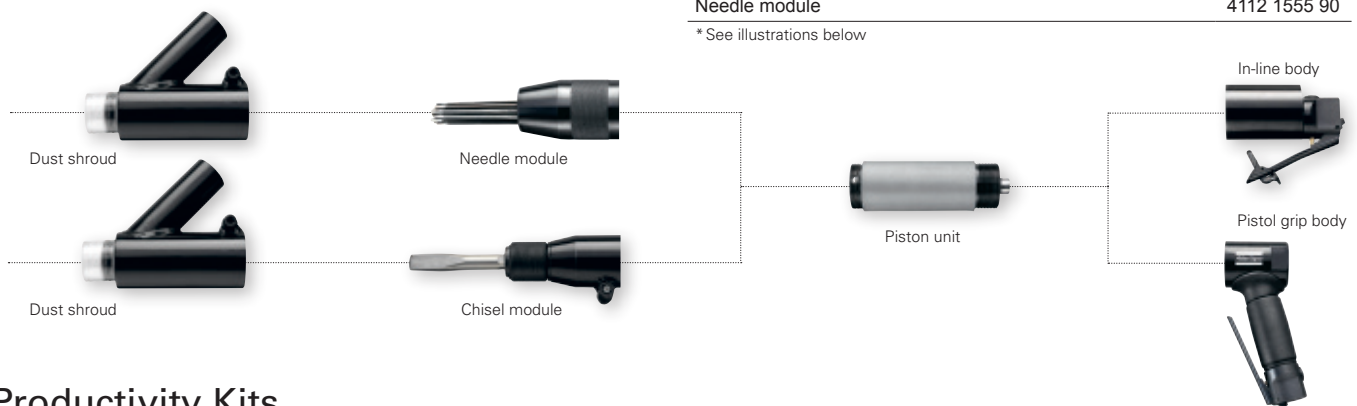

Productivity Kits

Model	Economical air flow	Hose 5 m	Coupling	Lubrication	Ordering No.
For percussive tools and grinders with 3/8" BSP air inlet incl. whip hose					
MIDI Optimizer F/RD EQ10-R13-W	21 l/s	Rubber 13 mm	ErgoQIC 10	Yes	8202 0850 14
For percussive tools and grinders, incl. whip hose, no tool nipple included					
MIDI Optimizer F/RD EQ10-R13-W	21 l/s	Rubber 13 mm	ErgoQIC 10	Yes	8202 0850 15

Percussive Tools



P2535-H

Chipping Hammers

PRO chipping hammers are available as pistol grip versions for lighter applications.

The bigger D-handle models are suitable for heavy duty applications.



P2530-H



P2531-H



P2536-H



P2539-H

Model	Blows Hz	Stroke mm	Energy per blow J	Length mm	Weight kg	Bushing mm	Air cons. l/s	Rec. hose size mm	Air inlet thread BSP	Bushing type		Ordering No
										Hex	Round	
P2530-H	60	38	1.3	140	1.1	10.2	5.8	10	1/4"	●	-	8425 0206 15
P2530-R	60	38	1.3	140	1.1	10.2	5.8	10	1/4"	-	●	8425 0206 16
P2531-H	50	45	4.5	193	1.5	10.2	6.7	10	1/4"	●	-	8425 0206 20
P2531-R	50	45	4.5	193	1.5	10.2	6.7	10	1/4"	-	●	8425 0206 21
P2535-H	50	45	4.5	273	2.5	12	7	10	1/4"	●	-	8425 0206 30
P2535-R	50	45	4.5	273	2.5	14	7	10	1/4"	-	●	8425 0206 31
P2536-H	50	25	8.1	301	5	17.5	10	13	3/8"	●	-	8425 0206 35
P2539-H	28	102	21.2	425	6.8	17.5	11	13	3/8"	●	-	8425 0206 50

Productivity Kits

Model	Economical air flow	Hose 5 m	Coupling	Lubrication	Ordering No.
For percussive tools and grinders with 3/8" BSP air inlet incl. whip hose					
MIDI Optimizer F/RD EQ10-R13-W	21 l/s	Rubber 13 mm	ErgoQIC 10	Yes	8202 0850 14
For percussive tools and grinders, incl. whip hose, no tool nipple included					
MIDI Optimizer F/RD EQ10-R13-W	21 l/s	Rubber 13 mm	ErgoQIC 10	Yes	8202 0850 15

Selection guide – Chipping & Scaling

	Scaler	Light chipping hammer	Medium chipping hammer	Large chipping hammer
Slagging welds	●	●		
Fettling castings		●	●	●
Joint and root chipping			●	●
Sheet-metal cutting		●	●	
Rust and paint removal	●*	●		
Hole-making or light demolition			●	
Trimming concrete	●	●		

*Needle scaler

Percussive Tools

Other tools

P2505 engraving pen will give a precise result on any hard material, such as aluminum, steel or glass. The needle is easy to change and the tool is small yet durable.

C1050 allows you to cut through material with ease. Due to its geared mechanism the tool will not stall as a conventional air saws commonly do.



P2505



C1050

Model	Max free speed r/min	Length mm	Weight kg	Air cons. l/s	Rec. hose size mm	Air inlet thread BSP	Ordering No.
P2505	190	175	0.12	0.6	3.2	1/8"	8425 0102 72





Model	Stroke per minute	Stroke length mm	Blade shank opening mm	Length mm	Weight kg	Air cons. l/s	Rec. hose size mm	Air inlet thread BSP	Ordering No.
C1050	10500	5	5	148	0.52	2.2	6.3	1/4"	8424 1110 50



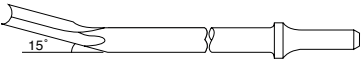

Accessories

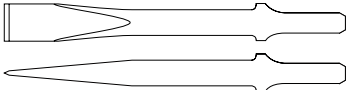
Model	Ordering No.
P2505 Needle and small parts kit	4081 0068 90

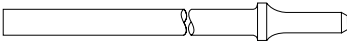
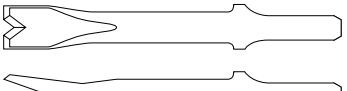
C1050	Ordering No.
Saw Blade 32 teeth 10pcs	4112 3008 45
Saw Blade 24 teeth 10pcs	4112 3008 46

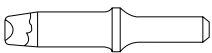
Accessories

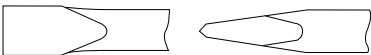
	Designation	Width	Length	For tool	Ordering No.
		25 mm	250 mm	P2520, P2521, P2522	3085 0400 08
	Plate cutting chisel	13 mm	208 mm	P2530-R, P2531-R	3085 0400 09
		13 mm	208 mm	P2530-H, P2531-H	3085 0400 10
	Double edge plate cutting chisel	19 mm	155 mm	P2530-R, P2531-R	3085 0400 11
		19 mm	155 mm	P2530-H, P2531-H	3085 0400 12
	Flat chisel	20 mm	178 mm	P2530-R, P2531-R	3085 0400 13
		20 mm	178 mm	P2530-H, P2531-H	3085 0400 14
	Point chisel	3.2 mm	178 mm	P2530-R, P2531-R	3085 0400 15
		3.2 mm	178 mm	P2530-H, P2531-H	3085 0400 16
	Rivet cutter	15 mm	150 mm	P2530-R, P2531-R	3085 0400 17
		15 mm	150 mm	P2530-H, P2531-H	3085 0400 18
	Chisel blank	12.7 mm	182 mm	P2530-R, P2531-R	3085 0400 19
		12.7 mm	182 mm	P2530-H, P2531-H	3085 0400 20
	Spot weld chisel	19 mm	145 mm	P2530-R, P2531-R	3085 0400 21
		19 mm	145 mm	P2530-H, P2531-H	3085 0400 22

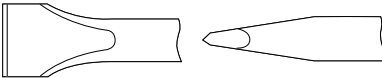
	Designation	Width	Length	For tool	Ordering No.
	Rivet snap 3 Rivet size 3 mm		90 mm	P2530-R, P2531-R	3085 0400 23
	Rivet snap 4 Rivet size 4 mm		90 mm	P2530-R, P2531-R	3085 0400 24
	Rivet snap 5 Rivet size 5 mm		90 mm	P2530-R, P2531-R	3085 0400 25
	Rivet snap 6 Rivet size 6 mm		90 mm	P2530-R, P2531-R	3085 0400 26
	Chisel blank	16 mm	250 mm	P2535-R	3085 0400 27
		16 mm	300 mm	P2535-R	3085 0400 28
		16 mm	250 mm	P2535-H	3085 0400 29
		16 mm	300 mm	P2535-H	3085 0400 30
		20 mm	250 mm	P2536-R	3085 0400 31
		20 mm	300 mm	P2536-R	3085 0400 32
		20 mm	250 mm	P2536-H, P2539-H	3085 0400 33
		20 mm	300 mm	P2536-H, P2539-H	3085 0400 34
	Flat chisel	16 mm	200 mm	P2535-R	3085 0400 35
		16 mm	200 mm	P2535-H	3085 0400 36 Hex 11.8 back end
		20 mm	250 mm	P2536-R	3085 0400 37
		20 mm	250 mm	P2536-H, P2539-H	3085 0400 38
	Point chisel	16 mm	200 mm	P2535-R	3085 0400 39
		16 mm	200 mm	P2535-H	3085 0400 40
		20 mm	250 mm	P2536-R	3085 0400 41
		20 mm	250 mm	P2536-H, P2539-H	3085 0400 42
	Wide flat chisel	25 mm	200 mm	P2535-R	3085 0400 43
		25 mm	200 mm	P2535-H	3085 0400 44
		32 mm	250 mm	P2536-R	3085 0400 45
		32 mm	250 mm	P2536-H, P2539-H	3085 0400 46 Hex 14.5 back end

Air preparation units



Get the most out of your tools

- Get maximum productivity from your tools
- Extend the tool lifetime
- Lubricate your air tools
- Range covers all pneumatic tool needs



Use our **planner** to select the correct FRL, couplings, connectors and hoses for your air line installation and improve the performance and durability of your pneumatic tools!

Selection guide

Mini	Midi	Maxi
		
0-9 l/s	9-31 l/s	31-82 l/s

Air Preparation Units

MINI – Range



Air preparation unit **MINI-Range** main application is to prepare the air for pneumatic components.

MINI-K units have a 1/4" BSP connection thread, are ideal for small tooling applications.

Working temperature
-10°C to 50°C

Max Working Pressure
10 bar (232 psi)

DESCRIPTION
Sinter filter centrifugal principle, diaphragm-type pressure with relieving feature, lubricator with automatic oil filling.

Medium
Compressed air and neutral gases

SUPPLY Pressure
1.5 - 16 bar at inlet
0.5 - 10 bar at outlet

FILTER ELEMENT
5µm

Model	Maximum air flow l/s	Bowl material	Filter condensate drainage	Max condensate capacity cm ³	Max oil capacity cm ³	Weight kg	Ordering No.
Filters							
MINI-FIL-1/4-BSP	37	Plastic, PC with PA bowl guard	Automatic	10	-	0.62	4221 0001 31
Regulators							
MINI-REG-1/4-BSP	34	-	-	-	-	0.67	4221 0001 39
Lubricators							
MINI-LUB-1/4-BSP	46	Plastic, PC with PA bowl guard	-	-	40	0.64	4221 0001 47
Filter/regulator							
MINI-F/R-1/4-BSP	34	Plastic, PC with PA bowl guard	Automatic	10	-	1.05	4221 0001 55
Filter/regulator+lubricator							
MINI-FRL-1/4-BSP	29	Plastic, PC with PA bowl guard	Automatic	10	40	0.78	4221 0001 63

NOTE: All separate units, mounting brackets, assembly kits and pressure gauges need to be ordered separately. MINI-F/R-1/4-BSP and MINI-FRL-1/4-BSP are delivered with gauge.

Air Preparation Units

MIDI – Range 1/2" – BSP



The **MIDI Range** is suitable for more than 90% of the Atlas Copco tool range and is the best choice for assembly tools, percussive tools, drills, nibblers and grinders up to Turbo.

The **MIDI Optimizer** has a 1/2" BSP connection thread and a housing and bowl of high-tech polymer.

Working temperature

-10 °C to 50°C

+2°C to +60°C at 10 bar for filters

NOTE: For dry compressed air, ice formation must be avoided.

DESCRIPTION

Sinter filter centrifugal principle, diaphragm-type pressure with relieving feature, lubricator with automatic oil filling.

Medium

Compressed air, neutral gases

SUPPLY Pressure

1.5 - 16 bar at inlet

0.5 - 10 bar at outlet

FILTER ELEMENT

5µm

Model	Maximum air flow l/s	Bowl material	Filter condensate drainage	Max condensate capacity cm ³	Max oil capacity cm ³	Weight kg	Ordering No.
Filters							
MIDI-FIL-1/2-BSP	59	Plastic, PC with PA bowl guard	Automatic	31	-	0.4	4221 0001 33
Regulators							
MIDI-REG-1/2-BSP	83	-	-	-	-	0.49	4221 0001 41
Lubricators							
MIDI-LUB-1/2-BSP	134	Plastic, PC with PA bowl guard	-	-	80	0.41	4221 0001 49
Filter/Regulator							
MIDI-F/R-1/2-BSP	83	Plastic, PC with PA bowl guard	Automatic	31	-	0.66	4221 0001 57
Filter/Regulator/Lubricator							
MIDI-FRL-1/2-BSP	65	Plastic, PC with PA bowl guard	Automatic	31	80	1.16	4221 0001 65

NOTE: All separate units, mounting brackets, assembly kits and pressure gauges need to be ordered separately. MIDI-F/R-1/2-BSP and MIDI-FRL-1/2-BSP are delivered with gauge.

Air Preparation Units

MAXI – Range 3/4" – 1"



The high flow **MAXI** air preparation unit's main application is to prepare the air for pneumatic tools which are large air consumers when long distribution hoses and multi connectors are used. A good example is Atlas Copco Turbo grinders.

Working temperature

-10°C to 50°C

NOTE: For dry compressed air, ice formation must be avoided.

Max Working Pressure

10 bar (232 psi)

DESCRIPTION

Sinter filter centrifugal principle, diaphragm-type pressure with relieving feature, lubricator with automatic oil filling.

Medium

Compressed air, neutral gases.

SUPPLY Pressure

1.5 - 16 bar at inlet

0.5 - 10 bar at outlet

FILTER ELEMENT

5µm

Model	Maximum air flow l/s	Bowl material	Filter condensate drainage	Max condensate capacity cm ³	Max oil capacity cm ³	Weight kg	Ordering No.
Filters							
MAXI-FIL-3/4-BSP	134 ^a	Plastic, PC with PA bowl guard	Automatic	69	-	0.9	4221 0001 35
MAXI-FIL-1-BSP	134 ^a	Plastic, PC with PA bowl guard	Automatic	69	-	0.8	4221 0001 37
Regulators							
MAXI-REG-3/4-BSP	237	Plastic, PC with PA bowl guard	-	-	-	1.02	4221 0001 43
MAXI-REG-1-BSP	237	Plastic, PC with PA bowl guard	-	-	-	0.95	4221 0001 45
Lubricators							
MAXI-LUB-3/4-BSP	234	Plastic, PC with PA bowl guard	-	-	181	0.95	4221 0001 51
MAXI-LUB-1-BSP	234	Plastic, PC with PA bowl guard	-	-	181	0.89	4221 0001 53
Filter/regulator							
MAXI-F/R-3/4-BSP	217	Plastic, PC with PA bowl guard	Automatic	69	-	1.29	4221 0001 59
MAXI-F/R-1-BSP	217	Plastic, PC with PA bowl guard	Automatic	69	-	1.29	4221 0001 61
Filter/Regulator/Lubricator							
MAXI-FRL-3/4-BSP	200	Plastic, PC with PA bowl guard	Automatic	69	181	1.29	4221 0001 67
MAXI-FRL-1-BSP	200	Plastic, PC with PA bowl guard	Automatic	69	181	1.23	4221 0001 69

^a 8 bar inlet pressure, 1 bar pressure drop.

NOTE: All separate units, mounting brackets, assembly kits and pressure gauges need to be ordered separately. MAXI-F/R-3/4-BSP, MAXI-F/R-1-BSP, MAXI-FRL-3/4-BSP and MAXI-FRL-1-BSP are delivered with gauge.

Accessories: Maxi FRL stand, metal bowl, pressure language, ball valve are all on accessory page.

SINGLE FILTER ACCESSORIES

Designation	Ordering No.
Semi/Manual Drain: for MINI series	4221 0001 75
Autodrain: for all three ranges	4221 0001 76
Metal filter bowl with level indicator and automatic drain (P1 max 10 bar)	
MINI series	4221 0002 04
MIDI series	4221 0002 05
MAXI series	4221 0002 07

SINGLE REGULATOR ACCESSORIES

Designation	Ordering No.
Pressure Gauge 1: Standard (Metal material) BSP	4221 0001 77
Pressure Gauge 1: Standard (Metal material) NPT	4221 0001 78
Pressure Gauge 2: Heavy Duty (Larger size in metal)	4221 0001 79

SINGLE LUBRICATOR ACCESSORIES

Designation	Ordering No.		
	MINI	MIDI	MAXI
Metal bowl with level indicator and fill valve (Die cast, Zinc)			
	4221 0001 80	4221 0001 81	4221 0001 82

FILTER, REGULATOR AND LUBRICATOR ACCESSORIES

Designation	Ordering No.
MINI	
Coupling kit - (Steel, for wall mounting, 1x)	4221 0001 83
Mounting bracket - (Steel, for control panel mounting, 1x)	4221 0001 84
Coupling kit - (for connecting F+R+L units, 1x)	4221 0001 85
MIDI	
Coupling kit - (Steel, for wall mounting, 1x)	4221 0001 86
Mounting bracket - (Steel, for control panel mounting, 1x)	4221 0001 87
Coupling kit - (for connecting F+R+L units, 1x)	4221 0001 88
MAXI	
Coupling kit - (Steel, for wall mounting, 1x)	4221 0001 89
Coupling kit - (for connecting F+R+L units, 1x)	4221 0001 90
Coupling kit - (Steel, for wall mounting, 1x)	4221 0002 00

NOTE: Control panel nut included in the bracket kit for all models.
The Auto Drain fits to the complete FRL range and is already factory mounted on the complete FRL range.

BALL VALVE (LOCKABLE)

Designation	Ordering No.
Size MINI	8202 1350 63
Size MIDI	8202 1350 64
Size MAXI 3/4"	8202 1350 65
Size MAXI 1"	8202 1350 66

NOTE: Control panel nut is included with the bracket.



Mounting bracket kit



Filter element



Pressure gauge



Ball valve

Air Preparation Units

Optimizer Air Tool Oil

Atlas Copco Optimizer air tool oil is a white, oil based lubricant for pneumatic tools. It has excellent antiwear properties and contains additives preventing oxidation and foaming. Optimizer air tool oil provides a better working environment, compared to conventional mist lubrication oils and is recommended when stringent demands are placed on the working environment.

- Provides a better working environment.
- Excellent antiwear properties.
- Minimizes wear on components.



Model	Ordering No.
Optimizer 0.5 liter	9090 0000 02
Optimizer 1 liter	9090 0000 04
Optimizer 4 liter	9090 0000 06

Technical Data

Temperature range	-25°C to +70°C
Density at 15°C	869 kg/m ³
Viscosity at 40°C	22 mm ² /s
Pour point	-48°C
Flash point COC	>170°C

SINGLE POINT LUBRICATOR DOSOL

Accurate lubrication for tools in intermittent service.

The Atlas Copco DOSOL system for direct lubrication is based on an injector pump which meters out the oil in exact doses, actuated by pulses of compressed air. The oil dosage can be regulated from a fraction of a drop to a full drop.

- **Exact amount** – Precision injector, adjustable for exact amount of oil.
- **Oil directly at the tool** – The oil is conveyed through a capillary tube directly to the lubrication point.

A single-point lubricator (SPL) consists of an injector pump fitted to a valve body, converting interruptions in compressed air flow into pulses. In the majority of cases, an oil bowl is fitted on each lubricator.

Every DOSOL SPL unit can be finely tuned to inject from 1 to 1/10 of a drop of oil in 40 steps (30 to 3 mm³). Every DOSOL SPL unit includes as standard a counter with a switch that allows the lubricator to operate every first, fifth or tenth tool cycle.

The adjusting knob features a positive stop at both maximum and minimum settings, which means that a zero setting is not possible.

The preset quantity of oil is supplied to the tool through a small-bore nylon tube inside the air hose. 7.5 m of oil-filled nylon tubing is included as standard.



MULTIPLE-POINT LUBRICATOR DOSOL

For supplying lubricant to an unlimited number of lubrication points on a machine or in a pneumatic system.

The DOSOL multiple-point lubricator (MPL) consists of a number of JECT 01 oil metering pumps assembled into a "package" with a common BASE base-plate. A stack may contain up to ten JECT 01 units. Several such assemblies may be used together.

- All oil pumps are supplied with oil via the BASE from an oil container or central oil reservoir. A line for pneumatic signals from the equipment to be lubricated is also connected to the BASE.

- The lubricant is conveyed through small-bore nylon tubing which should be ended with check valves.
- With the TEN counter the lubricator can be actuated every first, fifth or tenth tool cycle.

Every DOSOL MPL unit can be finely tuned to inject from 1 to 1/10 drop of oil in 40 steps (30 to 3 mm³). This helps to minimize the oil dose. The adjusting knob features a positive stop at both maximum and minimum settings, which means that zero setting is not possible.

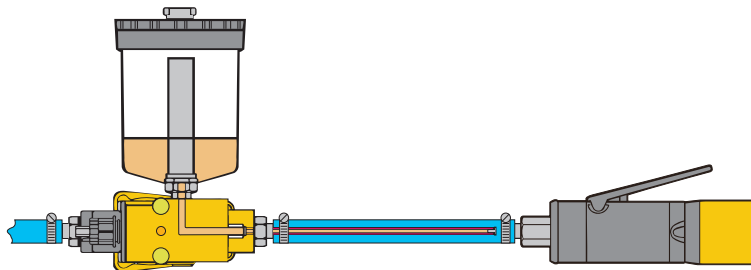

SINGLE-POINT LUBRICATOR, DOS

Model	Connection thread BSP in	Air flow l/s		Working pressure bar		Temperature range °C		Ordering No.
		min	max ^a	min	max	min	max	
DOS 15B-C ^b	1/2	2.3	45	3.2	10	-30°	+60°	8202 4201 73
DOS 15B-CR ^c	1/2	2.3	45	3.2	10	-30°	+60°	8202 4202 72
DOS 20B-C ^b	3/4	2.3	53	3.2	10	-30°	+60°	8202 4201 81
DOS 20B-CR ^c	3/4	2.3	53	3.2	10	-30°	+60°	8202 4202 80

^a At 6 bar and DP = 0.2 bar.

^b With counter and 7.5 m oil-filled nylon tubing.

^c With 0.3 l oil container counter and 7.5 m oil-filled nylon tubing.

Air Preparation Units

Lubricator DOSOL - accessories

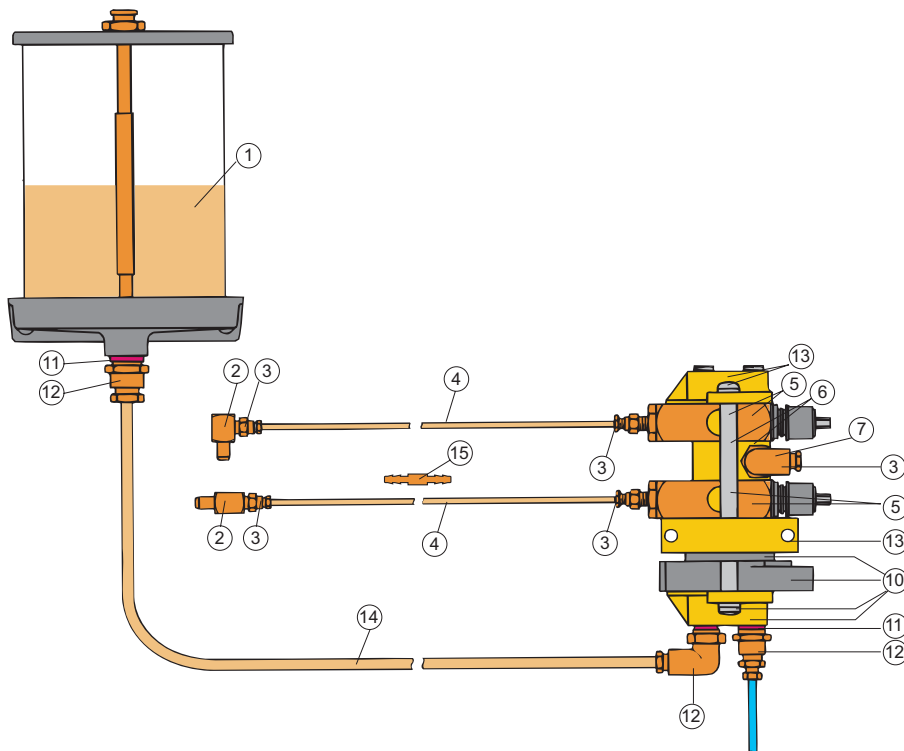

NOTE: When the counter TEN is used in MPL installations an intermediate, black plastic part is used (supplied with all TEN counters) between BASE and TEN.

FOR SINGLE POINT LUBRICATOR DOSOL

Designation	Ordering No.
Nylon tubing 3.2 mm outside diameter	
7.5 m, oil-filled	9090 1418 00
7.5 m, without oil	9090 1419 00
100 m, with oil	9090 1420 00
Barbed nipple for joining of 3.2 mm tubes	9090 1423 00
Check valve for outer end of nylon tubing, dia ext. 3.2 mm	9090 2050 00

MULTIPLE-POINT LUBRICATOR, BASE, JECT 01

Designation	BSP in	Ordering No.
BASE baseplate	Plate	8202 4205 04
	Oil port	1/4
	Air port	1/4
	Clamp	
	Oil port	1/4
	Air port	1/4
JECT 01 oil pump	Oil delivery port	1/8
		8202 4203 10

TEN-counter

When lubricating equipment with a very low air consumption or very short time in operation it may be difficult to set a sufficiently small dose of oil. In such cases a counter is connected underneath the base plate BASE. The oil pumps will then be actuated only on each, every fifth or every tenth air pulse. The air signal is connected to the clamp underneath the counter. Ordering No. 8202 4206 03

Side-ported air block kit

If all pumps are not to be actuated simultaneously, a signal block is installed between the oil pumps in the stack. The pumps below the signal block will then be actuated via the base plate BASE and those above it from a separate signal via the signal block. Ordering No. 8202 4206 03

Ref No. in figure	Designation	Ordering No.
1	Oil container 0.3 l for direct mounting 0.95 l for wall mounting (1/4" BSP female) 1.9 l for wall mounting (1/4" BSP female)	9090 1415 00 9090 1416 00 9090 1417 00
2	Check valve 1/8" BSPT 90° elbow male x 1/8" BSP female 1/8" BSPT, straight male x 1/8" BSP female	9090 1427 00 9090 1426 00
3	Male adapter 1/8" BSPT, straight for tube outer diameter 3.2 mm	9090 1425 00
4	Capillary tubing 7.5 m, outer dia. 3.2 mm prefilled with oil 7.5 m, outer dia. 3.2 mm without oil 100 m, outer dia. 3.2 mm with oil	9090 1418 00 9090 1419 00 9090 1420 00
5	JECT 01 kit ^a	8202 4203 10
6	Side-ported air block kit	9090 1424 00
7	Fiber packing for 1/8" BSP	0657 5742 00
10	Counter TEN kit	8202 4206 03
11	Fiber packing for 1/4" BSP	0657 5764 00
12	Male adapter 1/4" BSP, straight for tube outer diameter 8 mm	9090 0715 00
13	BASE kit	8202 4205 04
14	Nylon tube, outer diameter 8 mm (sold by the meter)	9030 0060 00
15	Barbed nipple for joining of nylon tubes outer diameter 3.2 mm	9090 1423 00
16	Nylon tube outer diameter 5 mm (sold by the meter)	9030 0059 00

^aWith high temperature Viton seals 8202 4203 15.

Inline Pressure Testing Equipment

Plug & Play

Atlas Copco Inline Testing Equipment

comes in EU, US and ASIA Profile Series.

The test equipment is :

1. Easy to Use
2. Fast and Reliable
3. Real Time Feedback Pressure at Tool Inlet



Model	Nip Standard	Max working pressure	Part Number
Atlas Copco IPT-SmartQic 08E	EURO STANDARD 7.6	16 bar	4221000496
Atlas Copco IPT-SmartQic 15E	EURO STANDARD 10.4	16 bar	4221000501
Atlas Copco IPT-SmartQic 08US	ISO 6150-B / US STANDARD	16 bar	4221000502
Atlas Copco IPT-SmartQic 10US	ISO 6150-B / US STANDARD	16 bar	4221000504
Atlas Copco IPT-SmartQic 15US	ISO 6150-B / US STANDARD	16 bar	4221000505
Atlas Copco IPT-SmartQic 10A	ASIA STANDARD 7.5 MM	16 bar	4221000506

Quick Couplings

Introduction

Ensure the highest air flow and lowest pressure drop of your pneumatic tools

Whenever tools or pneumatic equipment need to be changed, or you need to make quick connections of hoses to an air outlet, Atlas Copco couplings are the energy efficient and high productivity choice.

Energy efficiency

All Atlas Copco couplings are designed to ensure minimum pressure drop and thus reduce energy consumption.

Productivity

Exceptionally high air flow ensures full power to your tools.

Quality

Atlas Copco couplings are light and compact and the bodies are made of hardened steel, which provides long life in the toughest applications.

Ergonomics

The couplings from Atlas Copco features compact dimensions and low weight for the operator.

Safety

ErgoQIC and SmartQIC are vented safety versions to minimize the risk of sudden component separation and sound bang. The safety features are according to EN 983 and ISO 4414.

The range

Atlas Copco offers four product groups of quick couplings in many international standards:

- ErgoQIC - full flow coupling.
- SmartQIC - Safety vented coupling.
- QIC - Entry level coupling.
- Claw - High flow and durable coupling.

Selection Guide

Standard Type	Global standard				Euro standard			US standard / ISO 6150-B			Asia standard
	08	10		10AC	7.6 (7.4) mm	10.4 mm	15 mm	5.3 mm (1/4")	8.2 mm (3/8")	11 mm (1/2")	7.5
Atlas Copco ErgoQIC	08	10		10AC	08E	15E		08US	10US	15US	10 A
Atlas Copco SmartQIC					08E	15E		08US	10US	15US	10 A
Atlas Copco QIC				10			15	08			
Atlas Copco Claw			Claw								
CEJN					320	410		310	430	550	315
Oetiker					SC C			SC B1	SC E	SC H	SC D
Tema				1650	1600	1700	1750	1400			
Rectus				33	25/26	27	34	23/24	30	37	13
Prevost					ESC/ERC07			IRC/ISC06	IRC/ISC08	ISG 11	ORG
Nitto Kohki											20/30/40
Amflo								C20B	C26	C10	
Bosch					7.2						
Parker						55		30 / B23	25F	17	
Foster								3003	4404	5205	
Abnox					x						
Afnor NF 49053								x	x	x	
Camozzi					508/5180						
Dynaquip								1/4"	3/8"		
EWO					x						
Festo					KD						
Gromelle								600	900		
Hansen								22/3000	400/4000	500/5000	
Ingersoll Rand					7S7			A2/MS/102	A3/103/203	A4/104/204	
Kaeser					x						
Legris					25/26	27		23/24	30		13
Tomco								180	4000	5000	

Quick Couplings

Selection guide

MAXIMIZE YOUR PRODUCTIVITY!

Select full flow couplings from Atlas Copco

- Recommended by Atlas Copco for your application and tool.



ErgoQIC 08US	ErgoQIC 08 ErgoQIC 10AC	ErgoQIC 10 A	ErgoQIC 08E	ErgoQIC 10US	ErgoQIC 10	ErgoQIC 15E	ErgoQIC 15US
Air flow capacity 0-11 l/s	Air flow capacity 0-18 l/s	Air flow capacity 0-22 l/s	Air flow capacity 0-24 l/s	Air flow capacity 0-27 l/s	Air flow capacity 0-40 l/s	Air flow capacity 0-49 l/s	Air flow capacity 0-52 l/s

		Air flow requirements	ErgoQIC 08US	ErgoQIC 08 ErgoQIC 10AC	ErgoQIC 10 A	ErgoQIC 08E	ErgoQIC 10US	ErgoQIC 10	ErgoQIC 15E	ErgoQIC 15US
	Screwdrivers	Bolt size								
		M2-M6	2-8 l/s	•	•	•	•			
		Bolt size								
	Impact wrenches	Bolt size								
		1/4" HEX and 3/8"	2-9 l/s	•	•	•	•			
		3/8" and 1/2"	10-20 l/s			•	•			
	1" and 1 1/2"	28-37 l/s					•	•	•	
	Pulse tools	Bolt size								
		M4-M5	9 l/s	•	•	•	•			
		M6-M12	15-25 l/s		•	•	•	•	•	•
	M14-M20	32-49 l/s					•	•	•	
	Drills	Power								
		<820 W	8-21 l/s	•	•	•	•			
	Chipping hammers	Size								
		<7 kg	6.5-14 l/s	•	•	•	•			
	Die grinders	Power								
		<500 W	3-10 l/s	•	•	•	•			
		500-900 W	7-19 l/s			•	•	•		
	0.9-2 kW	20-35 l/s			•	•	•	•	•	
	Turbine grinders	Power								
	<2.5 kW	32 l/s					•	•	•	
	Blow guns		4-7.5 l/s	•	•	•	•			

ErgoQIC

The ErgoQIC coupling is a ball valve coupling with a safety feature offering a higher flow than ordinary coupling systems. The ErgoQIC is a strong and durable full flow quick coupling with no air restriction inside the coupling. It is suitable for assembly tools, drills and grinders. Upgrading any air system with ErgoQIC will give the benefits of productivity and energy efficiency. ErgoQIC is designed to minimize the risk of sudden component separation and sound bang. The safety features are according to EN 983 and ISO 4414. It is made of hardened steel.

The ErgoQIC disconnects in two steps; first you push in and bend slowly – the pressurized air hose will then vent, and as a second step you can disconnect without risk of harming the operator.



SmartQIC

SMARTQIC is the latest generation of pneumatic safety couplings and nipples. The couplings offers high flow and low pressure drop with innovative safety features. The design has a unique safety venting feature when disconnecting, thus minimizing risk of injury to the operator.

Durable and tough, the couplings are made out of zinc-plated steel/brass material and the entire product range complies with safety standards ISO 4414 and EN 983. SMARTQIC couplings also complies with OSHA 1910.95. Suitable for many types of applications and pneumatic tools; such as screwdrivers, assembly tools, drills and grinders.



Claw

CLAW couplings are made from dropforged, hardened steel which can withstand rough treatment and ensures a long life even under difficult conditions. The coupling head is the same for all hose sizes, which can therefore be freely combined. The recommended maximum working pressure is 10 bar.



MultiFlex Swivel

MultiFlex Swivel is a multi-directional connector. Once the tool is connected the hose will stay in the ideal position however much the operator and the tool move around. The MultiFlex bends and rotates 360° in all directions while the hose stays straight.



Quick Couplings

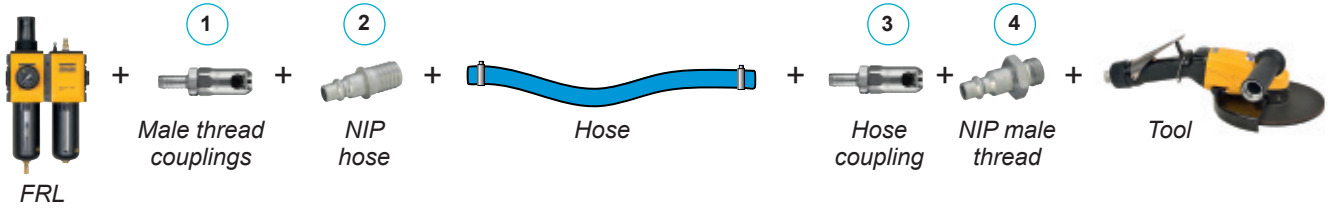

Atlas Copco Global standard

HOWTO...



NOTE: Most Atlas Copco tools come with a female thread, please check the thread before choosing your coupling and nip selection. Same selection process can be used for all couplings e.g. SmartQic ; ErgoQic, etc.

EXAMPLE

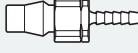
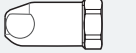
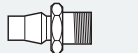
Connection type	Coupling ErgoQIC 10	Ordering No.	Size		Connection type	Nipple ErgoNIP 10	Ordering No.	Size	
			mm	in				mm	in
 H – Hose	H06	8202 1120 30	6.3	1/4	 H – Hose	H06	8202 1220 35	6.3	1/4
	H08	8202 1120 40	8	5/16		H08	8202 1220 43	8	5/16
	H10	8202 1120 02	10	3/8		H10	8202 1220 50	10	3/8
	H13	8202 1120 10	12.5	1/2		H13	8202 1220 68	12.5	1/2
	H16	8202 1120 50	16	5/8		H16	8202 1220 76	16	5/8
	H20	8202 1120 60	19	3/4		H20	8202 1220 77	19	3/4
 M – Male	M08	8202 1120 85	1/4	BSP	 SH – Safety Hose ^a	SH06	8202 1220 37	6.3	1/4
	M10	8202 1120 93	3/8	BSP		SH08	8202 1220 45	8	5/16
	M15	8202 1120 97	1/2	BSP		SH10	8202 1220 52	10	3/8
	M20	8202 1120 98	3/4	BSP		SH13	8202 1220 70	12.5	1/2
	M25	8202 1120 99	1	BSP		SH16	8202 1220 74	16	5/8
 F – Female	F08	8202 1121 00	1/4	BSP	 M – Male	M08	8202 1220 01	1/4	BSP
	F10	8202 1121 05	3/8	BSP		M10	8202 1220 19	3/8	BSP
	F15	8202 1121 10	1/2	BSP		M15	8202 1220 27	1/2	BSP



ErgoQIC 08

ATLAS COPCO GLOBAL STANDARD

The ErgoQIC 08 is a full flow quick coupling with no air restriction inside the coupling. It is suitable for assembly tools, drills and small grinders. Upgrading any air system with ErgoQIC 08 will give the benefits of productivity and energy efficiency.

- Full flow coupling.
- Ergonomic design, small size and low weight.
- Strong and durable.
- Safety feature according to EN 983 / ISO 4414.
- Protective rubber cover available.
- Main market: Global.

Technical Data

Max flow capacity	29 l/s (0.5 bar ΔP)
Economical air flow	18 l/s (0.2 bar ΔP)
Max working pressure	16 bar
Temperature range	-10°C to +70°C

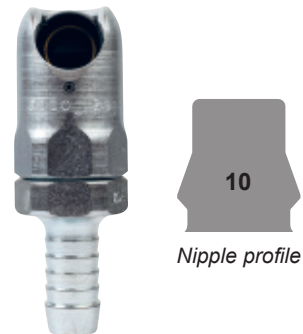

ErgoQIC 10

ATLAS COPCO GLOBAL STANDARD





The ErgoQIC 10 is a full flow coupling with no air restriction inside the coupling. It is suitable for assembly tools, drills and grinders. Upgrading any air system with ErgoQIC 10 will give the benefits of productivity and energy efficiency.

- Extreme full flow coupling.
- Strong and durable.
- Minimized connection force.
- Safety feature according to EN 983 / ISO 4414.
- Protective rubber cover available.
- Main market: Global.

Technical Data

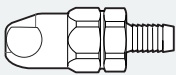
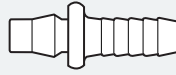

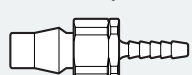
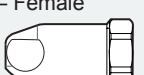

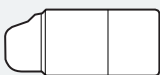
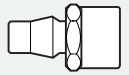
Max flow capacity	60 l/s (0.5 bar ΔP)
Economical air flow	40 l/s (0.2 bar ΔP)
Max working pressure	16 bar
Temperature range	-10°C to +70°C

ERGOQIC 08 AND ERGONIP 08, 18 L/S (recommended air flow at 6.3 bar pressure)

Connection type	Coupling ErgoQIC 08	Ordering No.	Size		Connection type	Nipple ErgoNIP 08	Ordering No.	Size	
			mm	in				mm	in
H – Hose 	H06	8202 1110 04	6.3	1/4	H – Hose 	H05	8202 1210 33	5	3/16
	H08	8202 1110 12	8	5/16		H06	8202 1210 37	6.3	1/4
	H10	8202 1110 38	10	3/8		H08	8202 1210 45	8	5/16
	H13	8202 1110 40	12.5	1/2		H10	8202 1210 52	10	3/8
M – Male 	M08	8202 1110 61	1/4	BSP	SH – Safety Hose^a 	SH06	8202 1210 39	6.3	1/4
	M10	8202 1110 79	3/8	BSP		SH08	8202 1210 47	8	5/16
	M15	8202 1110 87	1/2	BSP		SH10	8202 1210 50	10	3/8
F – Female 	F08	8202 1110 90	1/4	BSP		M – Male 	M06	8202 1210 03	1/8
	F10	8202 1110 95	3/8	BSP	M08		8202 1210 11	1/4	BSP
Protective cover 		9090 1940 00			M10		8202 1210 29	3/8	BSP
					M15		8202 1210 31	1/2	BSP
					F – Female 	F08	8202 1210 60	1/4	BSP
						F10	8202 1210 62	3/8	BSP

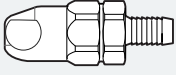
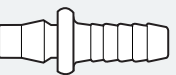
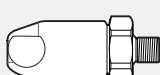
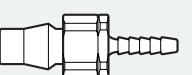
^a For joining hoses longer than 3 meters.

ERGOQIC 10 AND ERGONIP 10, 40 L/S (recommended air flow at 6.3 bar pressure)

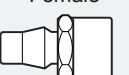
Connection type	Coupling ErgoQIC 10	Ordering No.	Size		Connection type	Nipple ErgoNIP 10	Ordering No.	Size	
			mm	in				mm	in
H – Hose 	H06	8202 1120 30	6.3	1/4	H – Hose 	H06	8202 1220 35	6.3	1/4
	H08	8202 1120 40	8	5/16		H08	8202 1220 43	8	5/16
	H10	8202 1120 02	10	3/8		H10	8202 1220 50	10	3/8
	H13	8202 1120 10	12.5	1/2		H13	8202 1220 68	12.5	1/2
	H16	8202 1120 50	16	5/8		H16	8202 1220 76	16	5/8
	H20	8202 1120 60	19	3/4		H20	8202 1220 77	19	3/4
M – Male 	M08	8202 1120 85	1/4	BSP	SH – Safety Hose^a 	SH06	8202 1220 37	6.3	1/4
	M10	8202 1120 93	3/8	BSP		SH08	8202 1220 45	8	5/16
	M15	8202 1120 97	1/2	BSP		SH10	8202 1220 52	10	3/8
	M20	8202 1120 98	3/4	BSP		SH13	8202 1220 70	12.5	1/2
	M25	8202 1120 99	1	BSP		SH16	8202 1220 74	16	5/8
F – Female 	F08	8202 1121 00	1/4	BSP	M – Male 	M08	8202 1220 01	1/4	BSP
	F10	8202 1121 05	3/8	BSP		M10	8202 1220 19	3/8	BSP
	F15	8202 1121 10	1/2	BSP		M15	8202 1220 27	1/2	BSP
Protective cover 		9090 1931 00			F – Female 	F08	8202 1220 84	1/4	BSP
						F10	8202 1220 86	3/8	BSP
						F15	8202 1220 88	1/2	BSP

^a For joining hoses longer than 3 meters.

Quick Couplings

Euro standard 7.6 (7.4)



Nipple profile



Nipple profile

ErgoQIC 08E

EURO STANDARD 7.6 (7.4)

The ErgoQIC 08E is a full flow quick coupling with no air restriction inside the coupling. It is suitable for assembly tools, drills and small grinders. Upgrading any air system using Eurostandard nipples with ErgoQIC 08E couplings will give the benefits of productivity and energy efficiency.

- Full flow coupling.
- Ergonomic design, small size and low weight.
- Strong and durable.
- Safety feature according to EN 983 / ISO 4414.
- Protective rubber cover available.
- Main market: Europe.

Technical Data

Max flow capacity	38 l/s (0.5 bar ΔP)
Economical air flow	24 l/s (0.2 bar ΔP)
Max working pressure	16 bar
Temperature range	-10°C to +70°C

Atlas Copco SmartQIC 08E

EURO STANDARD 7.6 (7.4)

Safety coupling with venting connection, high flow and low pressure drop.

Common standard used in EU-markets for many types of assembly and material removal tools.

- High reliability with low pressure drop.
- Safety function with vented connection.
- High durability and easy handling.
- High air flow and increased productivity.
- Minimizes hose whip and injuries to operator.
- Long life time.
- Safety feature according to ISO-standard 4414 and EN 983.
- Complies with OSHA 1910.95.
- Main market: Europe.



Technical Data

Max flow capacity	38 l/s (0.5 bar ΔP)
Economical air flow	35 l/s (0.2 bar ΔP)
Max working pressure	16 bar
Temperature range	-20°C to +100°C

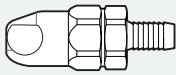
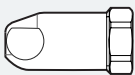
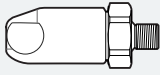
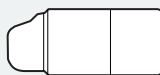
ERGOQIC 08E, 24 L/S (recommended air flow at 6.3 bar pressure)

Connection type	Coupling ErgoQIC 08E	Ordering No.	Size		Connection type	Coupling ErgoQIC 08E	Ordering No.	Size	
			mm	in				mm	in
H – Hose 	H06	8202 1106 00	6.3	1/4	F – Female 	F08	8202 1106 07	1/4 BSP	
	H08	8202 1106 01	8	5/16		F10	8202 1106 08	3/8 BSP	
	H10	8202 1106 02	10	3/8		F15	8202 1106 09	1/2 BSP	
	H13	8202 1106 03	12.5	1/2					
M – Male thread 	M08	8202 1106 04	1/4 BSP		Protective cover 		9090 1940 01		
	M10	8202 1106 05	3/8 BSP						
	M15	8202 1106 06	1/2 BSP						

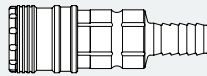
SMARTQIC 08E, 35 L/S (recommended air flow at 6.3 bar pressure)

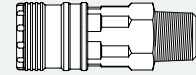
Connection type	Coupling SmartQIC-08E	Ordering No.	Size		Connection type	Coupling SmartQIC-08E	Ordering No.	Size	
			mm	in				mm	in
H – Hose 	H08	4221 0010 00	8	1/4	F – Female 	F06	4221 0010 06	1/4 BSP	
	H10	4221 0010 01	10	5/16		F10	4221 0010 07	3/8 BSP	
	H13	4221 0010 02	13	3/8		F15	4221 0010 08	1/2 BSP	
M – Male 	M06	4221 0010 03*	1/4 BSPT						
	M10	4221 0010 04*	3/8 BSPT						
	M15	4221 0010 05*	1/2 BSPT						

NIP 08E, 35 L/S (recommended air flow at 6.3 bar pressure) *FOR ERGOQIC 08E AND SMARTQIC 08E*

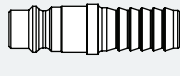
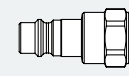
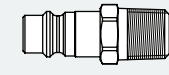
Connection type	Nipple NIP-08E	Ordering No.	Size		Connection type	Nipple NIP-08E	Ordering No.	Size	
			mm	in				mm	in
H – Hose 	H06	4221 0011 00	6.3	1/4	F – Female 	F06	4221 0011 07	1/4 BSP	
	H08	4221 0011 01	8	5/16		F10	4221 0011 08	3/8 BSP	
	H10	4221 0011 02	10	3/8		F15	4221 0011 09	1/2 BSP	
	H13	4221 0011 03	13	5/16					
M – Male 	M04	4221 0002 81*	1/8 BSPT						
	M06	4221 0011 04	1/4 BSP						
	M10	4221 0011 05	3/8 BSP						
	M15	4221 0011 06	1/2 BSP						

* Preapplied sealent.

Quick Couplings

Euro standard 10.4 and 15 mm



Nipple profile



Nipple profile

ErgoQIC 15E

EURO STANDARD 10.4

The ErgoQIC 15E is a full flow coupling with no air restriction inside the coupling suitable for large air consuming assembly tools, drills and grinders. Upgrading any air system with ErgoQIC 15E will give the benefit of productivity and energy efficiency.

- Extreme full flow coupling.
- Strong and durable.
- Minimized connection force.
- Safety feature according to EN 983 / ISO 4414.
- Main market: Europe.

Technical Data

Max flow capacity	76 l/s (0.5 bar ΔP)
Economical air flow	49 l/s (0.2 bar ΔP)
Max working pressure	16 bar
Temperature range	-20°C to +80°C

Atlas Copco SmartQIC 15E

EURO STANDARD 10.4

Safety coupling with venting connection, high flow and low pressure drop. Common standard used in EU-markets for many types of assembly and material removal tools.

- High reliability with low pressure drop.
- Safety function with vented connection.
- High durability and easy handling.
- High air flow and increased productivity.
- Minimizes hose whip and injuries to operator.
- Long life time.
- Safety feature according to ISO-standard 4414 and EN 983.
- Complies with OSHA 1910.95.
- Main market: Europe.

Technical Data

Max flow capacity	68 l/s (0.5 bar ΔP)
Economical air flow	63 l/s (0.2 bar ΔP)
Max working pressure	16 bar
Temperature range	-20°C to +100°C

ERGOQIC 15E, 49 L/S (recommended air flow at 6.3 bar pressure)

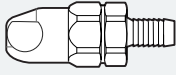
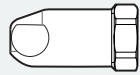
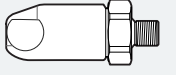
Connection type	Coupling ErgoQIC 15E	Ordering No.	Size		Connection type	Coupling ErgoQIC 15E	Ordering No.	Size	
			mm	in				mm	in
H – Hose 	H10	8202 1106 50	10	3/8	F – Female 	F10	8202 1106 70	3/8 BSP	
	H13	8202 1106 51	12.5	1/2		F15	8202 1106 71	1/2 BSP	
	H16	8202 1106 52	10	3/8					
	H20	8202 1106 53	12.5	1/2					
M – Male thread 	M10	8202 1106 60	3/8 BSP						
	M15	8202 1106 61	1/2 BSP						
	M20	8202 1106 62	3/4 BSP						
	M25	8202 1106 63	1 BSP						

SMARTQIC 15E, 63 L/S (recommended air flow at 6.3 bar pressure)

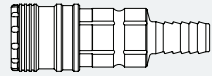
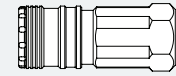
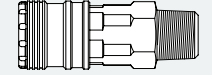
Connection type	Coupling SmartQIC 15E	Ordering No.	Size		Connection type	Coupling SmartQIC 15E	Ordering No.	Size	
			mm	in				mm	in
H – Hose 	H10	4221 0020 00	10	3/8	F – Female 	F10	4221 0020 07	3/8 BSP	
	H13	4221 0020 01	13	1/2		F15	4221 0020 08	1/2 BSP	
	H16	4221 0020 02	16	5/8		F20	4221 0020 09	3/4 BSP	
	H20	4221 0020 03	19	3/4					
M – Male 	M10	4221 0020 04	3/8 BSPT						
	M15	4221 0020 05	1/2 BSPT						
	M20	4221 0020 06	3/4 BSPT						

NIP-15E, EU 10.4, 63 L/S (recommended air flow at 6.3 bar pressure) FOR ERGOQIC 15E AND SMARTQIC 15E

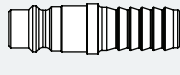
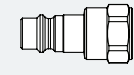
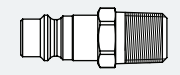
Connection type	Nipple NIP 15E	Ordering No.	Size		Connection type	Nipple NIP 15E	Ordering No.	Size	
			mm	in				mm	in
H – Hose 	H10	4221 0021 00	10	3/8	F – Female 	F10	4221 0021 07	3/8 BSP	
	H13	4221 0021 01	13	1/2		F15	4221 0021 08	1/2 BSP	
	H16	4221 0021 02	16	5/8		F20	4221 0021 09	3/4 BSP	
	H20	4221 0021 03	19	3/4					
M – Male thread 	M10	4221 0021 04	3/8 BSPT						
	M15	4221 0021 05	1/2 BSPT						
	M20	4221 0021 06	1/2 BSPT						

NOTE: T at the end stands for tapered thread e.g. BSPT.

Quick Couplings

ISO 6150-B / US Standard 5.3 mm (1/4")



Nipple profile



Nipple profile

ErgoQIC 08US

ISO 6150-B / US STANDARD

The ErgoQIC 08US is a full flow quick coupling with no air restriction inside the coupling suitable for assembly tools, drills and small grinders. Upgrading any air system with ErgoQIC 08US will give the benefit of productivity and energy efficiency.

- Full flow coupling.
- Ergonomic design, small size and low weight.
- Strong and durable.
- Safety feature according to EN 983 / ISO 4414.
- Main market: North America, France, Norway and Spain.

Technical Data

Max flow capacity	17 l/s (0.5 bar ΔP)
Economical air flow	11 l/s (0.2 bar ΔP)
Max working pressure	16 bar
Temperature range	-20°C to +80°C

Atlas Copco SmartQIC 08US

ISO 6150-B / US STANDARD

Safety coupling with venting connection, high flow and low pressure drop.

- High reliability with low pressure drop.
- Safety function with vented connection.
- High durability and easy handling.
- High air flow and increased productivity.
- Minimizes hose whip and injuries to operator.
- Long life time.
- Safety feature according to ISO-standard 4414 and EN 983.
- Main market: Benelux, France, Norway and North America.



Technical Data

Max flow capacity	16 l/s (0.5 bar ΔP)
Economical air flow	15 l/s (0.2 bar ΔP)
Max working pressure	16 bar
Temperature range	-20°C to +100°C

Quick Couplings

ISO 6150-B / US Standard 5.3 mm (1/4")

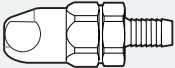
ERGOQIC 08US, 11 L/S (recommended air flow at 6.3 bar pressure)

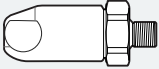
Connection type	Coupling ErgoQIC 08US	Ordering No.	Size		Connection type	Coupling ErgoQIC 08US	Ordering No.	Size	
			mm	in				mm	in
H – Hose 	H06	8202 1103 00	6.3	1/4	F – Female 	F08	8202 1103 11	1/4	BSP
	H08	8202 1103 01	8	5/16		F10	8202 1103 13	3/8	BSP
	H10	8202 1103 02	10	3/8					
M – Male thread 	M08	8202 1103 05		1/4	BSP				
	M10	8202 1103 07		3/8	BSP				
	M15	8202 1103 09		1/2	BSP				

SMARTQIC 08US, 15 L/S (recommended air flow at 6.3 bar pressure)

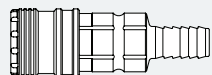
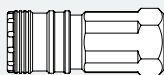
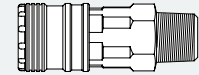
Connection type	Coupling SmartQIC 08US	Ordering No.	Size		Connection type	Coupling SmartQIC 08US	Ordering No.	Size	
			mm	in				mm	in
H – Hose 	H06	4221 0030 00	6.3	1/4	F – Female 	F08	4221 0030 07	1/4	BSP
	H08	4221 0030 01	8	5/16		F10	4221 0030 08	3/8	BSP
	H10	4221 0030 02	10	3/8		F08	4221 0030 09	1/4	NPT
M – Male 	M08	4221 0030 03		3/8	BSPT	F10	4221 0030 10	3/8	NPT
	M10	4221 0030 04		1/2	BSPT				
	M08	4221 0030 05		3/8	NPT				
	M10	4221 0030 06		1/2	NPT				

NIP 08US, 11 L/S (recommended air flow at 6.3 bar pressure) FOR ERGOQIC 08US AND SMARTQIC 08US

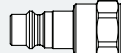
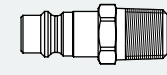
Connection type	Nipple NIP 08US	Ordering No.	Size		Connection type	Nipple NIP 08US	Ordering No.	Size	
			mm	in				mm	in
H – Hose 	H06	4221 0031 00	6.3	1/4	F – Female 	F06	4221 0031 07	1/4	BSP
	H08	4221 0031 01	8	5/16		F10	4221 0031 08	3/8	BSP
	H10	4221 0031 02	10	3/8		F06	4221 0031 09	1/4	NPT
M – Male thread 	M04	4221 0002 82*		1/8	BSPT	F10	4221 0031 10	3/8	NPT
	M08	4221 0031 03*		1/4	BSPT				
	M10	4221 0031 04*		3/8	BSPT				
	M08	4221 0031 05*		1/4	NPT				
	M10	4221 0031 06*		3/8	NPT				

* Preapplied sealent.

NOTE: T at the end stands for tapered thread e.g. BSPT.

Quick Couplings

ISO 6150-B / US Standard 8.2 mm (3/8")

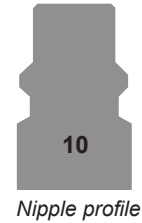
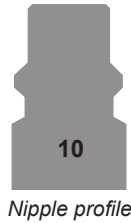

ErgoQIC 10US

ISO 6150-B / US STANDARD

The ErgoQIC 10US is a full flow quick coupling with no air restriction inside the coupling suitable for assembly tools, drills and small grinders. Upgrading any air system with ErgoQIC 10US couplings will give the benefit of productivity and energy efficiency. It is interchangeable with US 3/8" standard nipples.

- Full flow coupling.
- Ergonomic design, small size and low weight.
- Strong and durable.
- Safety feature according to EN 983 / ISO 4414.
- Main market: North America, France, Norway and Spain.

Technical Data

Max flow capacity	43 l/s (0.5 bar ΔP)
Economical air flow	27 l/s (0.2 bar ΔP)
Max working pressure	16 bar
Temperature range	-20°C to +80°C

Atlas Copco SmartQIC 10US

ISO 6150-B / US STANDARD

Safety coupling with venting connection, high flow and low pressure drop.

- High reliability with low pressure drop.
- Safety function with vented connection.
- High durability and easy handling.
- High air flow and increased productivity.
- Minimizes hose whip and injuries to operator.
- Long life time.
- Safety feature according to ISO-standard 4414 and EN 983.
- Main market: Benelux, France, Norway and North America.

Technical Data

Max flow capacity	43 l/s (0.5 bar ΔP)
Economical air flow	39 l/s (0.2 bar ΔP)
Max working pressure	16 bar
Temperature range	-20°C to +100°C



Quick Couplings

ISO 6150-B / US Standard 8.2 mm (3/8")

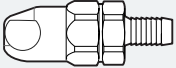
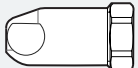
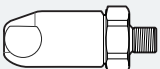

ERGOQIC 10US, 27 L/S (recommended air flow at 6.3 bar pressure)

Connection type	Coupling ErgoQIC 10US	Ordering No.	Size		Connection type	Coupling ErgoQIC 10US	Ordering No.	Size	
			mm	in				mm	in
 H – Hose	H08	8202 1107 01	8	5/6	 F – Female	F08	8202 1107 13	1/4	BSP
	H10	8202 1107 02	10	3/8		F10	8202 1107 15	3/8	BSP
	H13	8202 1107 03	12.5	1/2		F15	8202 1107 17	1/2	BSP
	H20	8202 1107 05	19	3/4					
 M – Male thread	M08	8202 1107 07	1/4	BSP					
	M10	8202 1107 09	3/8	BSP					
	M15	8202 1107 11	1/2	BSP					

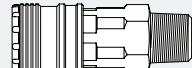
SMARTQIC 10US, 39 L/S (recommended air flow at 6.3 bar pressure)

Connection type	Coupling SmartQIC 10US	Ordering No.	Size		Connection type	Coupling SmartQIC 10US	Ordering No.	Size	
			mm	in				mm	in
 H – Hose	H10	4221 0050 00	10	3/2	 F – Female	F10	4221 0050 06	3/8	BSP
	H13	4221 0050 01	13	1/2		F15	4221 0050 07	1/2	BSP
 M – Male	M10	4221 0050 02	3/8	BSPT		F10	4221 0050 08	3/8	NPT
	M15	4221 0050 03	1/2	BSPT		F15	4221 0050 09	1/2	NPT
	M10	4221 0050 04	3/8	NPT					
	M15	4221 0050 05	1/2	NPT					

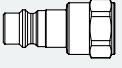
NIP-10US, 39 L/S (recommended air flow at 6.3 bar pressure) FOR ERGOQIC 10US AND SMARTQIC 10US

Connection type	Nipple NIP 10US	Ordering No.	Size		Connection type	Nipple NIP 10US	Ordering No.	Size	
			mm	in				mm	in
 H – Hose	H08	4221 0051 00	8	5/16	 F – Female	F06	4221 0051 09	1/4	BSP
	H10	4221 0051 01	10	3/8		F10	4221 0051 10	3/8	BSP
	H13	4221 0051 02	13	1/2		F15	4221 0051 11	1/2	BSP
 M – Male thread	M06	4221 0051 03	1/4	BSPT		F06	4221 0051 12	1/4	NPT
	M10	4221 0051 04	3/8	BSPT	F10	4221 0051 13	3/8	NPT	
	M15	4221 0051 05	1/2	BSP	F15	4221 0051 14	1/2	NPT	
	M06	4221 0051 06	1/4	NPT					
	M10	4221 0051 07	3/8	NPT					
M15	4221 0051 08	1/2	NPT						

NOTE: T at the end stands for tapered thread e.g. BSPT.

Quick Couplings

ISO 6150-B / US standard 11 mm (1/2")

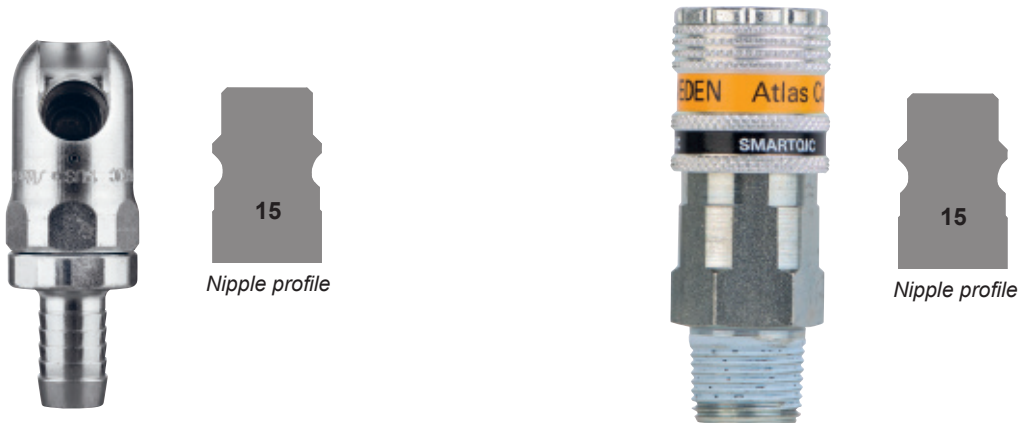

ErgoQIC 15US

ISO 6150-B / US STANDARD

The ErgoQIC 15US is a full flow coupling with no air restriction inside the coupling suitable for large air consuming assembly tools, drills and grinders. Upgrading any air system with ErgoQIC 15US will give the benefit of productivity and energy efficiency. It is interchangeable with US 1/2" standard nipples.

- Extreme full flow coupling.
- Strong and durable.
- Minimized connection force.
- Safety feature according to EN 983 / ISO 4414.
- Main market: North America, France, Norway and Spain.

Technical Data

Max flow capacity	77 l/s (0.5 bar ΔP)
Economical air flow	52 l/s (0.2 bar ΔP)
Max working pressure	16 bar
Temperature range	-20°C to +80°C

Atlas Copco SmartQIC 15US

ISO 6150-B / US STANDARD

Safety coupling with venting connection, high flow and low pressure drop.

- High reliability with low pressure drop.
- Safety function with vented connection.
- High durability and easy handling.
- High air flow and increased productivity.
- Minimizes hose whip and injuries to operator.
- Long life time.
- Safety feature according to ISO-standard 4414 and EN 983.
- Main market: North America, France, Norway and Spain.

Technical Data

Max flow capacity	69 l/s (0.5 bar ΔP)
Economical air flow	64 l/s (0.2 bar ΔP)
Max working pressure	16 bar
Temperature range	-20°C to +100°C

Quick Couplings

ISO 6150-B / US standard 11 mm (1/2")

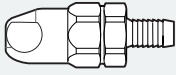
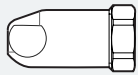
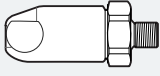

ERGOQIC 15US, 52 L/S (recommended air flow at 6.3 bar pressure)

Connection type	Coupling ErgoQIC 15US	Ordering No.	Size		Connection type	Coupling ErgoQIC 15US	Ordering No.	Size	
			mm	in				mm	in
H – Hose 	H10	8202 1108 02	10	3/8	F – Female 	F10	8202 1108 15	3/8	BSP
	H13	8202 1108 03	12.5	1/2		F15	8202 1108 17	1/2	BSP
	H16	8202 1108 04	16	5/8					
	H20	8202 1108 05	19	3/4					
M – Male thread 	M10	8202 1108 09	3/8 BSP						
	M15	8202 1108 11	1/2 BSP						

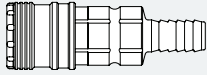
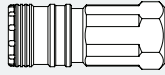
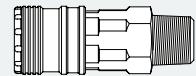
SMARTQIC 15US, 8 L/S (recommended air flow at 6.3 bar pressure)

Connection type	Coupling SmartQIC 15US	Ordering No.	Size		Connection type	Coupling SmartQIC 15US	Ordering No.	Size	
			mm	in				mm	in
H – Hose 	H13	4221 0040 00	13	1/2	F – Female 	F10	4221 0040 06	3/8	NPT
	H20	4221 0040 02	19	3/4		F15	4221 0040 07	1/2	NPT
						F20	4221 0040 08	3/4	NPT
M – Male 	M10	4221 0040 03	3/8 NPT						
	M15	4221 0040 04	1/2 NPT						
	M20	4221 0040 05	3/4 NPT						

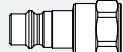
NIP 15US, 52 L/S (recommended air flow at 6.3 bar pressure) FOR ERGOQIC 15US AND SMARTQIC 15US

Connection type	Nipple NIP 15US	Ordering No.	Size		Connection type	Nipple NIP 15US	Ordering No.	Size	
			mm	in				mm	in
H – Hose 	H10	4221 0041 00	10	3/8	F – Female 	F10	4221 0041 07	3/8	NPT
	H13	4221 0041 01	13	1/2		F15	4221 0041 08	1/2	NPT
	H20	4221 0041 03	19	3/4		F20	4221 0041 09	3/4	NPT
M – Male thread 	M10	4221 0041 04	3/8 NPT						
	M15	4221 0041 05	1/2 NPT						
	M20	4221 0041 06	3/4 NPT						

Quick Couplings

Atlas Copco Global standard

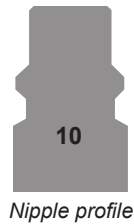

ErgoQIC 10AC

ATLAS COPCO GLOBAL STANDARD

The ErgoQIC 10AC is a full flow quick coupling with no air restriction inside the coupling suitable for assembly tools, drills and small grinders. Upgrading any air system with ErgoQIC 10AC will give the benefit of productivity and energy efficiency.

- Full flow coupling.
- Ergonomic design, small size and low weight.
- Strong and durable.
- Safety feature according to EN 983 / ISO 4414.
- Main market: Nordic, Benelux and Italy.

Technical Data

Max flow capacity	26 l/s (0.5 bar ΔP)
Economical air flow	17 l/s (0.2 bar ΔP)
Max working pressure	16 bar
Temperature range	-10°C to +70°C

EURO STANDARD 15 MM

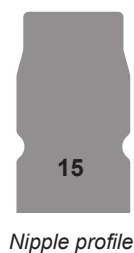

QIC 10

ATLAS COPCO GLOBAL STANDARD

The QIC 10 is a small quick coupling suitable for assembly tools and drills. The QIC 10 can withstand extremely rough handling in tough applications.

- High flow coupling.
- Strong and durable.
- One-hand operation.
- Main market: Europe and Australia.

Technical Data

Max flow capacity	24 l/s (0.5 bar ΔP)
Economical air flow	15 l/s (0.2 bar ΔP)
Max working pressure	16 bar
Temperature range	-20°C to +80°C

QIC 15

EURO STANDARD 15 MM



The QIC 15 quick coupling is suitable for assembly tools, grinders and drills. The QIC 15 can withstand extremely rough handling in tough applications.

- Extremely high flow.
- Strong and durable.
- One-hand operation.
- Main market: Europe.

Technical Data

Max flow capacity	48 l/s (0.5 bar ΔP)
Economical air flow	30 l/s (0.2 bar ΔP)
Max working pressure	16 bar
Temperature range	-20°C to +80°C

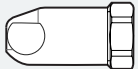
ERGOQIC 10AC, 17 L/S (recommended air flow at 6.3 bar pressure)

Connection type	Coupling ErgoQIC 10AC	Ordering No.	Size		Connection type	Coupling ErgoQIC 10AC	Ordering No.	Size	
			mm	in				mm	in
 H – Hose	H08	8202 1109 01	8	5/16	 F – Female	F08	8202 1109 09	1/4	BSP
	H10	8202 1109 02	10	3/8		F10	8202 1109 10	3/8	BSP
	H13	8202 1109 03	12.5	1/2		F15	8202 1109 11	1/2	BSP
 M – Male thread	M08	8202 1109 05	1/4	BSP					
	M10	8202 1109 06	3/8	BSP					
	M15	8202 1109 07	1/2	BSP					

QIC 10, 15 L/S (recommended air flow at 6.3 bar pressure)

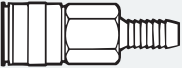
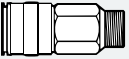
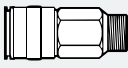
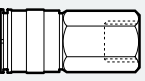
Connection type	Coupling QIC 10	Ordering No.	Size		Connection type	Coupling QIC 10	Ordering No.	Size	
			mm	in				mm	in
 H – Hose	H06	8202 1302 02	6.3	1/4	 MT – Male taper thread	MT15	8202 1302 51	1/2	BSPT
	H08	8202 1302 10	8	5/16					
	H10	8202 1302 28	10	3/8					
	H13	8202 1302 34	12.5	1/2					
 M – Male thread	M08	8202 1302 36	1/4	BSP	 F – Female	F08	8202 1302 69	1/4	BSP
	M10	8202 1302 44	3/8	BSP					





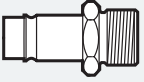
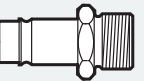
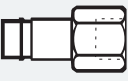

^a For hoses longer than 3 meters.

NIP 10, 17 L/S (recommended air flow at 6.3 bar pressure) FOR ERGOQIC 10AC AND QIC 10

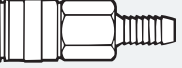
Connection type	Nipple NIP 10	Ordering No.	Size		Connection type	Nipple NIP 10	Ordering No.	Size	
			mm	in				mm	in
 H – Hose	H06	8202 1202 11	6.3	3/8	 MT – Male taper thread	MT08	8202 1202 60	1/4	BSPT
	H08	8202 1202 94	8	1/2		MT10	8202 1202 78	3/8	BSPT
	H10	8202 1202 29	10	5/8		MT15	8202 1203 02	1/2	BSPT
	H13	8202 1202 34	12.5	3/4					
 M – Male thread	M06	8202 1202 37	1/8	BSP	 F – Female	F08	8202 1202 86	1/4	BSP
	M08	8202 1202 45	1/4	BSP		F10	8202 1202 87	3/8	BSP
	M10	8202 1202 52	3/8	BSP					

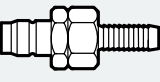
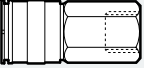
15 mm

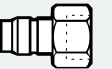
QIC 15 AND NIP 15, 30 L/S (recommended air flow at 6.3 bar pressure)

Connection type	Coupling QIC 15	Ordering No.	Size		Connection type	Nipple NIP 15	Ordering No.	Size	
			mm	in				mm	in
 H – Hose	H10	8202 1304 00	10	3/8	 H – Hose	H06	8202 1251 03	6.3	1/4
	H13	8202 1304 18	12.5	1/2		H08	8202 1252 28	8	5/16
	H16	8202 1304 26	16	5/8		H10	8202 1251 11	10	3/8
						H13	8202 1251 29	12.5	1/2
 M – Male thread	M08	8202 1304 34	1/4	BSP	 SH – Safety Hose ^a	SH10	8202 1203 44	10	3/8
	M10	8202 1304 42	3/8	BSP		SH13	8202 1203 51	12.5	1/2
	M15	8202 1304 59	1/2	BSP		SH16	8202 1203 69	16	5/8
 F – Female thread	F15	8202 1304 67	1/2	BSP	 M – Male thread /	M10	8202 1251 45	3/8	BSP
						M15	8202 1251 52	1/2	BSP
 F – Female thread	F08	8202 1251 94	1/4	BSP	 MT – Male taper thread	MT08	8202 1251 60	1/4	BSPT
	F10	8202 1252 02	3/8	BSP		MT10	8202 1251 78	3/8	BSPT
	F15	8202 1252 10	1/2	BSP		MT15	8202 1251 86	1/2	BSPT

^a For hoses longer than 3 meters.

Quick Couplings

ASIA Standard 7.5 mm

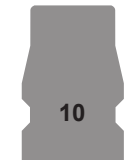

Nipple profile



Nipple profile

ErgoQIC 10A

ASIA STANDARD 7.5 MM

The ErgoQIC 10 ASIA is a full flow coupling with no air restriction inside the coupling. It is suitable for assembly tools, drills and grinders. Upgrading any air system with ErgoQIC 10 ASIA will give the benefits of productivity and energy efficiency.

- Extreme full flow coupling.
- Strong and durable.
- Minimized connection force.
- Safety feature according to EN 983 / ISO 4414.
- Main market: Asia, Australia, Italy and South America.

Technical Data

Max flow capacity	35 l/s (0.5 bar ΔP)
Economical air flow	22 l/s (0.2 bar ΔP)
Max working pressure	16 bar
Temperature range	-20°C to +70°C

Atlas Copco SmartQIC 10A

ASIA STANDARD 7.5 MM

Safety coupling with venting connection, high flow and low pressure drop.

- High reliability with low pressure drop.
- Safety function with vented connection.
- High durability and easy handling.
- High air flow and increased productivity.
- Minimizes hose whip and injuries to operator.
- Long life time.
- Safety feature according to ISO-standard 4414 and EN 983.
- Main market: Asia, Australia, Italy and South America.



Technical Data

Max flow capacity	33 l/s (0.5 bar ΔP)
Economical air flow	32 l/s (0.2 bar ΔP)
Max working pressure	16 bar
Temperature range	-20°C to +100°C

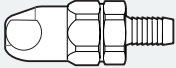
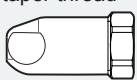
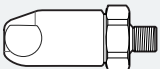

ERGOQIC 10A, 22 L/S (recommended air flow at 6.3 bar pressure)

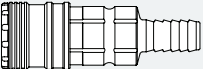
Connection type	Coupling ErgoQIC 10A	Ordering No.	Size		Connection type	Coupling ErgoQIC 10A	Ordering No.	Size	
			mm	in				mm	in
 H – Hose	H06	8202 1104 00	6.3	1/4	 FT – Female taper thread	FT08	8202 1104 09	1/4	BSPT
	H08	8202 1104 01	8	5/16		FT10	8202 1104 10	3/8	BSPT
	H10	8202 1104 02	10	3/8		FT15	8202 1104 11	1/2	BSPT
	H13	8202 1104 03	12.5	1/2					
 MT – Male taper thread	MT08	8202 1104 05		1/4 BSPT					
	MT10	8202 1104 06		3/8 BSPT					
	MT15	8202 1104 07		1/2 BSPT					

SMARTQIC 10A, 32 L/S (recommended air flow at 6.3 bar pressure)

Connection type	Coupling SmartQIC 10A	Ordering No.	Size		Connection type	Coupling SmartQIC 10A	Ordering No.	Size	
			mm	in				mm	in
 H – Hose	H06	4221 0060 00	6.3	1/4	 F – Female thread	F06	4221 0060 06	1/4	BSP
	H08	4221 0060 01	7	9/32		F10	4221 0060 07	3/8	BSP
	H10	4221 0060 02	10	3/8		F15	4221 0060 08	1/2	BSP
 M – Male thread	M06	4221 0060 03		1/4 BSP					
	M10	4221 0060 04		3/8 BSP					
	M15	4221 0060 05		1/2 BSP					

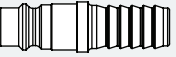
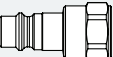
NIP 10A, 22 L/S (recommended air flow at 6.3 bar pressure) FOR ERGOQIC 10A AND SMARTQIC 10A

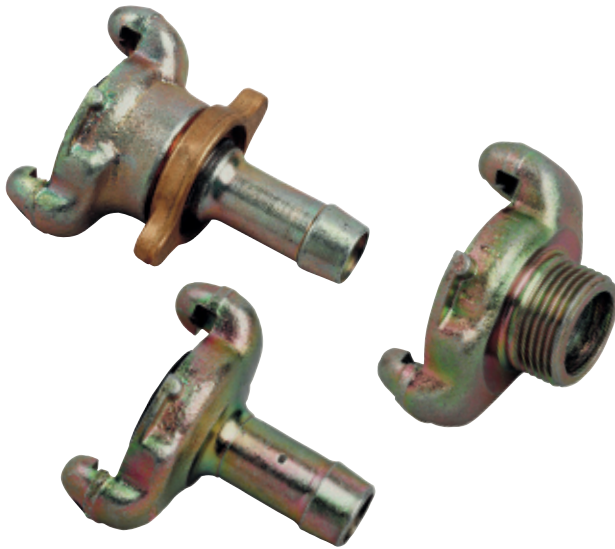

Connection type	Nipple NIP 10A	Ordering No.	Size		Connection type	Nipple NIP 10A	Ordering No.	Size	
			mm	in				mm	in
 H – Hose	H06	4221 0061 00	6.3	1/4	 F – Female	F06	4221 0061 07	1/4	BSPT
	H08	4221 0061 01	7	9/32		F10	4221 0061 08	3/8	BSPT
	H10	4221 0061 02	10	3/8		F15	4221 0061 09	1/2	BSPT
	H13	4221 0061 03	12.5	1/2					
 M – Male thread	M04	4221 0002 83		1/8 BSPT					
	M06	4221 0061 04		1/4 BSPT					
	M10	4221 0061 05		3/8 BSPT					
	M15	4221 0061 06		1/2 BSPT					

Claw Couplings

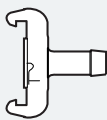
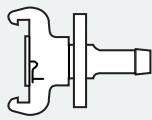
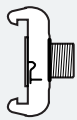
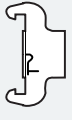

CLAW couplings are made from dropforged, hardened steel which can withstand rough treatment and ensures a long life even under difficult conditions. The coupling head is the same for all sizes, which can therefore be freely combined. The recommended maximum working pressure is 10 bar.

- Large bore – machined surfaces give low air resistance and minimum pressure drop.
- Robust claws – will withstand rough handling without deformation.
- Locking lugs – precision-made to provide a reliable lock.
- Special rubber packings – resistant to oil and temperature changes. Max. temperature 80°C (176°F).
- Packing seats – lathe-turned grooves ensure a leak-proof seal.
- Couplings are zinc-plated and thus effectively treated against corrosion.
- Available with extra protective cover.

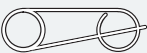
Connection type	Coupling CLAW	Ordering No.	Size		Bore B, mm
			mm	in	
H – Hose 	H06	9000 0308 00	6.3	1/4	5.0
	H10	9000 0309 00	10	3/8	8.0
	H13	9000 0310 00	12.5	1/2	10.5
	H16	9000 0311 00	16	5/8	13.5
	H20	9000 0312 00	19	3/4	17.0
	H25	9000 0313 00	25	1	22.0
LNH – Lock nut, Hose 	LNH10	9000 0260 00	10	3/8	8.0
	LNH13	9000 0261 00	12.5	1/2	10.5
	LNH16	9000 0262 00	16	5/8	13.5
	LNH20	9000 0263 00	19	3/4	17.2
	LNH25	9000 0264 00	25	1	22.0
M – Male thread 	M10	9000 0300 00		3/8 BSP	11.2
	M15	9000 0301 00		1/2 BSP	14.8
	M20	9000 0302 00		3/4 BSP	19.0
	M25	9000 0303 00		1 BSP	25.5
F – Female thread 	F10	9000 0304 00		3/8 BSP	15.0
	F15	9000 0305 00		1/2 BSP	18.6
	F20	9000 0306 00		3/4 BSP	24.0
	F25	9000 0307 00		1 BSP	25.0
Protection cover for CLAW couplings		9000 0314 00			
Extra packing for CLAW couplings		For type H, M and F	9000 0000 00 (+80°C), 9000 0000 01 (+200°C) ^a		
		For LNH10, -13 and -16	9000 0015 00		
		For LNH20 and -25	9000 0268 00 (+80°C), 9000 0319 00 (+200°C) ^a		
Safety lock spring		3176 8640 90	25 pieces		

^a Viton-green.

BAL



BAL1A

The Atlas Copco **valves BAL and BAL-1A** are both suitable for air, water and many other liquids and gases due to the choice of material.

- Silicone-free grease – Both are lubricated with silicone-free grease which is important when spray-painting.
- Maximum through flow – Full bore valve to DIN standards.
- Housing and ball made of chrome-plated hot-stamped brass MS 58.
- Handle of enamelled aluminum.

BAL – with nitrile rubber seals

BAL valves can be used in all settings between fully open and fully closed. The balls and the seals can be replaced without the body being removed from the piping.

BAL-1A – with teflon seals

Intended for operating either fully open or fully closed.

Model	Connection thread in BSP	Bore D mm	L mm	H mm	l mm	Ordering No.
BAL 08	1/4	9.5	50	41	-	8202 0301 05
BAL 10	3/8	9.5	50	41	-	8202 0302 04
BAL 15	1/2	12.5	60	43	-	8202 0303 03
BAL 20	3/4	19	75	55	-	8202 0304 02
BAL 25	1	24.5	90	64	-	8202 0305 01
BAL-1A 08	1/4	8	43	44	73	8202 0306 03
BAL-1A 10	3/8	10	50	47	73	8202 0306 11
BAL-1A 15	1/2	15	61	53	94	8202 0306 29
BAL-1A 20	3/4	20	70	57	94	8202 0306 37
BAL-1A 25	1	25	83	67.5	122	8202 0306 45
BAL-1A 32	1 1/4	32	100	83	150	8202 0306 52
BAL-1A 40	1 1/2	38	107	87	150	8202 0306 60
BAL-1A 50	2	50	129	103	193	8202 0306 78

Technical data

BAL

Maximum working pressure: 16 bar.
Working temperature range: -20oC to +90oC.

BAL-1A

Maximum working pressure: 16 bar (BAL-1A 40 and 50: max. 16 bar up to +100oC).
Working temperature range: -30oC to +200oC. (BAL-1A 40 and 50: at +200oC max working pressure is reduced to 8 bar).

Dimensions

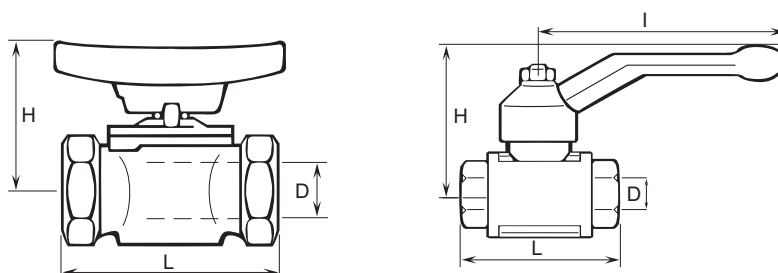

Swivel Connectors

MultiFlex



The MultiFlex swivel is an ingenious multi-directional connector. Connect your tool and the hose will stay in the ideal position however much you and the tool move around. The MultiFlex bends and rotates 360° in all directions while the hose stays straight. It takes the effort out of working in those cramped spaces. What’s more, the hose feels almost weightless and it reduces hose wear. It’s the magic of MultiFlex – a marriage of ergonomic thinking and ingenious design.

- Ergonomic.
- Reduces hose wear.
- High flow capacity.
- Minimum pressure drop.
- Strong and durable.
- Available with rubber (EPDM) protective cover.
- Fits most pneumatic tools.

Model	Max rec. air flow ^a		Thread		Weight g	Length mm	Dia mm	Ordering No.
	l/s	cfm	Inlet female in	Outlet male in				
Standard								
MultiFlex 1/8" BSP	12	25	1/8	1/8	73	66.2	24	8202 1350 18
MultiFlex 1/4" BSP	12	25	1/4	1/4	73	66.2	24	8202 1350 20
MultiFlex 3/8" BSP	32	68	3/8	3/8	130	80.6	29.5	8202 1350 22
MultiFlex 1/2" BSP	32	68	1/2	1/2	125	80.6	29.5	8202 1350 24
Protective rubber cover								
MultiFlex 1/8" BSP	12	25	1/8	1/8	76	66.2	27	8202 1350 40
MultiFlex 1/4" BSP	12	25	1/4	1/4	76	66.2	27	8202 1350 41
MultiFlex 3/8" BSP	32	68	3/8	3/8	130	80.6	29.5	8202 1350 42
High air flow								
MultiFlex 1/2" BSP	54	114	1/2	1/2	326	98.3	39	8202 1350 60
Female to male thread								
FBSP 1/4" - MBSP 1/8"	12	25	1/4	1/8	73	66.2	24	8202 1350 67

The pressure drop will be 0.2 bar at an inlet pressure of 6 bar.



SIMPLE PRESSURE CLAMPS FOR PVC HOSES

For CABLAIR	For PVC	One-lugged steel clamp mm	Ordering No.
–	–	5.2- 6.2	0347 0122 18
–	–	5.9- 7.0	0347 0122 19
–	03	7.0- 8.5	0347 0122 05
06	05	8.5-10.0	0347 0122 06
08	06	9.8-11.8	0347 0122 07
–	08	11.3-13.3	0347 0122 08
10	–	12.8-14.8	0347 0122 09
–	10	14.6-16.8	0347 0122 10
13	–	16.5-18.8	0347 0122 11
–	13	18.0-20.3	0347 0122 12
16	–	20.2-22.8	0347 0122 13
–	–	22.0-24.8	0347 0122 14
20	–	23.3-26.3	0347 0122 15
–	–	26.5-30.0	0347 0122 16
25	–	29.8-33.1	0347 0122 22



MEDIUM PRESSURE CLAMPS FOR PVC HOSES

For CABLAIR	For PVC, POLUR	Medium clamp worm drive mm	Ordering No.
–	–	8.0-14.0	0347 6102 00
–	08	11.0-17.0	0347 6103 00
–	10	11.0-17.0	0347 6103 00
–	–	13.0-20.0	0347 6104 00
16	13	15.0-24.0	0347 6105 00
20	16	19.0-28.0	0347 6106 00
–	20	22.0-32.0	0347 6107 00
25	25	26.0-38.0	0347 6109 00
–	–	32.0-44.0	0347 6111 00
–	–	38.0-50.0	0347 6112 00
–	–	50.0-65.0	0347 6113 00



MEDIUM PRESSURE CLAMPS FOR RUBBER HOSES

For TURBO	For RUBAIR	Medium clamp worm drive mm	Ordering No.
–	06	11.0-17.0	0347 6103 00
13	10	13.0-20.0	0347 6104 00
16	13	15.0-24.0	0347 6105 00
–	16	19.0-28.0	0347 6106 00
20	–	22.0-32.0	0347 6107 00
–	20	26.0-38.0	0347 6109 00



HEAVY-DUTY PRESSURE CLAMPS FOR RUBBER HOSES

For TURBO	For RUBAIR	Heavy-duty clamp mm	Ordering No.
–	–	22.0-25.0	9000 0194 00
20	16	25.0-28.0	9000 0195 00
–	20	29.0-32.0	9000 0196 00
–	25	34.0-38.0	9000 0197 00



HOSE CONNECTION

Male thread – hose nipple

Thread in	Hose size		Ordering No.
	mm	in	
1/8 BSP	3.2	1/8	9000 0523 00
1/8 BSPT	5	3/16	4010 0031 00
1/8 BSPT	6.3	1/4	9000 0240 00
1/4 BSP	3.2	1/8	9000 0524 00
1/4 BSPT	6.3	1/4	9000 0241 00
1/4 BSPT	8	5/16	9090 1715 00
1/4 BSPT	10	3/8	9000 0247 00
3/8 BSPT	10	3/8	9000 0242 00
3/8 BSPT	12.5	1/2	9000 0248 00
1/2 BSPT	12.5	1/2	9000 0243 00
1/2 BSPT	16	5/8	9000 0244 00
1/2 BSP	20	3/4	4150 0429 00
3/4 BSPT	20	3/4	9000 0245 00
1 BSPT	25	1	9000 0246 00



GASKETS

For couplings with male parallel thread	Fiber gasket between material and nipple Ordering No.
1/8 BSP	0657 5742 00
1/4 BSP	0657 5764 00
3/8 BSP	0657 5785 00
1/2 BSP	0653 0500 01
3/4 BSP	0657 5823 00
1 BSP	0657 5830 00



REDUCING NIPPLE IN BRASS

Female thread in	Male thread in	Ordering No.
1/4 BSP	1/8 BSP	9721 4000 94
3/8 BSP	1/4 BSP	9721 4000 92
1/2 BSP	3/8 BSP	9721 4000 93



SWIVELS

Air inlet	Air outlet Male BSP	Max Swivel bend from centre line	Ordering No.
5/16" hose	1/4	30°	4210 3134 80

Recommended flow max 10 l/s

Fittings



BUSHING

Male thread – female thread

Male thread in	Female thread in	Ordering No.
1/4 BSP	1/8 BSP	9090 0799 00
3/8 BSP	1/4 BSP	9090 0798 00
1/2 BSP	1/4 BSP	9090 1469 00
1/2 BSP	3/8 BSP	9090 0797 00
3/4 BSP	1/2 BSP	9090 0796 00
1 BSPT	3/4 BSP	9090 0795 00



DOUBLE CONNECTION

Male taper thread – male taper thread

From thread in	To thread in	Ordering No.
1/8 BSPT	1/8 BSPT	9090 0100 00
1/8 BSPT	1/4 BSPT	9090 0110 00
1/4 BSPT	1/4 BSPT	9090 0120 00
1/4 BSPT	3/8 BSPT	9090 0130 00
3/8 BSPT	3/8 BSPT	9090 0140 00
3/8 BSPT	1/2 BSPT	9090 0150 00
1/2 BSPT	1/2 BSPT	9090 0160 00
1/2 BSPT	3/4 BSPT	9090 0170 00
3/4 BSPT	3/4 BSPT	9090 0180 00
3/4 BSPT	1 BSPT	9090 0190 00
1 BSPT	1 BSPT	9090 0200 00



DOUBLE ADJUSTABLE CONNECTION

Male thread – male thread

From thread in	To thread in	Ordering No.
1/2 BSP	1/2 BSP	9090 0806 00



SEALING RINGS FOR DOUBLE ADJUSTABLE CONNECTION

For coupling with male thread in	Spare rubber sealing ring for adjustable connections Ordering No.
1/2 BSP	9090 0884 00
1 BSP	9090 0886 00

HOSE CONNECTION WITH CLAMP NUT AND SPRING GUARD



1 Clamp nut, brass

Hose diameter Outside/Inside mm	Male thread in	Ordering No.
10/8	1/4 BSP	9721 4002 89
12/10	3/8 BSP	9721 4000 88
15/12.5	1/2 BSP	9721 4000 89

Male threaded hose nipple with clamp nut should be used with female threaded quick couplings.

2 Spring guard in steel

Hose diameter Outside/Inside mm	Ordering No.
10/8	9721 4002 88
12/10	9721 4000 91
15/12	9721 4002 85

The spring guard should be used with the clamp nut above.



MANIFOLDS

3/8 inlet on each side, 1/4 outlets for couplings

Inlet in	Thread		Number of outlets	Ordering No.
	Inlet in	Outlet in		
3/8 BSP	1/4 BSP	1/4 BSP	4	9090 0201 00
3/8 BSP	1/4 BSP	1/4 BSP	5	9090 0201 01
3/8 BSP	1/4 BSP	1/4 BSP	6	9090 0201 02



MANIFOLDS

3/8 inlet on each side, 1/4 outlet on both sides for couplings

Inlet in	Thread		Number of outlets	Ordering No.
	Inlet in	Outlet in		
3/8 BSP	1/4 BSP	1/4 BSP	4	9090 0201 10
3/8 BSP	1/4 BSP	1/4 BSP	6	9090 0201 11
3/8 BSP	1/4 BSP	1/4 BSP	8	9090 0201 12
3/8 BSP	1/4 BSP	1/4 BSP	10	9090 0201 13



Y-CONNECTIONS

2 female outlets and 1 male inlet

Model	Female thread in	Male thread in	Ordering No.
F/F/M08	1/4 BSP	1/4 BSP	9090 0201 86
F/F/M10	3/8 BSP	3/8 BSP	9090 0201 87
F/F/M15	1/2 BSP	1/2 BSP	9090 0201 85



PIPE TEE

Model	Female threads in	Ordering No.
F08	1/4 BSP	9090 0201 51
F10	3/8 BSP	9090 0201 53
F15	1/2 BSP	9090 0201 50
F20	3/4 BSP	9090 0201 52
F25	1 BSP	9090 0201 54



PIPE CROSS

Model	Female thread in	Ordering No.
F08	1/4 BSP	9090 0201 21
F10	3/8 BSP	9090 0201 22
F15	1/2 BSP	9090 0201 20



BRANCH TEE

2 female outlets and 1 male inlet

Model	Female thread in	Male thread in	Ordering No.
2xF08 1xM08	1/4 BSP	1/4 BSP	9090 0201 61
2xF10 1xM10	3/8 BSP	3/8 BSP	9090 0201 63
2xF15 1xM15	1/2 BSP	1/2 BSP	9090 0201 60
2xF20 1xM20	3/4 BSP	3/4 BSP	9090 0201 62
2xF25 1xM25	1 BSP	1 BSP	9090 0201 64



CROSS

3 female threads and 1 male thread

Model	Female thread in	Male thread in	Ordering No.
3xF08 1xM08	1/4 BSP	1/4 BSP	9090 0201 31
3xF10 1xM10	3/8 BSP	3/8 BSP	9090 0201 32
3xF15 1xM15	1/2 BSP	1/2 BSP	9090 0201 30



RUN TEE

2 female outlets and 1 male inlet

Model	Female thread in	Male thread in	Ordering No.
F08/M08/F08	1/4 BSP	1/4 BSP	9090 0201 71
F10/M10/F10	3/8 BSP	3/8 BSP	9090 0201 72
F15/M15/F15	1/2 BSP	1/2 BSP	9090 0201 70



PIPE ELBOW

Model	Female thread in	Ordering No.
F08	1/4 BSP	9090 0201 40
F10	3/8 BSP	9090 0201 43
F15	1/2 BSP	9090 0201 41
F20	3/4 BSP	9090 0201 42
F25	1 BSP	9090 0201 44



HEX HEAD PLUG

Model	Male thread in	Ordering No.
M08	1/4 BSP	9090 0201 81
M10	3/8 BSP	9090 0201 84
M15	1/2 BSP	9090 0201 80
M20	3/4 BSP	9090 0201 83
M25	1 BSP	9090 0201 82

Pressure drop diagram for straight hoses

This diagram helps you to choose the right hose according to the air consumption of the tool and the length of the hose. The purpose of the diagram is to ensure that the pressure drop in the hoses does not exceed 0.2 bar.

PRESSURE DROP DIAGRAM FOR HOSES

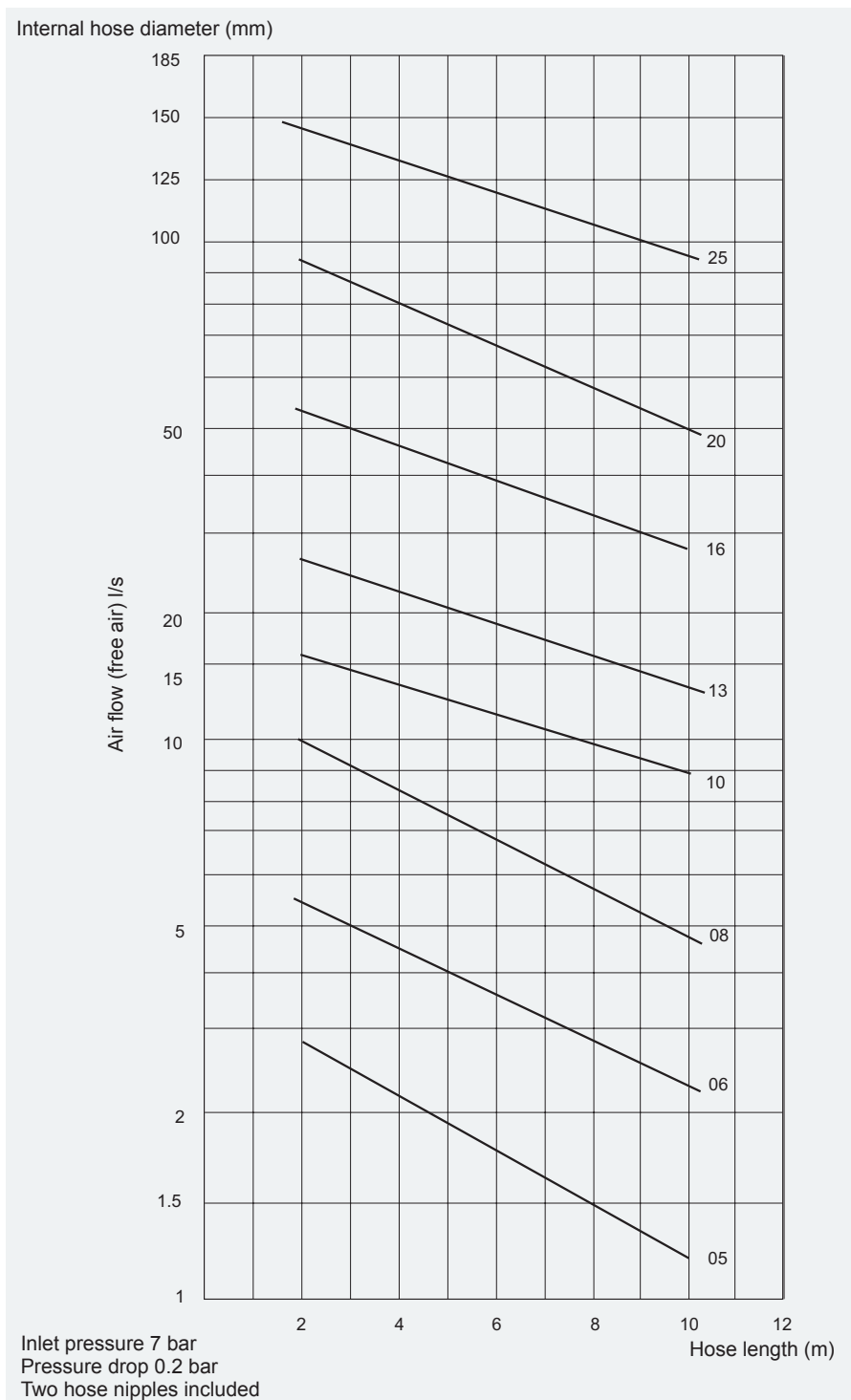

HOW TO READ THE DIAGRAM:

Look up the tools required air consumption at 6 bar.

Use this value in the diagram .

What length of hose do you need?

Look at the diagram to see which hose size you need.

Decide which type of hose you need, Atlas Copco Tools has seven different hoses covering all types of needs for pneumatic hand tools.

EXAMPLE

The tool has an air consumption of 10 l/s and the application requires a hose length of 7 m. These two values have a cross point slightly under the 10 mm size hose (7 m of 10 mm hose gives a value of approximately 11 l/s).

Therefore a 10 mm hose will be suitable.



CABLAIR hoses

Super-light flexible PVC-hose

Cablair is made of high-strength, high performance PVC compound. The Cablair hose weighs 30-50% less and is much softer and more flexible than conventional PVC hoses. This ensures complete freedom of movement for operators of pneumatic hand tools.

Model	Hose inside dia		Hose outside dia		Max working pressure ^a bar	Max rec. air flow ^b l/s	Weight per 30 m coil kg	Ordering No.
	mm	in	mm	in				
CABLAIR 06	6	1/4	8.5		14	4	1.2	9093 0035 11
CABLAIR 08	8	1/3	11		14	7.5	1.7	9093 0035 41
CABLAIR 10	10	2/5	13		12	13	2.1	9093 0035 71
CABLAIR 13	12.5	1/2	16		11	21	3.0	9093 0036 01
CABLAIR 16	16	5/8	21		8	43	5.4	9093 0036 31
CABLAIR 20	19	3/4	24		8	75	5.8	9093 0036 61
CABLAIR 25	25	1	31.5		7	125	10.4	9093 0036 91

^a With a safety factor of 3 at 20°C (at the max temp of +60°C the working pressure should be reduced by 50%).

^b The pressure drop will be 0.2 bar on a hose length of 5 m.

- Low weight.
- Extremely soft and flexible.
- Silicone free.
- Ergonomic.
- Working temperature -15°C to +60°C.

CABLAIR ESD

Extra flexible antistatic air hose

Cablair ESD is designed specifically for use within the computer manufacturing industry. The hose possesses properties which enable ESDS (electrostatic sensitive devices) to be handled in a protected area with a low risk level, as a result of electrostatic discharge. In addition to a known demand in the computer industry, it is expected that potential exists in the electronics, radio and communication fields. The connection device must be earthed/grounded.

- Extra flexible.
- Antistatic.
- Silicone free.
- Testing in accordance with BS2050:1978 (1998) 4.12.
- Working temperature -15°C to +60°C.



Model	Hose inside dia		Hose outside dia		Max working pressure ^a bar	Max rec. air flow l/s	Weight per 30 m coil kg	Ordering No.
	mm	in	mm	in				
CABLAIR ESD 06	6	1/4	11	7/16	10	4	2.34	8202 0501 06
CABLAIR ESD 08	8	5/16	12	1/2	9	7.5	2.56	8202 0501 08
CABLAIR ESD 10	10	3/8	14	9/16	8	13	2.71	8202 0501 10
CABLAIR ESD 13	13	1/2	18	23/32	7	21	4.41	8202 0501 13

^a With a safety factor of 3 at 20°C (at the max temp of +60°C the working pressure should be reduced by 50%).

Hoses

PVC, POLUR

PVC hoses

Strong PVC hose for heavy-duty applications

PVC hose has high resistance to abrasion, which makes it the ideal hose for tough working environments such as workshops, factories, garages, etc. It is mainly recommended for indoor use.

- Long service life.
- Pliable.
- Transparent.
- Working temperature -15°C to +60°C.



Model	Hose inside dia		Hose outside dia mm	Max working pressure ^a bar	Max rec. air flow ^b l/s	Weight per 30 m coil kg	Ordering No.
	mm	in					
PVC 03	3.2	1/8	7	20	0.7	1.4	9093 0037 21
PVC 05	5	3/16	9	10	2.1	1.9	9093 0037 51
PVC 06	6.3	1/4	11	10	4	2.5	9093 0037 81
PVC 08	8	5/16	12	10	7.5	2.9	9093 0038 11
PVC 10	10	3/8	14	14	13	3.7	9093 0038 41
PVC 13	12.5	1/2	18	13	21	5.9	9093 0038 71
PVC 16	16	5/8	22	12	43	7.2	9093 0039 01
PVC 20	19	3/4	25	10	75	8.3	9093 0039 31
PVC 25	25	1	32	10	125	12.5	9093 0039 61

^a With a safety factor of 3 at 20°C (at the max temp of +60°C the working pressure should be reduced by 50%).

^b The pressure drop will be 0.2 bar on a hose length of 5 m.

POLUR

High resistant polyurethane hose

Polur hose is the most environmentally friendly solution. It has high resistance to abrasion and it is oil resistant. Polur hose has a much longer lifetime than PVC hoses. Polur is ideal in tough working conditions such as workshops, factories, garages, shipyards and construction sites due to its flexibility, even at minus degrees. Polur is recommended for indoor and outdoor use.

- Oil resistant.
- Flexible.
- Long service life.
- Working temperature -30°C to +60°C.

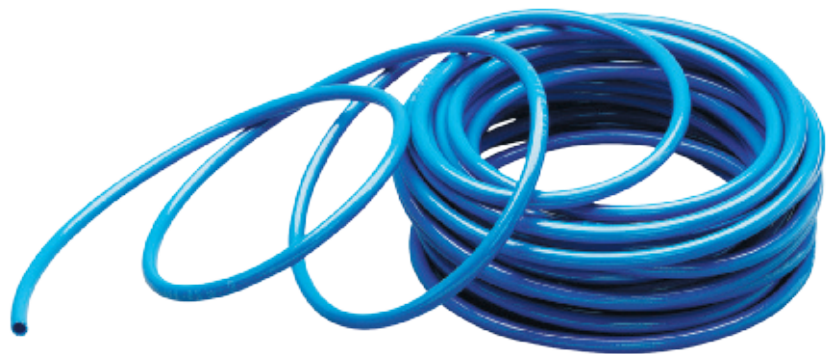

Model	Hose inside dia		Hose outside dia mm	Max working pressure ^a bar	Max rec. air flow ^b l/s	Weight per 25 m coil kg	Ordering No.
	mm	in					
POLUR 08	8	5/16	12	20	7.5	2.2	8202 0601 08
POLUR 10	10	3/8	14	16	13	2.5	8202 0602 10
POLUR 13	13	1/2	18	13	21	4.0	8202 0603 13

^a With a safety factor of 3 at 20°C (at the max temp of +60°C the working pressure should be reduced by 50%).

^b The pressure drop will be 0.2 bar on a hose length of 5 m, including 2 nipples and at an inlet pressure of 7 bar.



TURBO

Super-light flexible rubber hose

Turbo hose has been developed for flexible use both indoor and outdoor. The hose weighs 30-40% less than conventional rubber hoses, making it ideal for foundries, shipyards, engineering workshops and construction sites. Turbo hose is oil resistant.

- Extremely low weight.
- Soft and flexible.
- Antistatic.
- Grinding and welding spatter resistant.
- Working temperature -30°C to +70°C.

Model	Hose inside dia		Hose outside dia mm	Max working pressure ^a bar	Max rec. air flow ^b l/s	Weight per		Ordering No.
	mm	in				20 m coil kg	30 m coil kg	
TURBO 13	13	1/2	19	20	21	3.9	–	9093 0057 91
TURBO 13	13	1/2	19	20	21	–	5.9	9093 0057 93
TURBO 16	16.8	2/3	22.8	20	43	4.8	–	9093 0057 31
TURBO 16	16.8	2/3	22.8	20	43	–	7.2	9093 0057 33
TURBO 20	21	5/6	27	20	75	5.4	–	9093 0057 61
TURBO 20	21	5/6	27	20	75	–	8.1	9093 0057 62

^a With a safety factor of 3 at 20°C.

^b The pressure drop will be 0.2 bar on a hose length of 5 m, including 2 nipples and at an inlet pressure of 7 bar.



RUBBER

Durable reinforced extra thick heavy duty rubber hose

The hose withstands rough handling and is suitable for the most demanding tasks in construction, mining, shipyards, foundries etc. The inner lining is black EPDM rubber, conductive to dissipate static electricity. Reinforcement with high tensile strength made of synthetic textile yarns.

- Durable.
- Antistatic.
- Grinding and welding spatter resistant.
- Working temperature -25°C to +70°C.

Model	Hose inside dia		Hose outside dia mm	Max working pressure ^a bar	Max rec. air flow ^b l/s	Length m	Weight kg	Ordering No.
	mm	in						
RUBBER	6.3	1/4	12	16	4	30	3.5	9030 2036 00
RUBBER	10	3/8	17	16	13	30	6.9	9030 2037 00
RUBBER	12.5	1/2	22	16	21	30	12.3	9030 2038 00
RUBBER	16	5/8	25	16	43	30	13.9	9030 2039 00
RUBBER	20	3/4	30	16	75	30	19.3	9030 2040 00
RUBBER	20	3/4	30	16	75	20	12.9	9030 2040 03
RUBBER	25	1	36	16	125	30	24.0	9030 2041 00
RUBBER	25	1	36	16	125	20	16.0	9030 2041 03

^a With a safety factor of 5 at 20°C.

^b The pressure drop will be 0.2 bar on a hose length of 5 m, including 2 nipples and at an inlet pressure of 7 bar.

RUBAIR

Durable reinforced heavy duty rubber hose

Rubair hose is double reinforced to fulfil all general heavy duty demands and is recommended for indoor and outdoor use. Rubair hose is oil resistant.

- Durable.
- Antistatic.
- Grinding and welding spatter resistant.
- Working temperature -20°C to +80°C.



Model	Hose inside dia		Hose outside dia mm	Max working pressure ^a bar	Max rec. air flow ^b l/s	Weight per 20 m coil kg	Ordering No.
	mm	in					
RUBAIR 10	10	3/8	16.0	16	13	3.6	8202 0402 10
RUBAIR 13	12.5	1/2	19.1	16	21	4.7	8202 0403 13
RUBAIR 16	16	5/8	23.0	16	43	6.1	8202 0404 16
RUBAIR 20	20	3/4	26.6	16	75	7.8	8202 0405 20

^a With a safety factor of 5 at 20°C.

^b The pressure drop will be 0.2 bar on a hose length of 5 m, including 2 nipples and at an inlet pressure of 7 bar.

SPI
Elastic hose for vertical and horizontal applications

SPI elastic spiral hose is ideal for air tools used at varying distances from a fixed air outlet. It is easily stretched and retracts immediately when released. When used with hand tools, its self-storage principle ensures that the hose is kept off the floor and out of the way of the operator. The SPI 1 and SPI 2 have ball bearing swivels fitted on the long hose side to allow 360° rotation. All spiral hoses, except the SPI4, are fitted with plastic spring guard. SPI is the ideal hose in combination with a balancer.

- Self-retractable.
- Light and flexible.
- Strong and durable.
- Tubing material: Polyurethane (100% PUR).
- Hardness: Shore A 98 +2.
- Colour: Blue.
- Working pressure: 8 bar at 23°C.
- Burst pressure: 25 bar at 23°C.
- Temperature range: -40°C to +70°C.



Model	Hose inside dia mm	Hose outside dia mm	Max. rec. air flow ^a l/s	Working range m	Length			Max spiral dia mm (D)	Male threads in BSP	Ordering No.
					(A) mm	(B) mm	(C) mm			
SPI 1SPSW-S	6.5	10	7	2	500	165	150	55	1/4	8202 0508 71
SPI 1SPSW-M	6.5	10	5	4	500	330	150	55	1/4	8202 0508 73
SPI 2SPSW-S	8	12	13	2	500	130	150	70	3/8	8202 0508 75
SPI 2SPSW-M	8	12	10	4	500	270	150	70	3/8	8202 0508 77
SPI 2SPSW-L	8	12	9	6	500	435	150	70	3/8	8202 0508 79
SPI 2SPSW-XL	8	12	6	8	500	600	150	70	3/8	8202 0508 81
SPI 3SP-S	11	16	25	2	500	135	150	98	3/8	8202 0508 82
SPI 3SP-M	11	16	22	4	500	260	150	98	3/8	8202 0508 84
SPI 3SP-L	11	16	17	6	500	390	150	98	3/8	8202 0508 86
SPI 3SP-XL	11	16	13	8	500	550	150	98	3/8	8202 0508 88
SPI 4SP-XXL	13	19	21	10	500	850	500	115	3/8	8202 0508 90

^a At inlet pressure 6 bar and pressure drop 0.5 bar.

Dimensions

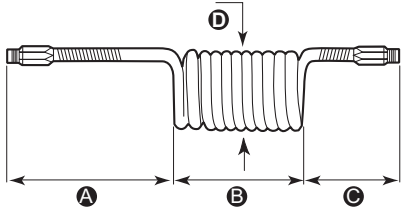

Productivity Kits

Productivity kits boost productivity, extend tool lifetime and ensure minimum pressure drop. Each productivity kit includes ball valve, air preparation unit, and the couplings, hose and nipples needed for correct and safe installation of the tool. Just choose the correct productivity kit based on the air flow requirement of the tool and whether the tool needs lubrication or not. You'll be surprised how much the productivity kit improves the performance of the tool.

- Improves the performance of the tool.
- Fast and easy installation.
- Extends tool lifetime.



PRODUCTIVITY KITS FOR SCREWDRIVERS, DRILLS AND GRINDERS

Model	Max air flow	Hose, 5 m	Coupling	Lubrication	Ordering No.
For small screwdrivers and small drills with 1/8" BSP air inlet					
MIDI-FRL-1/2-BSP EQ08-C06-1/8	6 l/s	Cablair 6 mm	ErgoQIC 08	Yes	8202 0850 10
MIDI-FRL-1/2-BSP EQ08-C06-1/8	6 l/s	Cablair 6 mm	ErgoQIC 08	No	8202 0850 19
For screwdrivers and drills with 1/4" BSP air inlet					
MIDI-FRL-1/2-BSP EQ08-C08	9 l/s	Cablair 8 mm	ErgoQIC 08	Yes	8202 0850 00
MIDI-FRL-1/2-BSP EQ08-C08	9 l/s	Cablair 8 mm	ErgoQIC 08	No	8202 0850 01
For 1/2" drills and small nutrunners with 3/8" BSP air inlet					
MIDI-FRL-1/2-BSP EQ08-C10	16 l/s	Cablair 10 mm	ErgoQIC 08	Yes	8202 0850 07
For 1/2" small nutrunners with 1/4" BSP air inlet					
MIDI-FRL-1/2-BSP EQ08-C10	16 l/s	Cablair 10 mm	ErgoQIC 08	Yes	8202 0850 03
MIDI-FRL-1/2-BSP EQ10-R10	16 l/s	Rubair 10 mm	ErgoQIC 10	Yes	8202 0850 16
For percussive tools and grinders with 3/8" BSP air inlet incl. whiphose					
MIDI-FRL-1/2-BSP EQ10-R13-W	23 l/s	Rubair 13 mm	ErgoQIC 10	Yes	8202 0850 14
For percussive tools and grinders, incl. whiphose, no tool nipple included					
MIDI-FRL-1/2-BSP EQ10-R13-W	23 l/s	Rubair 13 mm	ErgoQIC 10	Yes	8202 0850 15
For drills and nutrunners with 3/8" BSP air inlet					
MIDI Optimizer F/RD EQ10-C13	23 l/s	Cablair 13 mm	ErgoQIC 10	Yes	8202 0850 02
For drills and nutrunners with 1/4" BSP air inlet					
MIDI-FRL-1/2-BSP EQ10-C13	23 l/s	Cablair 13 mm	ErgoQIC 10	Yes	8202 0850 11
For grinders and nutrunners with 3/8" BSP air inlet					
MIDI-FRL-1/2-BSP EQ10-T13	35 l/s	Turbo 13 mm	ErgoQIC 10	Yes	8202 0850 17
MIDI-FRL-1/2-BSP EQ10-T16 (For LSV39)	35 l/s	Turbo 16 mm	ErgoQIC 10	Yes	8202 0850 42
For grinders and nutrunners with 1/2" BSP air inlet					
MAXI-F/R-1-BSP EQ10-T13	35 l/s	Turbo 13 mm	ErgoQIC 10	No	8202 0850 04
MAXI-F/R-1-BSP EQ10-T13	35 l/s	Turbo 13 mm	ErgoQIC 10	Yes	8202 0850 13
For grinders with 1/2" BSP air inlet					
MIDI-FRL-1/2-BSP EQ10-T16	40 l/s	Turbo 16 mm	ErgoQIC 10	Yes	8202 0850 12
For large Turbo grinders with 1/2" BSP air inlet					
MAXI-F/R-1-BSP C-T16	60 l/s	Turbo 16 mm	Claw	No	8202 0850 05

PRODUCTIVITY KITS FOR IMPACT WRENCHES AND PULSE TOOLS

Model	Max air flow	Hose, 5 m	Coupling	Lubrication	Ordering No.
For small impacts and pulse tools with 1/4" BSP air inlet					
MIDI-FRL-1/2-BSP EQ08-C08	9 l/s	Cablair 8 mm	ErgoQIC 08	Yes	8202 0850 00
For 1/2" impact wrenches and pulse tools with 3/8" BSP air inlet					
MIDI-FRL-1/2-BSP EQ08-C10	16 l/s	Cablair 10 mm	ErgoQIC 08	Yes	8202 0850 07
For 1/2" impact wrenches and pulse tools with 1/4" BSP air inlet					
MIDI-FRL-1/2-BSP EQ08-C10	16 l/s	Cablair 10 mm	ErgoQIC 08	Yes	8202 0850 03
MIDI-FRL-1/2-BSP EQ08-C10	16 l/s	Rubair 10 mm	ErgoQIC 10	Yes	8202 0850 16
For impact wrenches and pulse tools with 3/8" BSP air inlet					
MIDI-FRL-1/2-BSP EQ10-C13	23 l/s	Cablair 13 mm	ErgoQIC 10	Yes	8202 0850 02
For impact wrenches and pulse tools with 1/2" BSP air inlet					
MIDI-FRL-1/2-BSP EQ10-T13	35 l/s	Turbo 13 mm	ErgoQIC 10	Yes	8202 0850 13

Pre-mounted Hose Kits

Pre-mounted hose kits

Atlas Copco hose kits provides an easy way to choose the right hose and coupling combination for pneumatic tools. Each kit is ready for immediate use without the need of assembly tools.

- Correct combination hose – coupling.
- Leak free hose connections.
- Immediate use.



HOSE KITS

Hose	Hose inside dia mm	Length m	Nipple	Coupling	Air inlet thread nipple	Ordering No.
Cablair	6	5	ErgoNIP 08	ErgoQIC 08	1/8" BSP	8202 1182 01
Cablair	6	5	ErgoNIP 10	ErgoQIC 08	1/8" BSP	8202 1180 67
Cablair	8	5	ErgoNIP 08	ErgoQIC 08	1/4" BSP	8202 1182 02
Cablair	8	5	NIP 08	ErgoQIC 08US	-	8202 1182 21
Cablair	8	5	ErgoNIP 10	ErgoQIC 08	1/4" BSP	8202 1180 77
Cablair	10	5	ErgoNIP 08	ErgoQIC 08	1/4" BSP	8202 1182 03
Cablair	10	5	ErgoNIP 10	ErgoQIC 08	1/4" BSP	8202 1180 30
Cablair	12.5	5	ErgoNIP 10	ErgoQIC 10	3/8" BSP	8202 1180 79
Cablair	12.5	5	ErgoNIP 10	ErgoQIC 10	-	8202 1182 10
Cablair	12.5	5	NIP 10US	ErgoQIC 10US	-	8202 1182 18
Cablair	12.5	8.5	ErgoNIP 10	ErgoQIC 10	-	8202 1182 20
Cablair	12.5	10	ErgoNIP 10	ErgoQIC 10	-	8202 1182 15
PVC	10	5	ErgoNIP 10	ErgoQIC 10	1/4" BSP	8202 1180 18
PVC	10	5	ErgoNIP 10	ErgoQIC 08	3/8" BSP	8202 1180 31
Rubair	10	5	ErgoNIP 10	ErgoQIC 10	3/8" BSP	8202 1180 20
Rubair	10	5	ErgoNIP 10	ErgoQIC 10	1/4" BSP	8202 1180 43
Rubair	12.5	5	NIP 10US	ErgoQIC 10US	-	8202 1182 24
Rubair	20	5	CLAW	ErgoQIC 10	-	8202 1180 24
Turbo	12.5	5	ErgoNIP 10	ErgoQIC 10	3/8" BSP	8202 1182 07
Turbo	12.5	5	ErgoNIP 10	ErgoQIC 10	1/2" BSP	8202 1180 22
Turbo	12.5	5	NIP 10US	ErgoQIC 10US	-	8202 1182 19
Turbo	16.8	5	ErgoNIP 10	ErgoQIC 10	1/2" BSP	8202 1180 34
Turbo	16.8	5	CLAW	ErgoQIC 10	1/2" BSP	8202 1181 80
Turbo	16.8	5	NIP 15US	ErgoQIC 15US	-	8202 1182 22
Turbo	16.8	10	ErgoNIP 10	ErgoQIC 10	-	8202 1180 46
Turbo	21	20	CLAW	ErgoQIC 10	-	8202 1181 75
Turbo	16	5	ErgoNIP-10-M10	ErgoQIC 10	-	8202 1180 51



WHIP HOSE KITS

Hose	Hose inside dia mm	Length m	Nipple	Male thread	Ordering No.
Cablair	10	0.7	ErgoNIP 10	1/4" BSPT	8202 1180 19
Cablair	10	1.5	ErgoNIP 10	1/4" BSPT	8202 1182 30
Cablair	10	1.5	ErgoNIP 10	3/8" BSPT	8202 1182 35
Cablair	10	0.7	ErgoNIP 08	1/4" BSPT	8202 1180 47
PVC	10	0.7	ErgoNIP 08	3/8" BSPT	8202 1180 50
Rubair	10	0.7	ErgoNIP 10	1/4" BSPT	8202 1180 42
Rubair	10	0.7	ErgoNIP 10	3/8" BSPT	8202 1180 44
Rubair	12.5	0.7	ErgoNIP 10	1/2" BSPT	8202 1180 23
Turbo	16.8	0.5	ErgoNIP 10	1/2" BSPT	8202 1180 28
Turbo	16.8	5	CLAW	1/2" BSPT	8202 1181 95

Pre-mounted Hose Kits and Whip Hoses

Pre-mounted hose kits

Atlas Copco SmartQIC hose kits provides an easy & safe way to choose the right hose and coupling combination for pneumatic tools. Each kit is ready for immediate use without the need of assembly tools.

- Correct combination hose – coupling.
- Leak free hose connections.
- Plug & Play



HOSE KITS AND WHIP HOSES

Market	Application	Nipples included	Max rec. air flow		Max working pressure		Ordering No.	
			l/s	cfm	bar	psi		
EU 7.6								
SmartQIC 08E	Hose kit	Assembly	1/4"	7.5	15.9	14	203	4221 0000 80
		Assembly	1/4" and 3/8"	13	27.5	12	174	4221 0000 81
		Assembly	1/4" and 3/8"	13	27.5	12	174	4221 0000 82
		Assembly	3/8" and 1/2"	21	44.5	11	160	4221 0000 85
		Assembly	3/8" and 1/2"	21	44.5	11	160	4221 0000 86
		Heavy Duty	3/8" and 1/2"	21	44.5	20	290	4221 0000 83
	Heavy Duty	3/8" and 1/2"	21	44.5	20	290	4221 0000 84	
	Whip hose	Assembly	1/4"	7.5	15.9	14	203	4221 0001 09
		Assembly	3/8"	13	27.5	12	174	4221 0001 10
		Assembly	3/8"	21	44.5	11	160	4221 0001 11
EU 10.4								
SmartQIC 15E	Hose kit	Assembly	3/8" and 1/2"	21	44.5	11	160	4221 0000 89
		Assembly	3/8" and 1/2"	21	44.5	11	160	4221 0000 90
		Heavy Duty	3/8" and 1/2"	21	44.5	20	290	4221 0000 87
		Heavy Duty	3/8" and 1/2"	21	44.5	20	290	4221 0000 88
		Heavy Duty	1/2" and 3/4"	43	91.1	20	290	4221 0000 91
		Heavy Duty	1/2" and 3/4"	43	91.1	20	290	4221 0000 92
	Whip hose	Heavy Duty	3/8"	21	44.5	20	290	4221 0001 12
		Heavy Duty	1/2"	43	91.1	20	290	4221 0001 13
	ISO 6150-B – US/Global							
	SmartQIC 08US	Hose kit	Assembly	1/4"	7.5	15.9	14	203
Assembly			1/4" and 3/8"	13	27.5	12	174	4221 0000 94
Assembly			1/4" and 3/8"	13	27.5	12	174	4221 0000 95
Assembly			3/8"	13	27.5	12	174	4221 0001 14
SmartQIC 10US	Hose kit	Assembly	1/4" and 3/8"	13	27.5	12	174	4221 0001 01
		Assembly	1/4" and 3/8"	13	27.5	12	174	4221 0001 02
		Assembly	3/8" and 1/2"	21	44.5	11	160	4221 0001 05
		Assembly	3/8" and 1/2"	21	44.5	11	160	4221 0001 06
		Heavy Duty	3/8" and 1/2"	21	44.5	20	290	4221 0001 03
		Heavy Duty	3/8" and 1/2"	21	44.5	20	290	4221 0001 04
	Whip hose	Assembly	3/8"	13	27.5	12	174	4221 0001 17
		Assembly	3/8"	21	44.5	11	160	4221 0001 18
		Heavy Duty	3/8"	21	44.5	20	290	4221 0001 19
	SmartQIC 15US	Hose kit	Assembly	3/8" and 1/2"	21	44.5	11	160
Assembly			3/8" and 1/2"	21	44.5	11	160	4221 0000 98
Heavy Duty			3/8" and 1/2"	21	44.5	20	290	4221 0000 96
Heavy Duty			1/2" and 3/4"	75	158.9	20	290	4221 0000 99
Heavy Duty			1/2" and 3/4"	75	158.9	20	290	4221 0001 00
Whip hose		Assembly	3/8"	21	44.5	11	160	4221 0001 15
	Heavy Duty	3/8"	21	44.5	20	290	4221 0001 16	
Asia								
SmartQIC 10A	Hose kit	Assembly	1/4"	7.5	15.9	14	203	4221 0001 07
		Assembly	1/4" and 3/8"	13	27.5	12	174	4221 0001 08

HM LIGHT

The HM Light has a robust design with a high impact composite casing. The outlet slot is optimized to provide an ideal pull-out angle for the hose. The HM Light is recommended for small and medium screwdrivers, small and medium pulse tools, small drills, impact wrenches up to 1/2" size and riveting and chipping hammers.

- Snap-on, pivoting wall bracket.
- PVC/PUR hose.
- Hose end provided with pressed fitting and steel spiral hose protector (NPT and BSP).
- Hose easily replaced when needed.
- Drum with ball bearings on both sides.
- Working temperature: 0°C - +50°C.
- Inlet hose length: 1 m.



Model	Hose length m	Hose type	Hose inside dia		Connection inlet hose inside dia (cut of hose) mm	Connection distribution hose BSP	Max working pressure bar	Economical air flow (at 0.2 bar pressure drop) l/s	Max air flow capacity (at 0.5 bar pressure drop) l/s	Weight kg	Ordering No.
			mm	in							
HM LIGHT 8-8	8	PVC/PUR	8	5/16	10	1/4	12	4	7	3	8202 1183 30
HM LIGHT 8-12	12	PVC/PUR	8	5/16	10	1/4	15	3	5	5	8202 1183 31
HM LIGHT 10-10	10	PVC/PUR	10	3/8	10	3/8	15	6	10	5	8202 1183 32

Dimensions

HM LIGHT 8-8 (8-12)

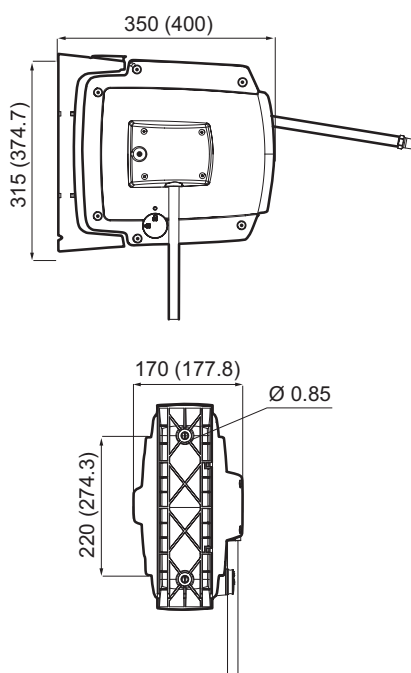

Flow chart

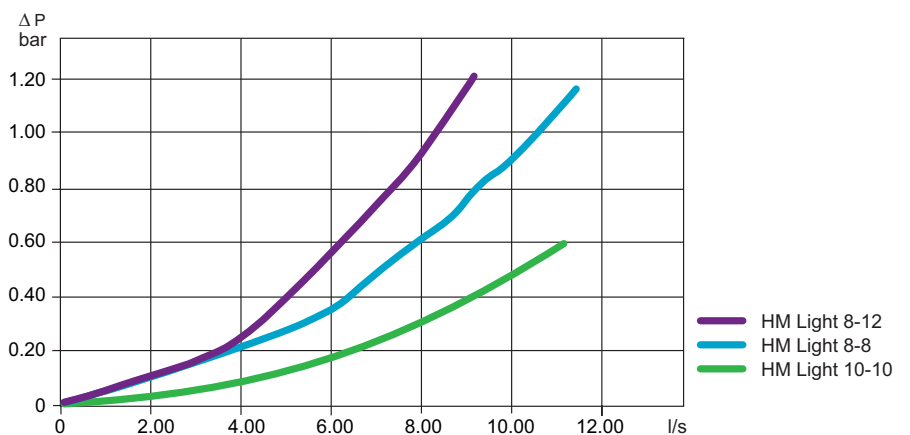

Hose Reels

HM Open

HM OPEN

The HM Open has an open composite casing, steel frame and 10 mm or 13 mm hose. HM Open is a reliable, medium sized hose reel recommended for screwdrivers, impact wrenches, pulse tools, drills, chipping and riveting hammers and grinders up 1000 W.

- Spatter resistant rubber hose.
- Outlet roller position can be adjusted through 120 degrees for optimal pull-out angle.
- Hose end provided with steel spiral hose protector (NPT and BSP).
- Latch function is easily disengaged.
- Spring tension is easily adjusted.
- Floor, wall or ceiling mounting.
- Working temperature: -10°C - +60°C.
- Max working pressure: 15 bar.
- Inlet hose length: 1 m.



Model	Hose length m	Hose type	Hose inside dia		Connection inlet hose inside dia (cut of hose) mm	Connection distribution hose BSP	Economical air flow (at 0.2 bar pressure drop) l/s	Max air flow capacity (at 0.5 bar pressure drop) l/s	Weight	
			mm	in					kg	Ordering No.
HM OPEN 10-15	15	Rubber	10	3/8	12.5	3/8	5	9	11	8202 1183 33
HM OPEN 10-20	20	Rubber	10	3/8	12.5	3/8	5	7	14	8202 1183 34
HM OPEN 12-10	10	Rubber	12.5	1/2	12.5	1/2	13	22	12	8202 1183 35
HM OPEN 12-15	15	Rubber	12.5	1/2	12.5	1/2	11	17	13	8202 1183 36

Pivoting wall brackets needs to be ordered separately.

Dimensions

Flow chart

HM Open 12-10 (12-15)

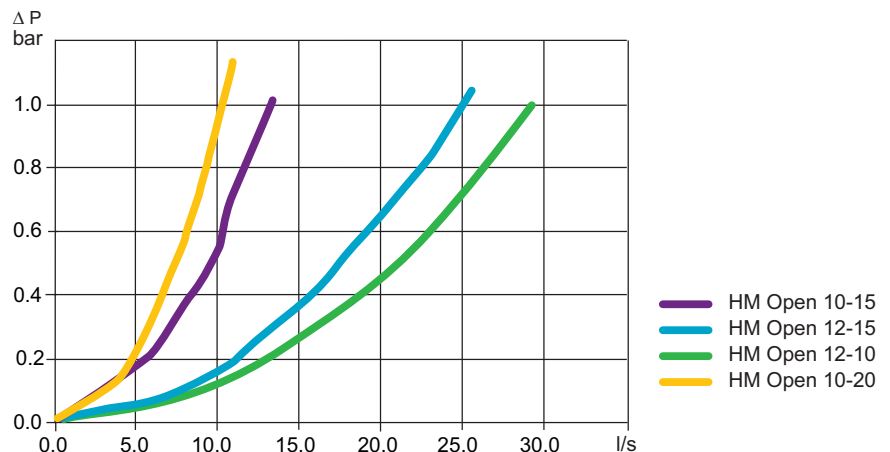
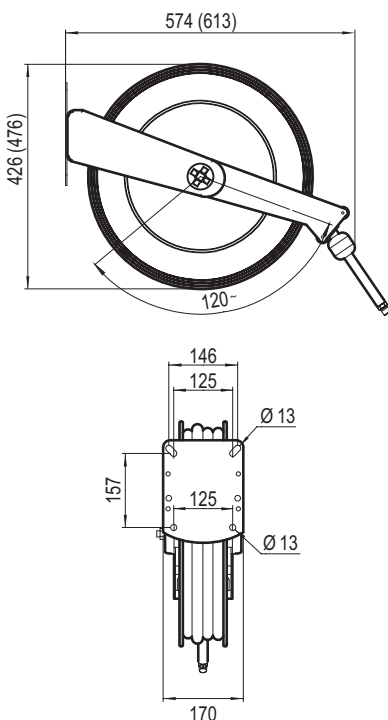

Accessories

	Ordering No.
Pivoting wall bracket	4390 2080 10

Hose Reels

HM Open XL

HM OPEN XL

Hose reels in the HM Open XL series have an open die cast aluminium casing and 3/8" or 1/2" hose. HM Open XL hose reels are recommended for screwdrivers, impact wrenches, pulse tools, drills, chipping and riveting hammers and high powered grinders.

- Spatter resistant rubber hose.
- Floor, wall or ceiling mounting.
- Revolving hinge for flexible use.
- Working temperature: -10°C - +60°C.
- Max working pressure: 15 bar.
- Inlet hose length: 1 m.



Model	Hose length m	Hose type	Hose inside dia		Connection inlet	Connection distribution hose BSP	Economical air flow (at 0.2 bar pressure drop) l/s	Max air flow capacity (at 0.5 bar pressure drop) l/s	Weight kg	Ordering No.
			mm	in	hose inside dia (cut of hose) mm					
HM OPEN XL 12-20	20	Rubber	12.5	1/2	12.5	1/2	8	14	27	8202 1183 37
HM OPEN XL 12-30	30	Rubber	12.5	1/2	12.5	1/2	8	12	28	8202 1183 38
HM OPEN XL 19-15	15	Rubber	19	3/4	19	3/4	27	44	28	8202 1183 39
HM OPEN XL 25-10	10	Rubber	25	1	25	1	60	95	30	8202 1183 40

Pivoting wall brackets needs to be ordered separately.

Dimensions

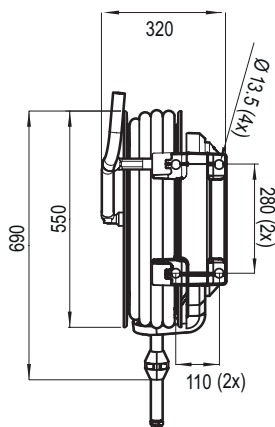
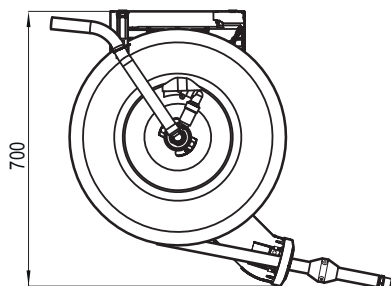

Flow chart

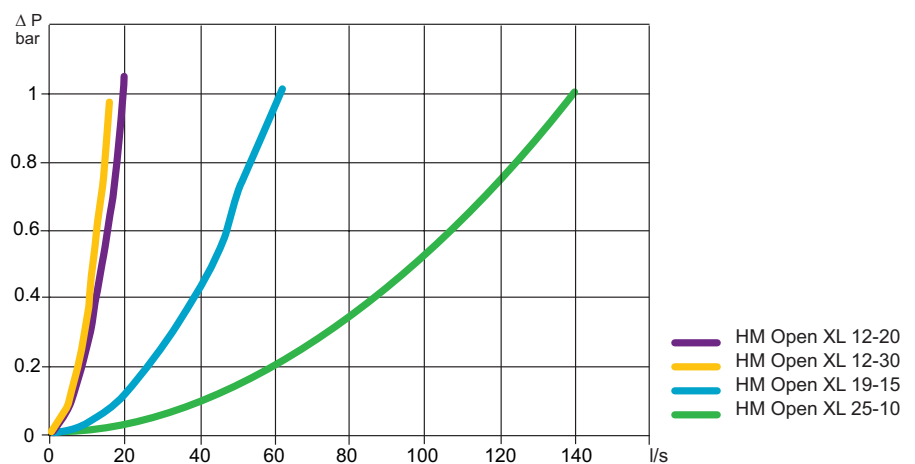

Accessories

	Ordering No.
Pivoting wall bracket	4390 2080 11

Hose Reels

HM Flex L

HM FLEX L

The HM FLEX L, with a steel casing and high quality rubber hose, handles both air and water. The HM FLEX L is recommended for all screwdrivers, pulse tools, impact wrenches, drills, chipping and riveting hammers and grinders up to 1000 W.

- NBR rubber hose.
- Movable brackets for floor, wall and ceiling mounting.
- High flow capacity.
- Working temperature: -30°C - +60°C.
- Max working pressure is 15 bar.
- Inlet hose length: 1 m.



Model	Length m	Hose	Hose inside dia		Connection inlet BSP male	Connection distribution hose BSP male		Air flow l/s	Weight kg	Ordering No.
			mm	in						
HM FLEX L	10	Rubber	12.5	1/2	1/2	1/2	22	16	8202 1181 56	

Dimensions

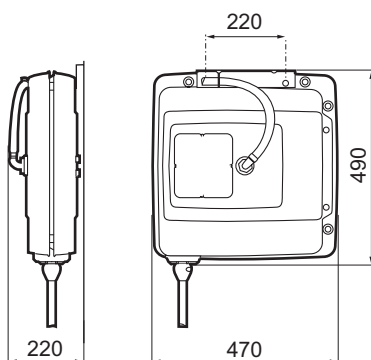



G2621
Ratchet Wrench

BRING A CENTURY OF EXPERIENCE TO YOUR PROJECT

Blow Guns

BG-series

Blow Gun BG-series

Atlas Copco blow guns BG-series are hard wearing, user friendly solution for all cleaning applications. The plastic body offer flexibility in handling for both left and right handed users, it insulate against cold and it reduce the risk of scratches to worksurfaces. The blow gun has excellent throtteling properties allowing easy regulation of the air flow. The blow guns have air inlet thread in brass that is fully covered by the plastic body. Two versions available with star tip to reduce risk of damages or injuries if the tube is pressed against workpiece or skin.



- High flow capacity.
- Suspension.
- Plastic body to avoid scratches.
- Air inlet thread in brass.
- Star tip availability for improved safety.
- Complies with OSHA STD1-13.1 and OSHA 1910.95.

Model	Version	Working pressure bar	Air flow l/s	Weight		Air inlet thread BSP	Ordering No.
				kg	lb		
BG 2603-HF	Long tube, high flow	6.3	7.5	0.13	0.29	1/4	8202 1006 04
BG 2604-SHF	Short tube	6.3	4.3	0.12	0.26	1/4	8202 1006 05
BG 2605-STSS	Short tube, star tip	6.3	6.6	0.12	0.26	1/4	8202 1006 06
BG 2606-ST	Long tube, star tip, silencer	6.3	6.3	0.14	0.31	1/4	8202 1006 07

Test Equipment

PRESSURE CONTROL UNIT

The unit consists of a high quality pressure gauge and the necessary couplings for checking the air pressure at the air inlet of the machine.

Ordering No. 4145 0699 81.

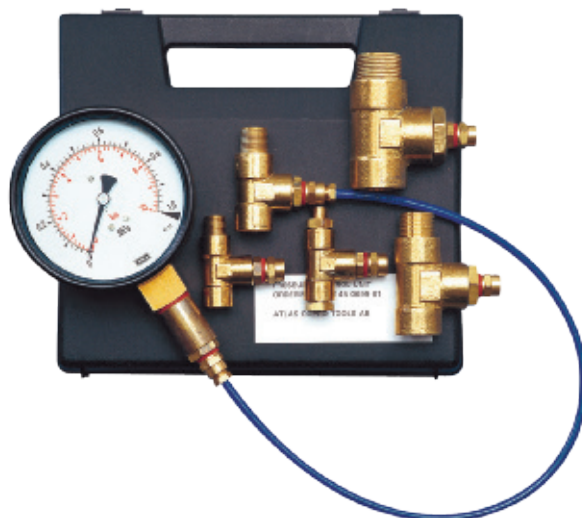

All local safety regulations with respect to installation, operation and overhaul must always be followed. Please read the separate instructions regarding safety which are supplied with all products in order to improve your own safety!

Ball valve

- Switch off the compressed air with the ball valve when you are not working (see fig. 1).
- Open all ball valves gently in order to discover improperly tightened devices (see fig. 5).

Air preparation units

- Please check for solvents which change the structure of polycarbonate bowls.

These solvents make the polycarbonate brittle so it can break. Normally polycarbonate is not easy to break. If you need to use aggressive solvents, please contact us and we will help you choose the right equipment.

- Use bowl guard.

An easy way to eliminate this type of accident is to use a bowl guard on MINI and MIDI units. The MAXI unit has an aluminum bowl with a new, more chemical resistant plastic on the inside as standard.

Check that the bowls are properly tightened and that all units are fitted together before switching on the compressed air with the ball valve.

Quick safety couplings

To increase safety and reduce the risk of operator injuries we recommend you to always buy couplings with a safety function. Couplings with a safety function are disconnected in two stages in order to vent the coupling and minimize the risk of sudden component separation, which has the potential to cause operator injury.

Never open a quick coupling with a screwdriver in order to ventilate the air.

Claw couplings

- Be very careful (see fig. 1+2+3).

They are always open and must be used very carefully. To increase safety when using claw couplings, we recommend the claw LNH claw coupling with a lock nut.

Clamps and connections

- Avoid screwdrivers when tightening.

Check that they are properly tightened. Avoid screwdrivers when tightening, they can easily slip and damage your hand. Use a wrench. If you need to use a screwdriver, mount the clamp in a vice.

Hoses

When mounting hoses on hose connections, use water and soap in order to make the hose slip on to the connection. Do not use oil. Water and soap will dry up. Remove leaking hoses. A small leakage can quickly become a large hole.

Blow guns

- Use the safety version. It eliminates the risk of air at high pressure coming into direct contact with skin.

^a Polycarbonate has good chemical resistance to all solvents except chemicals containing acetone, benzol, glycerine, some hydraulic and synthetic oils, chloroform, methyl alcohol, carbon tetrachloride (and similar solvents), carbon disulphide, perchloroethylene, toluene, trichloroethylene, xylene (nitrocellulose, thinner), acetic acid.

Follow this order when working with claw couplings:

1 How to open a claw coupling:

Close the ball valve.



2 Run the tool so the air ventilates out.



3 Release the claw coupling.



4 How to close a claw coupling:

Make sure that the two claw couplings are mounted together.

Use claw couplings with lock nut (LNH) or use a lock spring for safer locking.



5 Open the ball valve gently.



Vibration and Sound values

Model	Vibration total value (3 axes value) according to ISO 28927-2 Valid from 2010		Sound pressure levels and sound power levels ^a according to ISO 15744	
	Value 3-axes m/s ²	Uncertainty m/s ²	Sound pressure dB(A)	Sound power dB(A)
Impact Wrenches				
W2910	3.3	0.8	100	89
W2911	5.1	0.9	103	92
W2915	7.5	1.8	107	96
W2920	10.2	1.5	107	96
W2410	7	2.8	99	88
W2411	7	2.8	99	88
W2412	5.6	1	99	88
W2415	3.8	0.8	101	89.7
W2420	9.7	1.3	105	94
W2425	11.7	7	106	95
W2427	16.2	3.2	105	94
W2428	10.7	5.9	109	98

Model	Vibration total value (3 axes value) according to ISO 28927-2 Valid from 2010		Sound pressure levels and sound power levels ^a according to ISO 15744	
	Value 3-axes m/s ²	Uncertainty m/s ²	Sound pressure dB(A)	Sound power dB(A)
Ratchet Wrenches				
W2630	10.5	6.8	86	97
W2631	10.5	6.8	86	97
W2620	15	5.1	87	98
W2621	15	5.1	87	98
W2610	8.8	6.8	85	96
W2611	8.8	6.8	85	96

Model	Vibration total value (3 axes value) according to ISO 28927-2 Valid from 2010		Sound pressure levels and sound power levels ^a according to ISO 15744	
	Value 3-axes m/s ²	Uncertainty m/s ²	Sound pressure dB(A)	Sound power dB(A)
Screwdrivers				
S2305	<2.5	-	83	94
S2326	<2.5	-	83	94
S2308-C	<2.5	-	82	93
S2309-C	<2.5	-	85	96
S2310-C	<2.5	-	81	92
S2340-C	<2.5	-	83	94
S2360-C	<2.5	-	76	-
S2370-C	<2.5	-	83	94
S2450-P	<2.5	-	78	89
S2451-P	<2.5	-	78	89
S2452-P	<2.5	-	78	89
S2416-L	<2.5	-	73	-
S2426-L	<2.5	-	73	-
S2428-L	<2.5	-	70	-
S2480	6.4	1.2	90	101
S2481	6.4	0.9	89	100

Model	Vibration total value (3 axes value) according to ISO 28927-5 Valid from 2010		Sound pressure levels and sound power levels ^a according to ISO 15744	
	Value 3-axes m/s ²	Uncertainty m/s ²	Sound pressure dB(A)	Sound power dB(A)
Drills				
D2112	<2.5	-	80	91
D2116	<2.5	-	82	93
D2121	2.5	1.2	87	98
D2148-R	3.7	1.2	85	96
D2160	<2.5	-	80	91
D2163	<2.5	-	78	89
D2112Q	<2.5	-	80	91
D2116Q	<2.5	-	82	93
D2121Q	2.5	1.2	87	98
D2148-RQ	3.7	1.2	85	96
D2160-Q	<2.5	-	80	91
D2163-Q	<2.5	-	78	89

^a The uncertainty in the sound levels is 3 dB(A).

Additional information about the tests, vibration control and regarding in-use vibrations can be found at the link, www.atlascopco/PRO

Model	Vibration total value (3 axes value) according to ISO 28927-1 Valid from 2010		Sound pressure levels and sound power levels ^a according to ISO 15744	
	Value 3-axes m/s ²	Uncertainty m/s ²	Sound pressure dB(A)	Sound power dB(A)
Grinders				
Vertical grinder				
G2415	5.9	1.9	84	95
G2416	<2.5	-	80	91
Angle grinder				
G2515	6	2	83	94
G2510-US-4 ^a	6.9	2.3	81	92
G2510-US-4.5 ^a	7.9	2.6	78	89
G2408-100	6.4	2.1	81	92
G2408-115	8.1	2.7	81	92
G2408-125	10	3.3	81	92
G2511-125	6.5	2.2	84	95
G2511-115	5.9	1.9	81	92
G2511-100	5.8	1.9	79	90
G2588-S066	4.1	0.8	90	101
G2588-230-M14	7.8	2.6	90	101
G2588-7-US	7.5	2.5	90	101
G2588-5-US	8.1	2.7	90	101
G2588-180-072-M14	6.8	2.2	90	101
G2588-180-M14	7.1	2.4	90	101

Model	Vibration total value (3 axes value) according to ISO 28927-12 Valid from 2010		Sound pressure levels and sound power levels ^a according to ISO 15744	
	Value 3-axes m/s ²	Uncertainty m/s ²	Sound pressure dB(A)	Sound power dB(A)
Grinders				
Die grinder				
G2412-1	<2.5	-	79	90
G2440	<2.5	-	80	91
G2445	4.3	1	90	101
G2414-S085	<2.5	-	70	-
G2414-S120	<2.5	-	74	-
G2414-S150	2.5	0.7	76	-
G2414-S200	<2.5	-	81	92
G2414-S250	<2.5	-	85	96
G2414 S088-US	<2.5	-	71	-
G2414 S125-US	<2.5	-	74	-
G2414 S155-US	2.5	0.7	77	-
G2414 S205-US	<2.5	-	81	92
G2414 S255-US	<2.5	-	87	98
G2422-1	3.4	0.8	77	-
G2424-S085	5.3	1.2	<70	-
G2424-S120	<2.5	-	73	-
G2424-S150	<2.5	-	76	-
G2424-S200	<2.5	-	81	92
G2424-S250	3.5	0.8	85	96
G2424 S088-US	5.3	1.2	<70	-
G2424 S125-US	<2.5	-	73	-
G2424 S155-US	<2.5	-	76	-
G2424 S205-US	<2.5	-	81	92
G2424 S255-US	3.5	0.8	85	96
G2417-S250	<2.5	-	81	92
G2417-S180	4	0.9	74	-
G2417-S120	<2.5	-	<70	-
G2417-S250-US	<2.5	-	81	92
G2417-S180-US	4	0.9	74	-
G2417-S120-US	<2.5	-	<70	-
G2427-S250	<2.5	-	81	92
G2427-S180	3.8	1.9	74	-
G2427-S120	5.8	1.2	<70	-
G2427-S250-US	<2.5	-	81	92
G2427-S180-US	3.8	1.9	74	-
G2427-S120-US	5.8	1.2	<70	-
G2451	2.9	1.4	79	-

Model	Vibration total value (3 axes value) according to ISO 28927-8 Valid from 2010		Sound pressure levels and sound power levels ^a according to ISO 15744	
	Value 3-axes m/s ²	Uncertainty m/s ²	Sound pressure dB(A)	Sound power dB(A)
Saw				
C1050	14	2.3	78	89

Model	Vibration total value (3 axes value) according to ISO 28927-9 Valid from 2010		Sound pressure levels and sound power levels ^a according to ISO 15744	
	Value 3-axes m/s ²	Uncertainty m/s ²	Sound pressure dB(A)	Sound power dB(A)
Percussive				
P2520	17	3.2	78	-
P2540	3.4	0.8	83	94
P2541	3.1	0.8	85	96
P2550	5.3	1.7	83	94
P2551	6.7	2.8	85	96
P2505	5.6	1	72	-
P2530-H	12.5	4.8	96	107
P2530-R	12.5	4.8	96	107
P2531-H	11.5	4.7	100	107
P2531-R	11.5	4.7	100	107
P2535-H	-	-	103	114
P2535-R	-	-	103	114
P2536-H	-	-	103	114
P2539-H	-	-	102	113

Model	Vibration total value (3 axes value) according to ISO 28927-3 Valid from 2010		Sound pressure levels and sound power levels ^a according to ISO 15744	
	Value 3-axes m/s ²	Uncertainty m/s ²	Sound pressure dB(A)	Sound power dB(A)
Sanding and polishing				
G2588-S085-M14	2.8	0.7	90	101
G2588-S066-US	4.1	0.8	90	101
G2588-S085-US	4.2	0.8	90	101
G2410	<2.5	-	89	100
G2420	<2.5	-	83	94
G2302	<2.5	<2.5	81	92
G2502	<2.5	-	84	95
G2406	<2.5	-	79	-
G2407	<2.5	-	79	-
G2407M14	<2.5	-	79	-
G2438-6.3N	3.7	1.7	84	95
G2438-6.5N	10.5	4.5	85	96
G2438-6.10N	6.9	3.1	87	98
G2438-6.3I	3.7	1.7	84	95
G2438-6.5I	10.5	4.5	85	96
G2438-6.10I	6.9	3.1	87	98
G2438-6.3C	3.7	1.7	84	95
G2438-6.5C	10.5	4.5	85	96
G2438-6.10C	6.9	3.1	87	98
G2428	6.8	3.2	87	98

^aThe uncertainty in the sound levels is 3 dB(A).

Additional information about the tests, vibration control and regarding in-use vibrations can be found at the link, www.atlascopco.com/PRO

HOME OF INDUSTRIAL IDEAS - SERVING THE INDUSTRY SINCE 1873



G2511
Angle Grinder



G2588
Angle Grinder



W2920
Impact Wrench

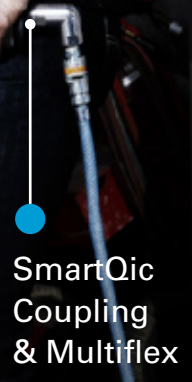

SmartQic
Coupling
& Multiflex

BRING A CENTURY OF EXPERIENCE TO YOUR PROJECT

