

Accessories Catalogue





GEKA ACCESSORIES

Since 1919, GEKA Group has been manufacturing Ironworkers for angle work, flats and profiles - for black iron, metal workshops, metal constructions, telecommunication and electrical towers and, generally all that is related with civil and industrial construction.

Many years of effort and work of studying and resolving problems and also years of continuous contact with clients: GEKA Group has a profound knowledge of the product, and this makes them different.

From their first ironworkers things have changed a lot. Market necessities, new technologies and improvement in metal production, have made GEKA Group adapt its machinery to new times. Like this, the first manually operated shears became mechanically operated, later hydraulically, and now these have a new version in automatic lines or CNC.

Geka offers more than 7,000 accessories to its clients. Standard accessories, optional accessories and special accessories. The standard accessories are integrated in the machines with the purchase. The optional ones can be bought easily and the special ones are specifically designed and made for the clients who order them.

Our versatility and continuous innovation allows us to continue being faithful to our goal of adapting to the needs of our customers.



01.

STANDARD ACCESSORIES

- 09. **Standard punching equipment**
- 10. **Standard rectangular notching equipment**
- 11. **Standard cutting of \varnothing and \sphericalangle**
- 12. **Standard cutting of L 90°**
- 13. **Standard cutting of flat bars**

Index

02.

OPTIONAL ACCESSORIES

- 16. T profile and Round and square bar cropping
- 16. U and I profile cutting
- 17. Hydraulic hold-down and extension module for angles and flats
- 18. Oversize punching unit up to diam 100 mm
- 18. Oversize punching unit up to diam 160 mm
- 19. Triangular notching
- 20. Claw notching
- 22. Pipe and Tube notching
- 22. Hydraulic hold-down for angles and flats
- 22. Rectangular notching for Microcrop
- 22. Punching unit UPN from 40 to 80 mm
- 22. Urethane stripper
- 22. Punching at the end of the tube
- 23. Manual Triple Punching Attachment
- 23. Flip Stop
- 23. Louvres notching
- 24. Standard press brake (in punching station)
- 24. Laser positioner
- 25. 2 position press brake:
Longitudinal and Transversal
- 25. Multistop table

03.

SPECIAL ACCESSORIES

- 28. Rounding and punching flattened pipes
- 28. Profiles punching
- 28. Punching oblong special L and U
- 28. Key notching in U
- 29. Multiple punching
- 29. Cut and punch of flat bars
- 29. Flower shaped punching
- 29. Shearing, notching and 2 punches
- 30. Flat bar rounding and punching
- 30. Double punching UPN
- 30. Punching + Emboss formed
- 30. Flat bars rounding / Straight cut + punching
- 31. Straight cutting + punching
- 31. Cut, notch and 2 punches
- 31. Urethane hold-down for Hydracrop
- 31. Urethane hold-down for Microcrop and Minicrop
- 32. Notching of louvres with no. 13 punch
- 32. Notching of louvers with hold-down
- 32. Notching of louvres
- 33. Chain shearing
- 33. Bars folding
- 33. Metal ring punching
- 34. Special notching per plan
- 34. Punching in the notching unit
- 34. Flat bar notching for T profiles
- 34. Rounding of flat bars in the notching unit

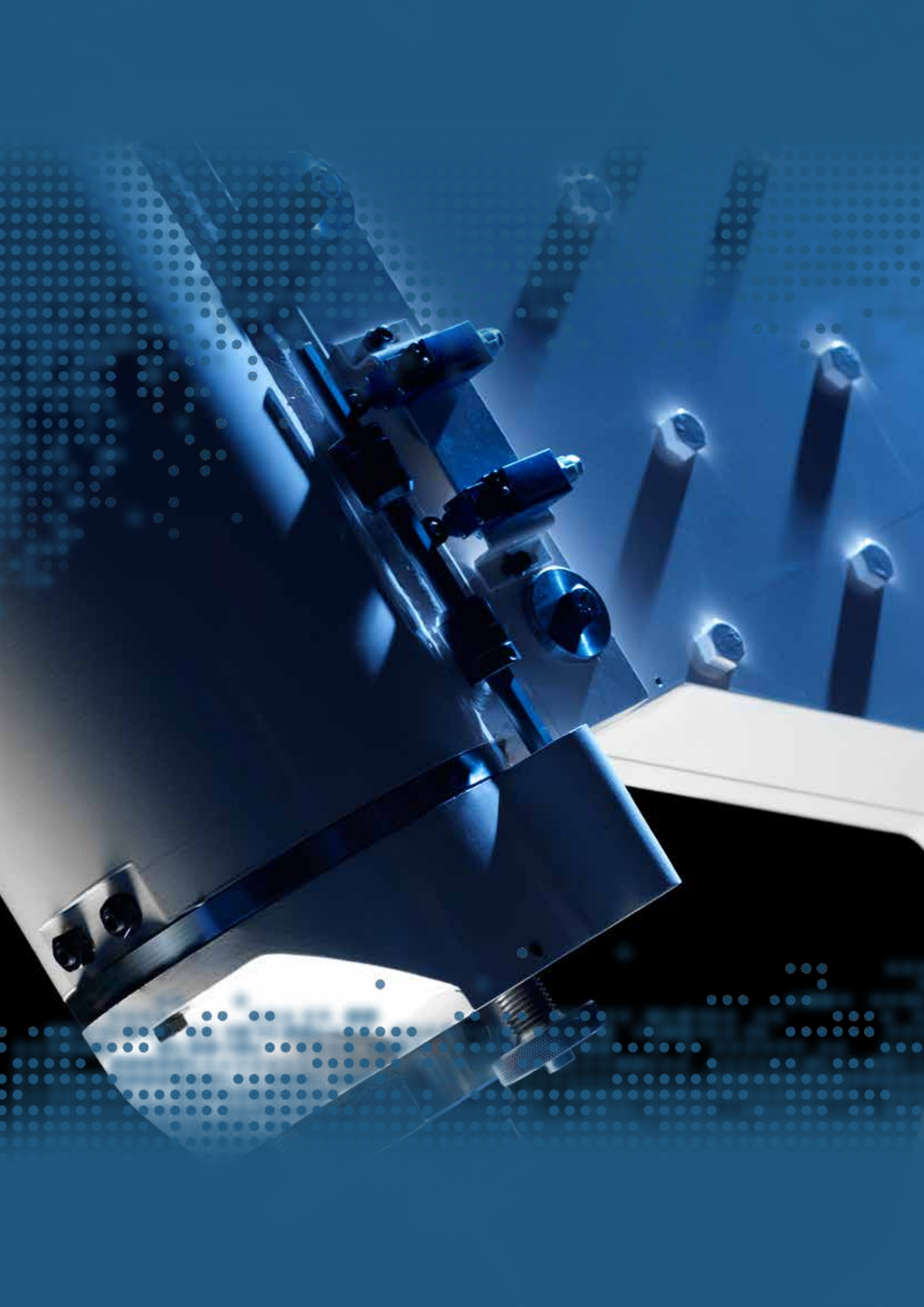

A blue-tinted photograph of a microscope, viewed from a low angle looking up. The image is overlaid with a grid of small, semi-transparent white dots. The microscope's components, including the eyepiece, objective lenses, and stage, are visible in various shades of blue and white.

01.

STANDARD ACCESSORIES

STANDARD ACCESSORIES



Geka currently has a complete range of over 7,000 personalized designs of accessories for special applications.

On many occasions, our users need to carry out special jobs, which do not fit in with any of the classical options of Conventional Ironworkers. For this reason, GEKA makes available to its users a team of engineers, with extensive experience in the development of all kinds of tools and special applications.



Microcrop standard punching equipment



Minicrop & Multicrop standard punching equipment



Hydracrop 55 standard punching equipment



Hydracrop 80 standard punching equipment

01

STANDARD PUNCHING EQUIPMENT



Hydracrop 110 standard punching equipment



Hydracrop 165 standard punching equipment



Hydracrop 220 standard punching equipment



Bendicrop standard punching equipment

Standard punching equipment

This equipment allows punching / forming in different materials using a punch and a die in the likeness of a press. The maximum capacity for each machine is given by the punching station power.

These values are expressed in Kilo Newtons or Metric Tons.

Machine	Punching Power	Maximum Capacity
Microcrop	360	Ø 27 x 10
Minicrop	450	Ø 27 x 13
Multicrop	450	Ø 27 x 13
Bendicrop	500	Ø 31 x 12 Ø 28 x 13
Hydracrop 55/110	550	Ø 40 x 10 Ø 20 x 20
Hydracrop 80/150	800	Ø 40 x 14 Ø 24 x 24
Hydracrop 110/180	1100	Ø 40 x 20 Ø 28 x 28
Hydracrop 165/300	1650	Ø 40 x 30 Ø 34 x 34
Hydracrop 220/300	2200	Ø 40 x 40 Ø 40 x 40

*Capacities based on material resistance of 45 Kg/mm²

NOTCHING STATION

Standard rectangular notching equipment

This accessory allows obtaining rectangular cuts on the outer perimeter of a sheet or profiles.
(Open notches)

The maximum capacity for this equipment is:

Machine	Width	Lenght	Material Thikness
Minicrop	40	50	7
Multicrop	40	50	7
Bendicrop	42	90	10
Hydracrop 55/110	42	90	10
Hydracrop 80/150	52	90	12
Hydracrop 110/180	52	90	13
Hydracrop 165/300	58	110	16
Hydracrop 220/300	58	110	16

*Capacities based on material resistance of 45 Kg/mm²

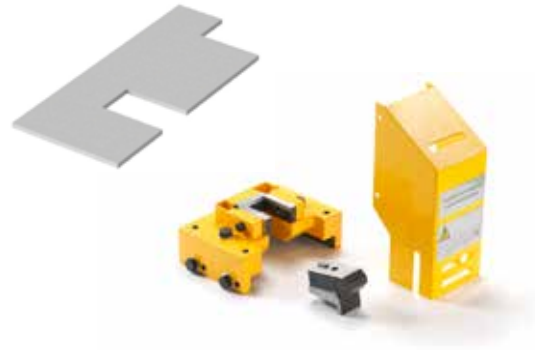

Minicrop & Multicrop standard rectangular notching equipment



Hydracrop 55 standard rectangular notching equipment



Hydracrop 80 & 110 standard rectangular notching equipment



Hydracrop 165 & 220 standard rectangular notching equipment



Bendicrop standard rectangular notching equipment

01

CUTTING STATION OF \varnothing AND \square Hydracrop standard cutting of \varnothing and \square 

Standard cutting of \varnothing and \square

This station allows cutting round and square bars.

Each type of machine has a different capacity for the maximum size of round and square bars.

These capacities are shown in the following table.

Machine	Round bar	Square bar
Microcrop	35	30
Minicrop	30	30
Multicrop	25	22
Bendicrop 50	35	30
Bendicrop 85	45	40
Hydracrop 55	40	40
Hydracrop 80	45	45
Hydracrop 110	50	50
Hydracrop 165	60	60
Hydracrop 220	60	60

*Capacities based on material resistance of 45 Kg/mm²

Multicrop standard cutting of \varnothing and \square Bendicrop standard cutting of \varnothing and \square Minicrop standard cutting of \varnothing and \square Microcrop standard cutting of \varnothing and \square

This station allows, under special design cutting other bars, several profiles and various combinations.

L CUTTING STATION

Standard cutting of L 90°

This equipment allows cutting L profiles at 90 °. In some models, such equipment can excel at 45° mitering.

The capacities are as following ones for shearing WITHOUT deformation:

Machine	Capacity	Excel
Microcrop	80 x 80 x 8	50
Minicrop	80 x 80 x 8	No
Multicrop	80 x 80 x 8	60
Bendicrop	80 x 80 x 8	No
Hydracrop 55	120 x 120 x 10	70
Hydracrop 80	130 x 130 x 13	70
Hydracrop 110	152 x 152 x 13	70
Hydracrop 165	205 x 205 x 18	70
Hydracrop 220	205 x 205 x 18	70

There is a possibility of shearing in larger profiles but with a slight deformation.

The capacities of these profiles are shown in the following table.

Machine	Capacity
Microcrop	-
Minicrop	100 x 100 x 10
Multicrop	-
Bendicrop	-
Hydracrop 55	130 x 130 x 13
Hydracrop 80	152 x 152 x 13
Hydracrop 110	160 x 160 x 16
Hydracrop 165	205 x 205 x 25
Hydracrop 220	205 x 205 x 25



Multicrop standard cutting of L



Minicrop standard cutting of L



Bendicrop standard cutting of L

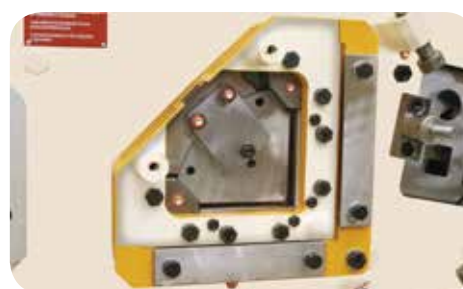

Hydracrop standard cutting of L

01

FLAT BARS CUTTING STATION

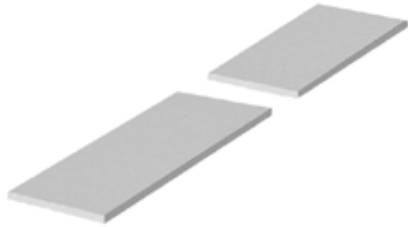

Standard cutting of flat bars

The cutting of the flat bars station is simple, and without any material waste.



Minicrop standard cutting of flat bars

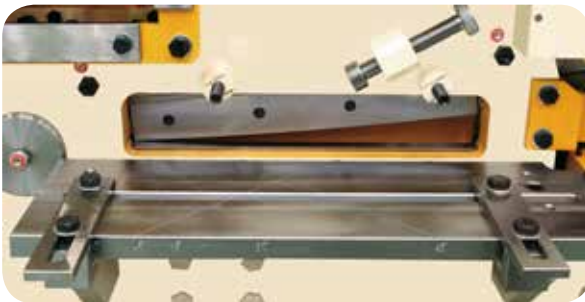

Hydracrop standard cutting of flat bars



Bendicrop standard cutting of flat bars

Machine	Capacity
Microcrop	350 x 6 mm 200 x 13 mm
Minicrop	300 x 10 mm 200 x 13 mm
Multicrop	300 x 10 mm 200 x 13 mm
Bendicrop 50	350 x 10 mm 350 x 15 mm
Bendicrop 85 SD	450 x 15 mm 450 x 18 mm
Hydracrop 55	300 x 15 mm 200 x 20 mm
Hydracrop 80	450 x 15 mm 300 x 20 mm
Hydracrop 110	600 x 15 mm 400 x 20 mm
Hydracrop 165	750 x 20 mm 400 x 30 mm
Hydracrop 220	750 x 20 mm 400 x 30 mm

*Capacities based on material resistance of 45 Kg/mm²



02.

OPTIONAL ACCESSORIES

OPTIONAL ACCESSORIES

GEKA has a wide range of optional accessories that are easily installed, for the punching, cutting and notching stations that will allow you to increase your production levels and shorten your delivery deadlines.

These accessories, available in stock, provide our customers with a fast and economical solution to their needs. Our philosophy is to cover the production needs of our customers with the best quality and in the fastest time possible.

U and I profile cutting

Another common combination in this station is the cutting of U and I profiles. Different combinations may also be obtained after close study.

The following table gives the maximum dimension of the profile U and I.

Machine	U & I cutting capacity	T cutting capacity
Microcrop	till 50 mm	50 mm
Minicrop	till 100 mm	100 mm
Multicrop	till 100 mm	100 mm
Bendicrop 50	till 100 mm	100 mm
Benicrop 85	till 120 mm	100 mm
Hydracrop 55	till 120 mm for U till 100 for I	80 mm
Hydracrop 80	till 140 mm	80 mm
Hydracrop 110	till 160 mm	100 mm
Hydracrop 165	till 180 mm	120 mm
Hydracrop 220	till 180 mm	120 mm

*Capacities based on material resistance of 45 Kg/mm²



02

OPTIONAL ACCESSORIES



T profile cutting & Round and square bar cropping

After study, you can get multiple combinations; the limitation is given by the shearing tonnage necessary or resulting sections in each combination.

A common combination is in T profile, bars. The table indicates the maximum T profile can be sheared on each machine model. The blades are easily changeable from one set to another.



Hydraulic hold-down

Hydraulic hold-down and extension module for angles and flats

Common element for all machine models. This tool allows us to make cuts of equal length automatically. You can lead all machine stations (profiles, carved, tires ...)

The base module can cut up to a meter or not doing repetitive work.

You can add quick connect extension modules, expandable meter by meter, needing support for these extensions.



Extension module

PUNCHING STATION

Oversize punching unit up to 100 mm in Diameter

This equipment allows obtaining the cut of geometric figures on flat surfaces. The punch must have the desired shape and figure which should circumscribe up to a diameter of 100 mm. The die must have the same shape with proportional set to the thickness of the material.

The table provides the maximum in thickness to be punched or maximum perimeter values by corresponding thickness.

Machine	Ø x max. thickness	Ø max. x thickness
Microcrop 36	Ø 17 x 16	Ø 38 x 8
Minicrop / Multicrop	Ø 18 x 18	Ø 100 x 4
Bendicrop 50	Ø 19 x 19	Ø 100 x 4
Bendicrop 85	Ø 24 x 24	Ø 100 x 6
Hydracrop 55	Ø 20 x 20	Ø 100 x 4
Hydracrop 80	Ø 24 x 24	Ø 100 x 6
Hydracrop 110	Ø 29 x 29	Ø 100 x 8
Hydracrop 165	Ø 34 x 34	Ø 100 x 12
Hydracrop 220	Ø 40 x 40	Ø 100 x 16
L50	Ø 20 x 20	Ø 40 x 9
L50P	Ø 20 x 20	Ø 50 x 7
Puma 55	Ø 20 x 20	Ø 100 x 4
Puma 80	Ø 24 x 24	Ø 100 x 6
Puma 110	Ø 29 x 29	Ø 100 x 8
Puma 165	Ø 34 x 34	Ø 100 x 12
Puma 220	Ø 40 x 40	Ø 100 x 16

*Capacities based on material resistance of 45 Kg/mm²

Oversize punching unit up to 160 mm in Diameter

This punch allows punching from Ø 3 mm to Ø 160 mm and or figures of various shapes: round, square, rectangular, slotted, hexagonal ... circumscribed in its various punches and dies.

The equipment is composed of different punches- and dies adapters for each tool in order to achieve an optimal position.

The punches can have in their cutting zone an angular termination, ie not completely flat or perpendicular to the motion. Achieving thereby a better cutting, reducing stress and increasing the cutting section.



Microcrop oversized punching unit



Bendicrop & Multicrop oversized punching unit



Hydracrop 55 oversized punching unit



Hydracrop 165 oversized punching unit

02

NOTCHING STATION



Microcrop triangular notching



Minicrop & Multicrop triangular notching



Hydracrop 55 triangular notching



Hydracrop 80 triangular notching



Hydracrop 110 triangular notching

Triangular notching

The notching is formed by a moving upper blade and two lower blades fixed to a lower die base. This accessory makes notches at 90°.

Machine	L x L x e
Microcrop	80x80x8
Minicrop	80x80x7
Multicrop	80x80x7
Bendicrop 50	100x100x10
Bendicrop 85	130x130x12
Hydracrop 55	100x100x10
Hydracrop 80	130x130x12
Hydracrop 110	130x130x13
Hydracrop 165	155x155x16

*Capacities based on material resistance of 45 Kg/mm²

NOTCHING STATION

Claw equipment

This equipment allows opening the cut flat bars legs in a claw-shaped way (Separation in the cutted areas).

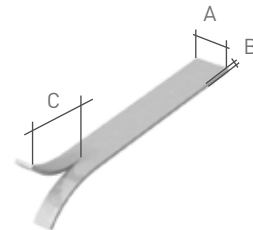

Machine	A	B	C
Microcrop	60	5	40
Minicrop	80	5	40
Multicrop	80	5	40
Bendicrop 50	50	6	43
Bendicrop 85	60	8	53
Hydracrop 55	50	6	43
Hydracrop 80	60	8	53
Hydracrop 110	60	8	53
Hydracrop 165	60	8	59

*Capacities based on material resistance of 45 Kg/mm²



Microcrop claw equipment



Minicrop claw equipment



Hydracrop 55 claw equipment



Hydracrop 80 & 100 claw equipment

02

NOTCHING STATION

Tube notching



Microcrop tube notching



Minicrop tube notching



Hydracrop 55 tube notching



Hydracrop 80 tube notching



Hydracrop 165 tube notching

This equipment allows notching tubes at 90 ° with equal or different diameters. The standard equipment is designed for tubes up to Ø 2".

This option is available in punching unit of the machine and has appropriate equipment.

In the Microcrop the tube notching is only available in the punching station.

ANGLES AND FLAT BARS SHEARING STATION

Hydraulic hold-down for angles and flat bars

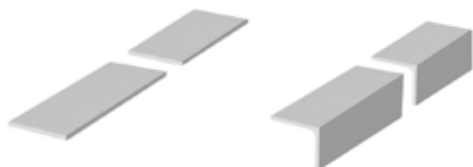

Este accesorio está disponible únicamente en la gama Hydracrop y ha de ser obligatoriamente montado desde GEKA en la máquina origen.

Tiene como objetivo la fijación de los perfiles angulares o llantas, mediante un mecanismo de accionamiento hidráulico. Dicho mecanismo presiona el material antes de ser cortado para evitar movimientos del material procesado. Una vez cortado el material el tope retrocede para permitir la entrada de nuevo material.

OPTIONAL ACCESSORIES

Rectangular notching – Microcrop

The rectangular notching is an optional accessory in the Microcrop.

The maximum capacities are the following ones: 36 mm of width, 53 mm length and 8 mm of thickness.



Punching unit UPN from 40 to 80 mm.

Substituting the lower base of the standard punching, this equipment allows punching in UPN from 40mm to 80mm in flanges and webs.

The maximum allowed diameter is 14mm. In rotating the die holder its design gives the possibility to use both options: flanges and webs

This equipment is only available for the range of Geka Hydracrop.

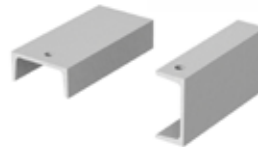

Urethane stripper

The urethane stripper attachment is designed to hold the flat material while being punched, in order to avoid deformation.

Designed and manufactured according to European regulations on safety.



Punching at the end of tube

This optional accessory allows punching at the ends of round or square tubes.

Square tubes up to 38 mm in diameter.

Round tubes up to 70 mm in diameter.

This accessory is only available for Hydracrop series.



02

OPTIONAL ACCESSORIES

Manual Triple Punching Attachment (Patented)



The optimum design of the triple manual punching attachment allows a precise and accurate selection of the needed tool without any error.

Flip Stop

It is a manually-adjustable mechanical stop unit to punch holes in a straight line.

The unit consists of a work surface, to be mounted on the machine, with 2 stops to control depth and one ruler, 2 metres long per module, which is mounted after the die holder, with 8 additional retractable stops per module.



Louvre Notching

The folding is to obtain a sheet metal part with straight edges and generatrices.

This unit of the Geka machines require, dismantling and clear the punching area. In this way we locate this useful tool to make this work.

This unit meets the European directives relevant to the manufacture of this type of industrial machines. In the European Union Geka sells only Bendicrop model.



PUNCHING STATION

Standard press brake

The folding is to obtain a sheet metal part with straight edges and generatrices.

This unit of the Geka machines require, dismantling and clear the punching area. In this way we locate this useful tool to make this work.

This unit meets the European directives relevant to the manufacture of this type of industrial machines. In the European Union Geka sells only Bendicrop model.

	Press brake power KN	Max. Capacity
Microcrop	360	80 x 12
Minicrop	450	80 x 14
Multicrop	450	80 x 14
Bendicrop	500	100 x 10
Hydracrop 55 S	550	500 x 3 300 x 10
Hydracrop 80 S	800	600 x 3 350 x 10
Hydracrop 110 S	800	700 x 3 400 x 10
Hydracrop 165 SD	1650	700 x 3 400 x 12
Hydracrop 220	2200	700 x 3 400 x 12



Minicrop & Multicrop standard press brake



Minicrop & Multicrop standard press brake

Laser positioner

This is an equipment with 2 linear lasers integrated in the punching Stripper. Both laser beams cross in the middle of the die-punch. Therefore, you can lay the piece easily just placing the punching point exactly where the lines cross.

The feeding is independent from the electric box. The lasers are fed by a Lithium battery (long lasting) which is integrated in the punching Stripper.

Because of this, to mount a laser positioning equipment in an ironworker, you only need to change the standard punching stripper by another with the laser equipment incorporated.



02

PUNCHING STATION

2 positions press brake: transversal and longitudinal



Longitudinal press brake

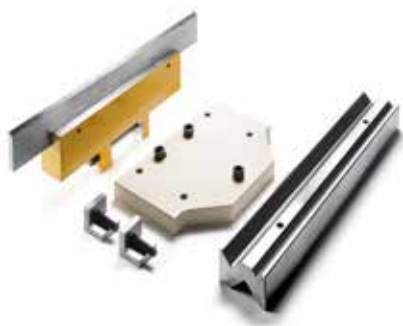

Transversal press brake

This folding operation, gives the possibility of placing the tool parallel and transversely to the machine. The throat deep conditions the length of the bend.

Designed and manufactured in accordance with European regulations on safety. The transversal brake is only available for models of Geka Hydracrop.

	L	W
Microcrop	80	12
Minicrop	80	14
Multicrop	80	14
Bendicrop	100	10
Hydracrop 55 S	300	6
Hydracrop 55 SD	500	6
Hydracrop 80 S	400	6
Hydracrop 80 SD	600	6
Hydracrop 110 S	400	6
Hydracrop 110 SD	700	6

Multistop table

This is a manual unit which is to be mounted on PUMA or Hydracrop SD machines with a minimum throat of 500 mm,

It has 5 retractable key stops mounted on a cross bar which slides of a guided arm.

The front part of the table can be removed for punching angles and channels. The stops can be moved approx. 500 mm from the middle of the die to the left and approx. 500 mm to the right. The depth capacity is approx. 350 mm. Adjustments are made manually on the millimeter scale, on the two axes.

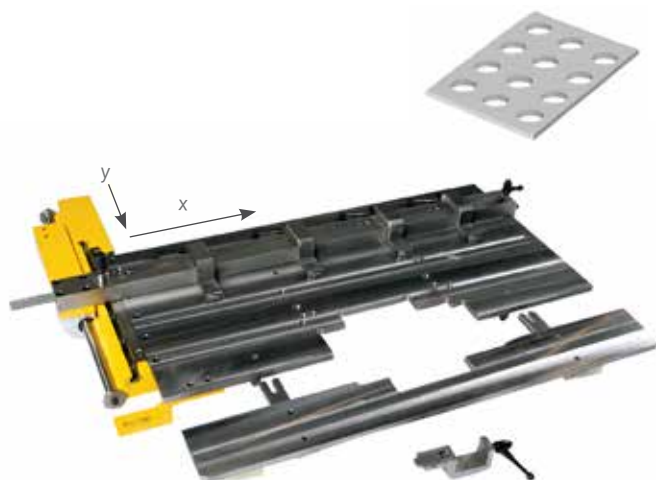



03.

SPECIAL ACCESSORIES



PUNCHING STATION

On many occasions, our users need to carry out special jobs, which do not fit in with any of the classical options of Conventional Punching Shears.

For this reason, GEKA makes available to its users a team of engineers, with extensive experience in the development of all kinds of tools and special applications.

Our versatility and continuous innovation allows us to continue being faithful to our goal of adapting to the needs of our customers.

Punching oblong special L and U

This option allows the client using extra-long punches, punching the inside of L and U profiles in an oblong way.



Key notching in U

This accessory allows the client using extra-long punches, punching the inside of U profiles in a Key-shaped way.



03

PUNCHING STATION

Multiple punching

The multiple punching of this equipment allows making different combinations of diameters and distances.

**Cut and punch of flat bars**

By simultaneous cutting and punching of the flat bar, we can obtain simple pieces of no big dimensions.

**Flower shaped punching**

It is possible to obtain simple and varied shapes by punching of the oversize punching units. It is useful for trellises, fences ...

**Shearing, notching and 2 punches**

Shearing and notching the flat bars is another possibility that can be made with the oversize punching units.



PUNCHING STATION

Flat bar rounding and punching

This tool allows rounding and punching flat bars at the same time.



Double punching UPN

This option allows making double punching in the webs of the profiles.



Punching + Emboss formed

Simple shapes can be punched and emboss form in only a stroke.



Flat bars rounding / straight cut + punching

Rounding, straight cut and punching at the ends of flat bars is another possibility that can be made with the over-size punching unit.



03

PUNCHING STATION

Straight cutting + punching

Flat bars can be punched and cut with a straight end.

**Cut, notch and 2 punches**

Flat bars can be punched twice and cut with a straight end.

**Urethane hold-down for Hydracrop**

The punching of multiple holes close to each other in flat bars causes deformations on these bars. This stripper corrects this deformation generated by the tension of punching.

**Urethane hold-down for Microcrop and Minicrop**

The punching of multiple holes close to each other in flat bars causes deformations on these bars. This stripper corrects this deformation generated by the tension of punching.



PUNCHING STATION

Rounding and punching of flattened pipes

Previously flattening the tube, this equipment allows rounding and punching their flattened ends.



Profiles punching

This option allows using extra-long punches and a stopper extractor, punching the inside different profiles.

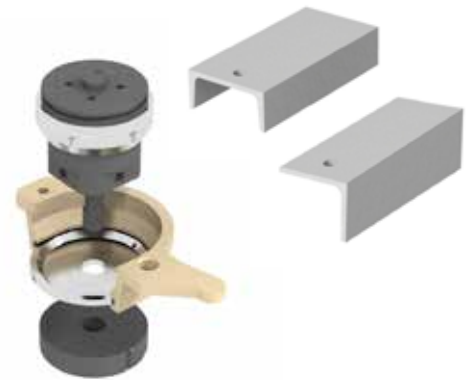

Notching of louvres with no. 13 punch

With the oversize punching unit, the customer can get louvers of different size in their material.



Notching of louvers with hold-down

With the oversize punching unit the customer can get louvers of different size in their material.

This option includes a hold-down to get a better finish.



03

PUNCHING STATION

**Notching of louvers**

With the oversize punching unit diameters the customer can get louvers of their material.

**Chain shearing**

A punch and a die with a triangular form, allow the client cutting chains.

**Bars folding**

One or more bars can be folded with this tool when adding this tool to the oversize punching unit.

**Metal ring punching**

Through a guided and double punching the client can obtain small sized washers.

NOTCHING STATION

Special notching per plan

The notching side of the machine allows different shapes as needed.

Punching in the notching unit

This tool allows us to punch in not very wide materials or in the edges of flat bars with large dimension.



Flat bar notching for T profiles

Some T profiles can be notched in the web and flanges after previous study.



Rounding of flat bars in the notching unit

This option allows rounding flat bars in the notching unit.



03



Should any of our registered accessories out what the customer is looking for, our technical department is at your disposal to develop the necessary accessory.







World leader in punching and shearing solutions

With more than 80000 happy and satisfied customers worldwide and more than 90 years experience.



Proven quality, design and craftsmanship

ISO 9001 and OHSAS certifications besides 90 years experience and a continuous benchmarking policy.



Complete after sales service

Permanent stock and next day delivery of consumables, accessories and parts. After sales assistance by GEKA's qualified engineers.



Great versatility

More than 50 different machine models and over 8000 different accessories. GEKA offers the highest range in accessories and optional equipment in the market.



Produced & manufactured in the European Union

Conversely other manufacturers, GEKA is the only ironworker fully produced by Geka in the UE.



Continuous innovation

New Bendicrop 85, C2PL, Alfa 500, Alfa 150...



Worldwide distribution network

With more than 60 distributors and present in more than 85 countries in 5 continents.



All GEKA machines are special order

Every new GEKA machine is one of a kind. Our designers develop solutions suited to your specific needs. We manufacture each GEKA in our own facilities according to precisely defined standards.



GEKA Worldwide

Know-how and market share characterize our GEKA success story since our humble beginnings almost a century ago. In the first ninety years, the GEKA Group has forged for itself a proven track record of excellence and performance.

- Over 80% of our production is exported
- Our global network consisting of 60 local distributors all over the world
- Worldwide sales in over 85 countries
- On-demand customer care offering superior service and maintenance

On any given day, more than 80,000 GEKA machines are pounding away on five different continents. Now that's customer satisfaction!





GEKA 
The steel working company

www.geka-group.com

Maquinaria Geka S.A. Polígono Zerradi, 1. P.O. Box 163. 20180 Oiartzun - Spain. T. +34 943 490 034. info@geka.es