

# MOTOMAN GP8

Handling & General Applications  
with the GP-series



The MOTOMAN GP8 is an extremely fast and precise 6-axis industrial robot with a payload capacity of up to 8 kg. With a reach of 727 mm and a high repeatability of  $\pm 0.02$  mm, it is ideally suited to assembly tasks, but also universal handling tasks, CNC machine tool tending or packaging. Its smooth, streamlined and award-winning modern industrial design is attractive and minimizes the space requirements at the installation site.

Cable entry is optionally from the side at the pedestal or from underneath through the base plate, thus enabling space-saving and uncluttered integration into its environment, irrespective of the intended installation position. The prepared routing of the supply lines in the arm enables optimal integration of the grippers or sensor systems, often dispensing with the need for an external media package.

A world of possibilities is open to the MOTOMAN GP8 with the numerous functions of the MOTOMAN YRC1000 controller or the compact MOTOMAN YRC1000micro controller. In conjunction with the conventional teach pendant, this robot is a reliable mechanical engineering partner. With the innovative operator control concept of the SmartPendant, it provides an excellent point of entry into the world of robotics.

As standard, the MOTOMAN GP8 is designed with the high protection classification IP67 (wrist). Other variants (e.g. with food-compatible grease in the food industry, special anti-corrosion coating for applications in aggressive ambient conditions, or as a cleanroom version) are optionally available.

## KEY BENEFITS

- Extremely fast and powerful
- Compact and flexible
- Large working range: 727 mm
- Reduced interference contours due to optimized design
- Simple commissioning and maintenance



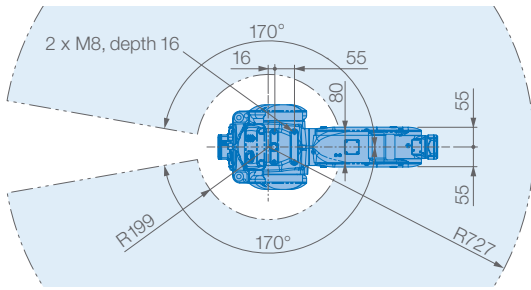
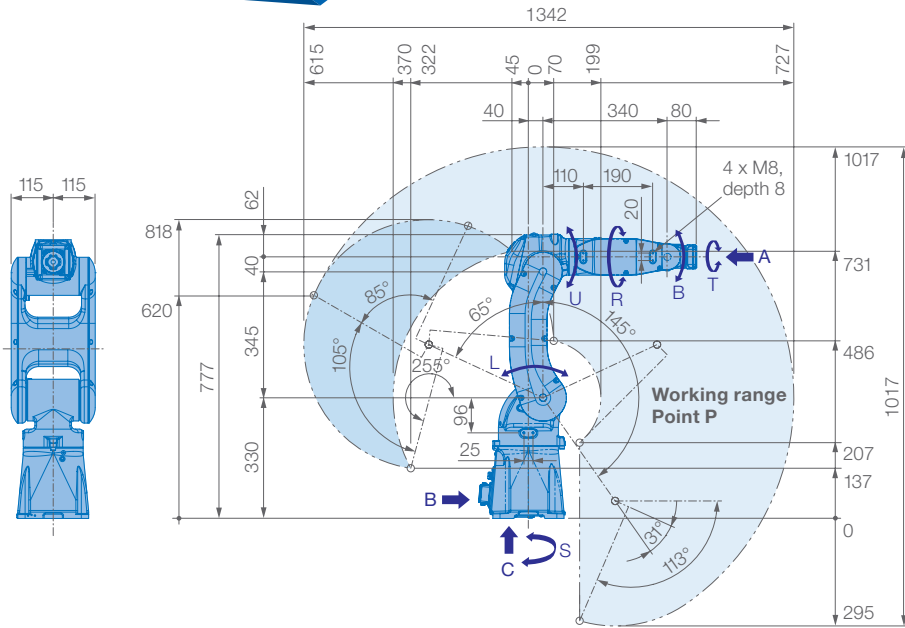

**Prevent interaction of the robot with:**

- Corrosive gases, liquids or explosive gases
- Exposure to water, oil or dust
- Excessive electrical noise (plasma)

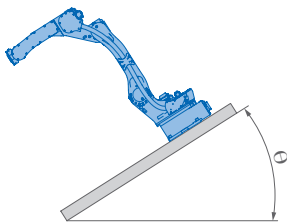

**Allowable wrist load**

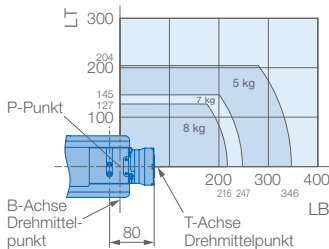

**View A**

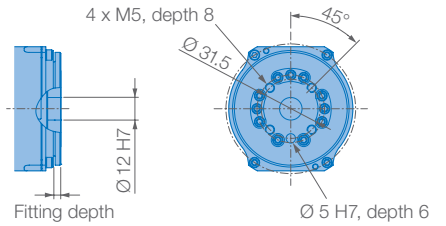

**View B**

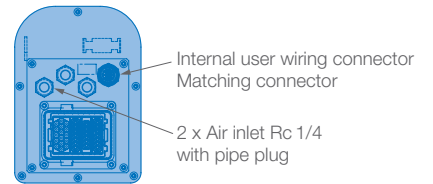

**View C**

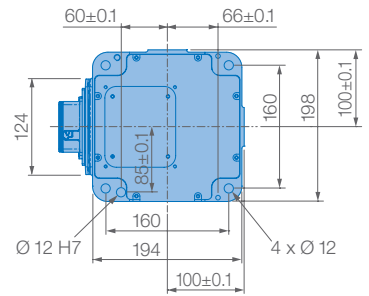

Mounting options: Floor, ceiling, wall, tilt\*

Schutzklasse: IP67

\* tilt with condition of angle – see table below

Robot installation angle $\theta$ [deg.]	S-axis operating range [deg.]
$0 \leq \theta \leq 30$	$\pm 170$ degrees or less (no limit)
$30 < \theta \leq 35$	$\pm 60$ degrees or less
$35 < \theta \leq 45$	$\pm 45$ degrees or less
$45 < \theta$	$\pm 30$ degrees or less

Specifications GP8					
Axes	Maximum motion range [°]	Maximum speed [°/sec.]	Allowable moment [Nm]	Allowable moment of inertia [kg · m <sup>2</sup> ]	Controlled axes
S	$\pm 170$	455	–	–	6
L	+145/–65	385	–	–	Max. payload [kg]
U	+190/–70	520	–	–	Repeatability [mm]
R	$\pm 190$	550	17	0.5	Max. working range R [mm]
B	$\pm 135$	550	17	0.5	Temperature [°C]
T	$\pm 360$	1000	10	0.2	Humidity [%]
					Weight [kg]
					Power supply, average [KVA]

\* Conforms to ISO 9283 \*\* Varies in accordance with applications and motion patterns Note: SI units are used for specifications

**YASKAWA Europe GmbH**

Robotics Division  
Yaskawastraße 1  
85391 Allershausen  
Germany

Tel. +49 (0) 8166 90-0  
robotics@yaskawa.eu.com  
www.yaskawa.eu.com

YR-1-06VX8-A00  
A-06-2019, A-No. 206022