



simasa

Excellence and reliability

Catalogue January 2018



Content

1 INTRODUCTION

Welcome to SIMA	6 - 7
45 years experience in designing and producing high-end machines	8 - 9
A flexible and efficient manufacturing process	10 - 11
Innovation	12 - 13
New concepts	14 - 15
Quality Assurance	16 - 17
After Sales Service	18 - 19
SIMA worldwide	20 - 21

2 REBAR PROCESSING

CEL Range	24 - 25
DEL Range	26 - 27
COMBI Range	28 - 29
STAR Range	30 - 31
SPIRAL Range	32 - 33
ACCESSORIES	34 - 35
TX 16	36
DM 12	36
C6	36
Blades	36
CX	37
ATA 450 Li	37

3 MASONRY SAWS FOR CONSTRUCTION MATERIALS

MAGNUM Range	40 - 41
BALI Mekano Range	42 - 43
DAKAR Mekano Range	44 - 45
VENUS Mekano Range	46 - 47
PERLANATO Range	48 - 49
EUROTRON 315 PLUS / 315 XL	50
AMBAR 200	51
MIX PRO 1600	51
VENUS 125 Polypanel	52
HANDY 350	53
HANSAFE	54 - 55
ACCESSORIES	56 - 57



4 PAVING TREATMENT

COBRA Pro Range	58 - 59
COBRA Mekano Range	60 - 61
COBRA 45/60 Range	62 - 63
TRENCHER 60/70 Range	64 - 65
HALCON Range	66 - 67
DRILL 9	68
RIG	68
B50 I / C50 IB	69
CAT 202	69
ACCESSORIES	70
The COBRA VARIO project	71



5 DIAMOND BLADES AND CORE DRILLS

Diamond blades Range	74 - 75
SIMA PLUS Range	76 - 79
SIMA PREMIUM Range	80 - 81
Core Bits	82 - 83



INTRODUCTION

- Welcome to SIMA
- 45 years experience
- Manufacturing process
- Innovation
- New concepts
- Quality Assurance
- After Sales Service
- SIMA worldwide

1





Welcome to SIMA

Born in Spain in the '70s, the brand **SIMA** has turned over the years into a reference in the light construction machinery industry in Europe.

With over 45 years of manufacturing experience, **SIMA** offers to the construction professionals a range of premium quality reliable machines, designed and made in Spain

Our international scope and continuous expansion has led **SIMA** to being present in more than 75 countries in the world.

A highly efficient After Sales Service adds to **SIMA** positioning as a safe and reliable partner to all our customers.

And we bet for the future. This is why **SIMA** begins making our future from the present. Our R&D department is fully committed to add innovation and improvement in all our machines range, to satisfy the ever changing and demanding needs of the evolving market.

We are a dynamic and flexible company. And we look forward to making **SIMA** the leading company in adaptability to our customers needs, through a perfect service and a highly innovative profile.

We consider our mission to produce high quality equipment, safe and efficient, becoming a reliable partner to our customers in their projects development.





Rebar Processing:

SIMA is side to side with those who work with rebar: be it cutting or bending, we have a complete range to match the most demanding professional needs.

Our rebar processing machines supply a high productivity both, on the construction sites and on the rebar workshops.

With an impressive and unbeatable durability, SIMA rebar machines will provide long shifts of efficient work on rebar processing for many years. Guaranteed by a rebar market leader.



Masonry Saws:

SIMA offers a wide range of table saws to deal with each different material, with fast, reliable and efficient solutions.

Their finishing quality, their high working performance and the robust design make them the perfect tool for all kind of cutting works and materials (masonry, tiles, bricks, natural stone, etc.) or wood, in the case of our circular site saw.



Paving Treatment:

The SIMA range contributes to the surface treatment in the different moments of this process: road or cutting or trench marking, concrete trowelling or scarifying on different surfaces.

A complete range of floor saws (including our exclusive model Trencher), Power trowells and Scarifiers, supplying our customers with what they may need. SIMA experience is a guarantee of endurance and reliability with a state of the art technology.



Blades and Core Drills:

The natural complement for our machines range are the diamond blades and the core drill bits, which necessarily stand up to SIMA machines quality.

They are manufactured with the perfect combination of metal bonds and diamonds of the right size and in the right proportion to ensure the best cutting and drilling for each material.

Experience and know how are the words that best define SIMA blades range.

45 years experience in designing and producing high-end machines

1970

Sociedad Industrial de Maquinaria Andaluza S.A. (SIMA) is created by Antonio García, upon his invention of the first 45° ceramic tiles cutter.



1981



The same inspiring principles lead the entrance of SIMA into the Rebar Process markets.

1990

SIMA starts addressing the pavement cutting segment, hence widening the range of solutions that the brand offered to constructors on the first stages of their works. Later, other pavement treatment machines will add to the range (power trowels, scarifiers, etc.)

1970

1980

1990

1970



Initially, the brand colours as shown on the machines is red and green. Ten years later these colours were replaced by cream and blue.



1979



Fully imbued with the conviction of offering those products that would best adapt to the market demands, new innovations keep expanding the range. So happened with what is considered to be the first wet cutting table saw in Spain, named... **EVA**.

1995



SIMA begins its international expansion, starting by the neighbouring mediterranean countries, and then towards Latin America.

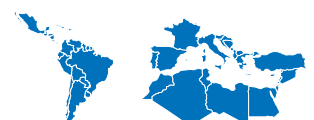

In **2018** SIMA is present in 77 countries and continues with its international development strategy, consolidating his current positioning and opening new markets.



1998



The Company owner creates PYLTIN, a subsidiary to laser cut, bend and paint the metal parts of SIMA machines. Later, PYLTIN also started supplying other companies besides SIMA.

2005

Until six years later, when they evolved to become the current corporate colours of SIMA brand and machines.



2007

SIMA premises reach their current size of 27.000 m².



2000



1999

Once more, SIMA supplies to the market demands. On this year SIMA creates the first wood cutting machine fully certified for safety standards and new white and blue corporate colours are briefly adopted.



2006



The former SIMA after sales service department evolves with the creation of independent technical workshops certified by SIMA. This net of certified official workshops became SERVISIMA.



2010

2008

The second generation of the family run company takes office in the company Management: Javier García is appointed new Managing Director of SIMA.



2015

SERVISIMA is now available in more than 70 service points worldwide.



A flexible and efficient manufacturing process

Currently **SIMA** facilities are totalling 27.000 m². In the manufacturing section **SIMA** develops the complex production process, from metal laser cutting and forming, robot assisted, to surface treatment and painting; from the electrical panels building to the assembly and packing of the finished products.

In the production process **SIMA** integrates a Lean Manufacturing system, including the stock management for a faster and effective response to our customer requests.

This system has being designed to follow a process protocol that allows only one possible solution for every manufacturing step, thus tending to a zero mistake level. The objective is achieving a maximum working efficiency with the least possible waste. This includes suppressing every redundant process whose cost shall not be charged on the products cost.



Why SIMA?

- ✓ A Spanish brand, made in Spain.
- ✓ Efficiency and flexibility to cope with the market and customers needs.
- ✓ 45 years manufacturing premium quality professional machines and tools.
- ✓ International stance, being present in 77 countries.
- ✓ Excellent world wide after sales assistance.

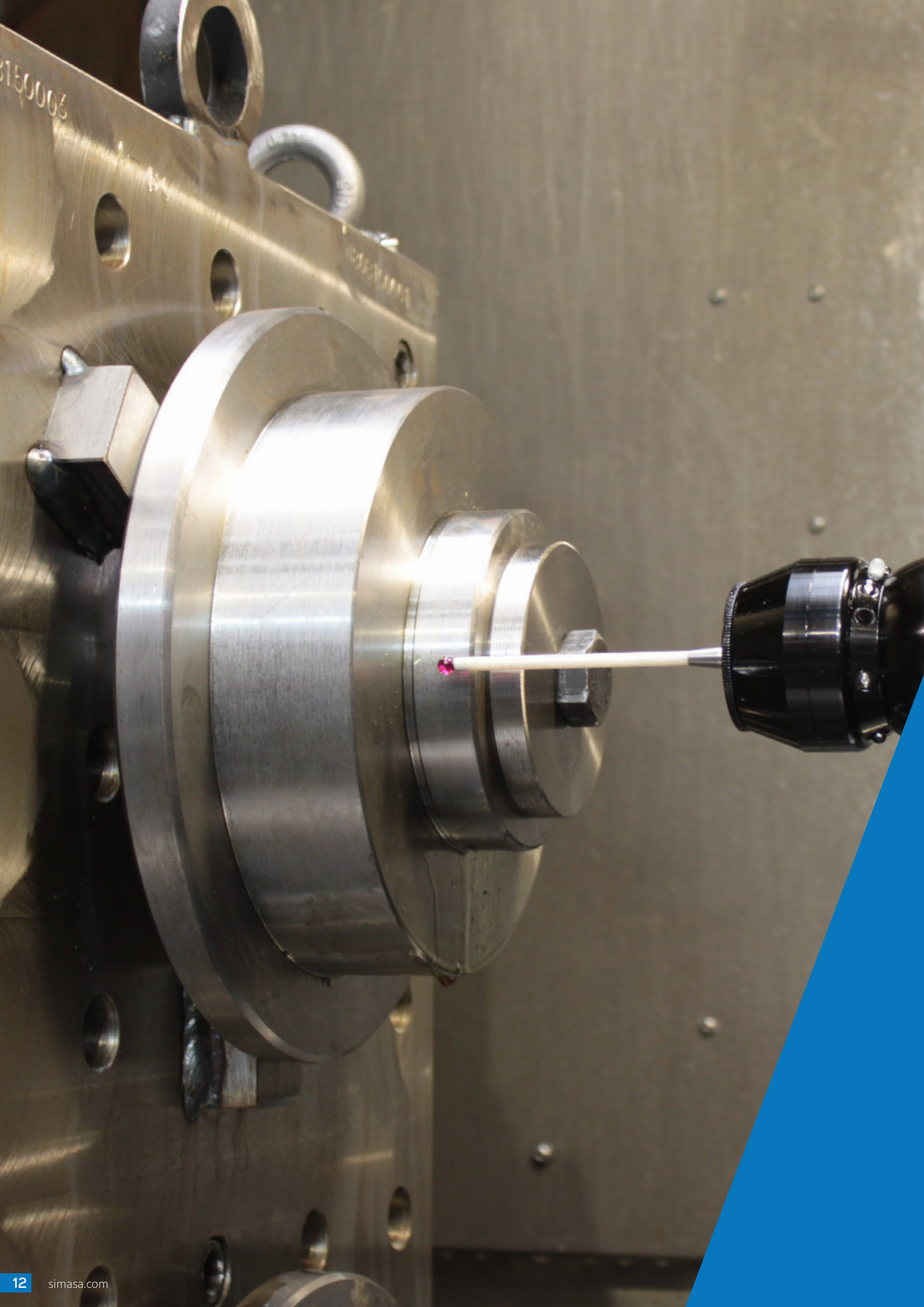

150006

Innovation

The Technical Development Office engineers are responsible for the designing, the blue prints and the technical specifications leading to the prototype construction. Some of the initial parts in the prototypes are 3 D printed.

Teaming up with them, specialized technicians focus on the prototype construction.

Later, the prototypes will be checked by the Technical Development Officers together with our Q.A. staff, and put to different tests, one of them a real work simulation performed by customers selected at random to that purpose.

Once all the test phases have been passed, the serial production starts. Innovation is deeply engraved in **SIMA** philosophy. We are conscious that there is no future without innovating.

As pioneering innovators we count on high precision technologies, such as inductive sensors in the rebar bending machines, or the air spring depth adjustment in the pavement cutters. New products are constantly developed using innovative materials, such as polymers, which are themselves produced in accordance with the environmental preservation regulations and safety at work norms.

The success of our new products is endorsed by our high customer satisfaction level... and by copycats performed by some of our competitors.

There is no secret to this success: as much as creativity is key to innovation, listening to our customer suggestions and needs is our fundamental source of inspiration.

Our R&D department is centre point to understand and provide technical solutions upon the information that reaches us from the market. Our team is permanently seeking new areas and methods to improvement and renovation, but it is only our customers who inspire our breakthroughs.

R&D is a team of experienced engineers, designers and technicians that use 3D state of the art calibrating and measuring equipment in **SIMA**'s laboratories. With this equipment **SIMA** team also service other companies under request.



Choose your own configuration for your table saw



New Concepts

Mekano concept

This is a very innovative concept, derived from our orientation to flexibility. It is based on the idea of using common parts for the different machine models, so our customer may just add or replace some of them to transform his **SIMA** machine into another more suitable for a different use.

Our ranges **BALI, DAKAR, VENUS** and **PERLANATO** are 100% configurable. 65% of their components are compatible for all models, which provides unmatched ease to change the configuration of any cutting table. Furthermore, it also means relevant savings for the end user, who can reshape his machine into other models by just changing some parts.

Motor, water tub, switch, blade guard, sliding cart and legs are the elements shared by any of the **Mekano** models.

Choose the length and cutting height; 90° or 45° cut, sliding cart or rail bridge.

There is a great marketing added value in this concept, since our customers may choose the different options to produce a tailor-made machine for their own end customers, fully adapted to their market demands.

Our aim is taking a step forward in our products improvement based on continuing innovation.



Poly panel concept

Insulating panels with a polyurethane core and metal coating on both sides (also known as Sandwich Panel) is becoming more and more common in construction, thanks to its insulating properties and its ruggedness. Its light weight makes it very easy to handle and install.

However, this material is not easy to cut with a power tool, as it is normally cut, due to its thickness and the size of the panels supplied by their manufacturers.

SIMA has adapted the two meters long cutting table **VENUS 200** for cutting Sandwich Panel. The adaptation involved changing the blade (a TCT blade instead of a diamond one), some safety elements, etc. This means building the first machine specifically designed to cut this material.



Vario concept

This concept is the evolution of the traditional pavement cutting machine. A Vario machine performs the classic single blade pavement cut, but it is also ready to reconfigure for cutting with more blades, with different cutting configurations, for example, two equidistant cuts from 2 cms. wide to 10 cm., or even bevel cuttings.

The **VARIO** concept responds to emerging needs, such as producing narrow trenches for laying optic fiber or tactile lines in train stations or airports for blind persons.



Handy concept

A market niche not sufficiently fulfilled is the need of a portable stationary dry cutting machine. Half way between the table saws and the small chop saws with a limited cutting capacity, our Handy stands out as a rugged but light weight machine, with an efficient dust collecting system (vacuum cleaner assisted), for masonry materials dry cutting.

This is our concept: a highly professional machine designed for powerful and accurate dry cutting with an efficient dust riddance system. It can be both used, with the sliding cart or as a chop saw, tilting the swinging head.



Double speed rebar benders

From our high performance rebar benders **DEL 32**, **DEL 36** and **DEL 45** SIMA has developed two speed versions that can be selected by just turning a switch.

This machines can bend rebar at normal speed. But in those cases where the rebar diameter allows a faster bending by just selecting the switch position to the second speed the operator will be able to double his working speed. It is the perfect solution to produce stirups, (by using the optional complementary accessory offered by **SIMA**), which can be bended at a higher speed due to its typically smaller diameter.

Quality Assurance

As the key to success in all machinery industry, Quality is inherent to **SIMA** approach. We do not endeavour but for the best quality.

To guarantee the best quality in all our machines, **SIMA** has developed an Q.A. inspection adapted to each model and covering all its components. All the different parts are subject to a measuring control to determine its compliance with the previously established parameters that will be tested prior to any product launch.

Each component production, either from external suppliers or **SIMA** manufactured is tested to conformity.

Finally, in the assembly process, a new Q.A. process takes place, where each machine is individually tested for calibration, and is started to verify that it works properly.

Besides the qualified in-factory tests for Q.A. continuous improvement, **SIMA** always undertakes the most convincing test available: the customer test. We take a trial on the machines in work sites or wherever the machine would be naturally used. The person who would typically use it is the one that will work with the prototype, and will suggest advantages and potential improvement according to his experience.

These suggestions will inspire the modification or approval of the machine before the serial production takes place.

Finally it is in **SIMA** stance to apply the Quality principles to all the company areas and members, from R&D and Production to the Purchase, Sales, Financial, etc.

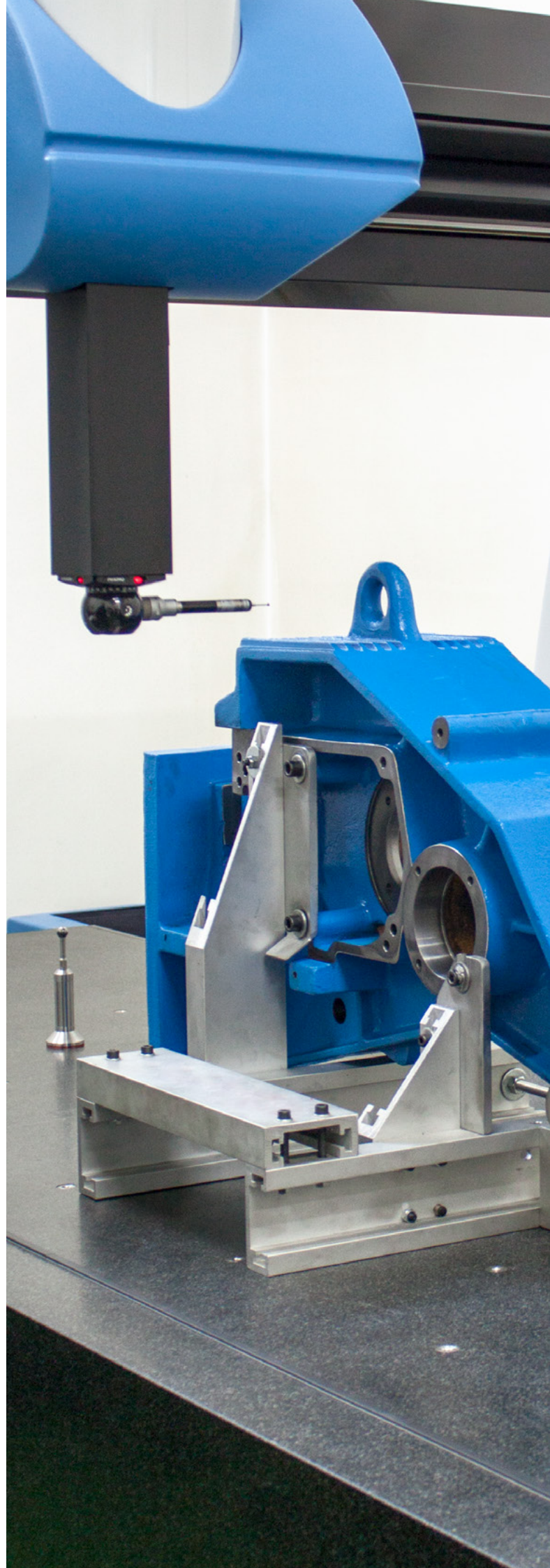

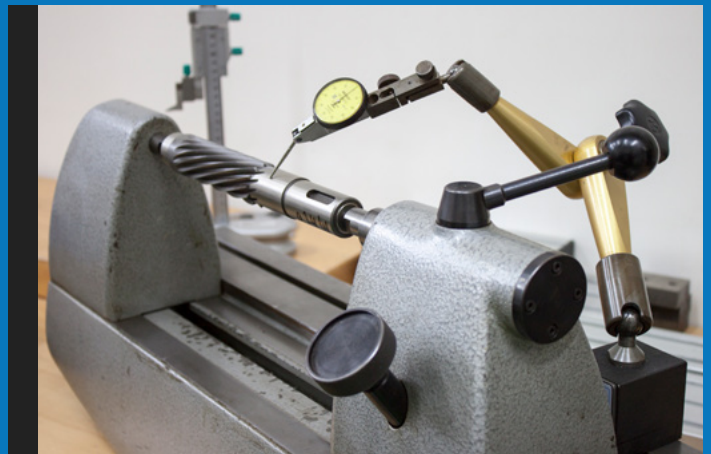

Metrology:

This is an essential element to ensure a high quality level. In **SIMA** we measure different magnitudes of a variety of components and accessories, looking into their normalization through traceability. With very narrow tolerance margins, the parts, components and accessories produced in **SIMA** enjoy the adequate measuring standards, always homogeneous and accurate.

Our laboratory is equipped with highly precise state of the art calibration and 3D measuring tools, which we also use to service other companies from different industries.

Competing successfully in our market it is not only about selling products in accordance with the regulations, but also about bringing forward proof of the conformity with the norms issued by certifying bodies.

In Europe, the norms are dictated by the Community regulations that execute the different norms issued in each directive.

As a machine manufacturer, **SIMA** is under the rule of the machinery directives approved by the European Community Council.

Furthermore, **SIMA** is accredited by AENOR certifications for design, production, distribution, etc. (ISO 9001:2008).

And let us not forget **SIMA's** concern for the environment, proven by our certification ISO 14001:2004, stating that our machines follow are produced using a sustainable and environmental friendly process.

After Sales Service

On 2006 **SERVISIMA** is created as a step forward from the After Sales Service that **SIMA** had been so far supplying. Besides taking care of any issue raised with machines breakdown both under or off guarantee, **SERVISIMA**, selects, appoints, trains, coordinates and maintains external points of service. These will be certified as **SERVISIMA** points (S.A.T.) and reported as such to **SIMA** customers.

SERVISIMA counts with a widespread variety of information for all **SIMA** models, including videos, pictures, parts diagrams, instruction manuals... for easier diagnostics and trouble shooting.

All technicians in **SERVISIMA** points of service count with a specialized training delivered by **SIMA**, complemented with specific sessions to keep them updated on new products and innovations in the range.

The repairs made in any **SERVISIMA** point of service enjoy a three months guarantee on spare parts and labor.

Moreover, the **SERVISIMA** points hold a permanent stock of the most commonly used spare parts of our machines, to allow a fast service to our customers. Would one spare part not be available in their stock, **SERVISIMA** will send it by courier within the 24 - 48 hours from the order. **SERVISIMA** is run by a team of six technicians who run a tracking system that ensures a quick and satisfactory response.

We are committed to repair any machine under guarantee in a period no longer than four days from the incidence report date, or seven days for machines out of guarantee.

Our **SERVISIMA** S.A.T. points comply with the quality standards stipulated by **SIMA** in all aspects of the service: product, spare parts and, not the least important, assistance and involvement with the customer needs.





servisima

- ✓ One year guarantee for the whole **SIMA** range.
- ✓ Worldwide service.
- ✓ Professional training to all **SERVISIMA** points and to the repair workshops of our distributors.
- ✓ Guaranteed stock of spare parts, and a swift delivery service to ensure a quick response.
- ✓ All repair operations are covered by a three month guarantee.
- ✓ **SIMA** technical team follows up all the repairs performed to acknowledge the customer satisfaction.

EXCELENCIA

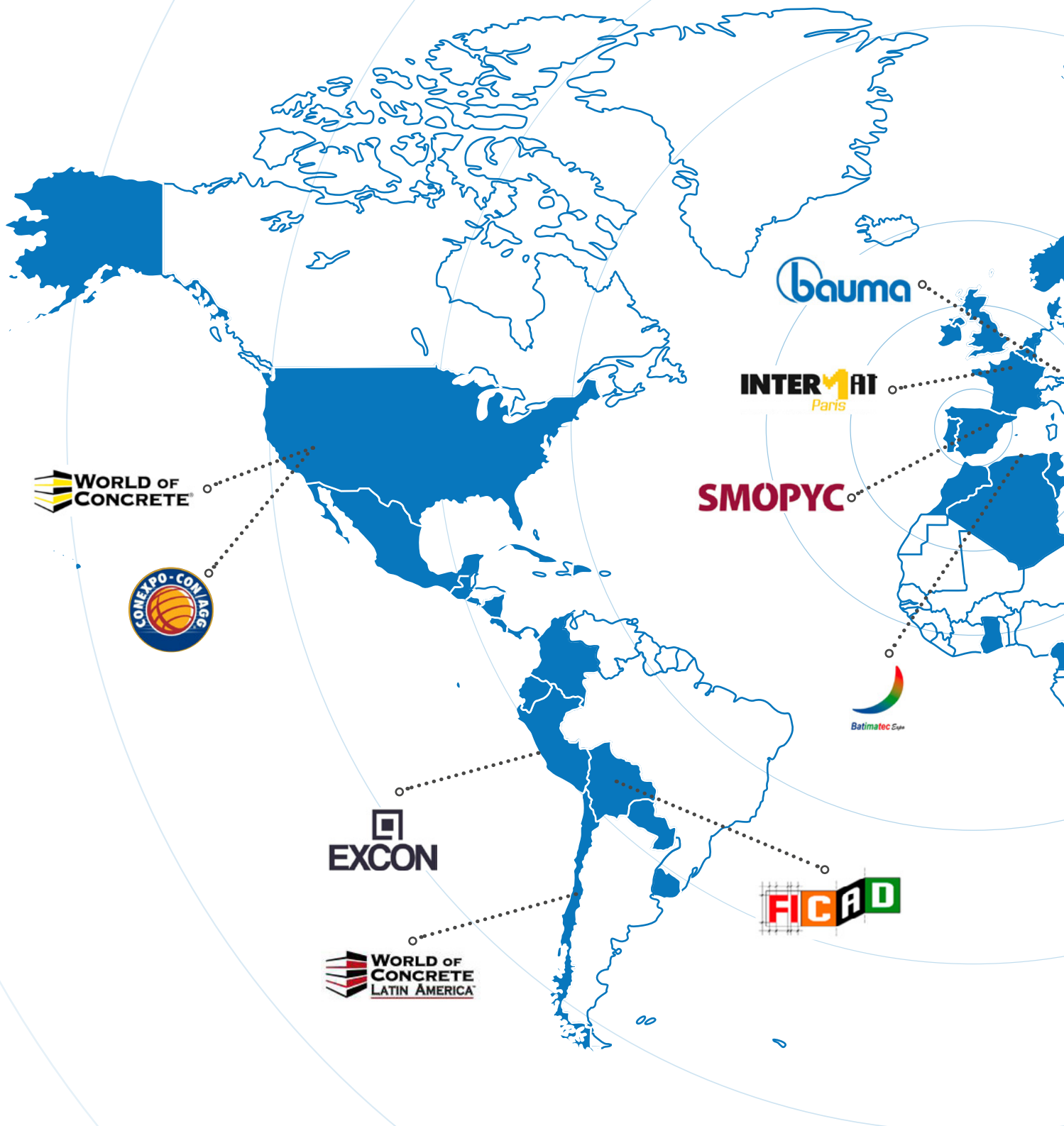

SIMA worldwide

SIMA has established a reputation as an international brand. Today, SIMA can be found in the five continents, with a foothold in 62 countries and a budding presence in other 15.

Our sales team is made of seasoned professionals that, depending on their time working for SIMA, are also qualified in the product technology, hence being able to deliver assessment to the client in two respects: commercial and technical.

It is key for the brand to attend the most relevant trade fairs in the sectors where SIMA operates, such as BAUMA, BIG 5,

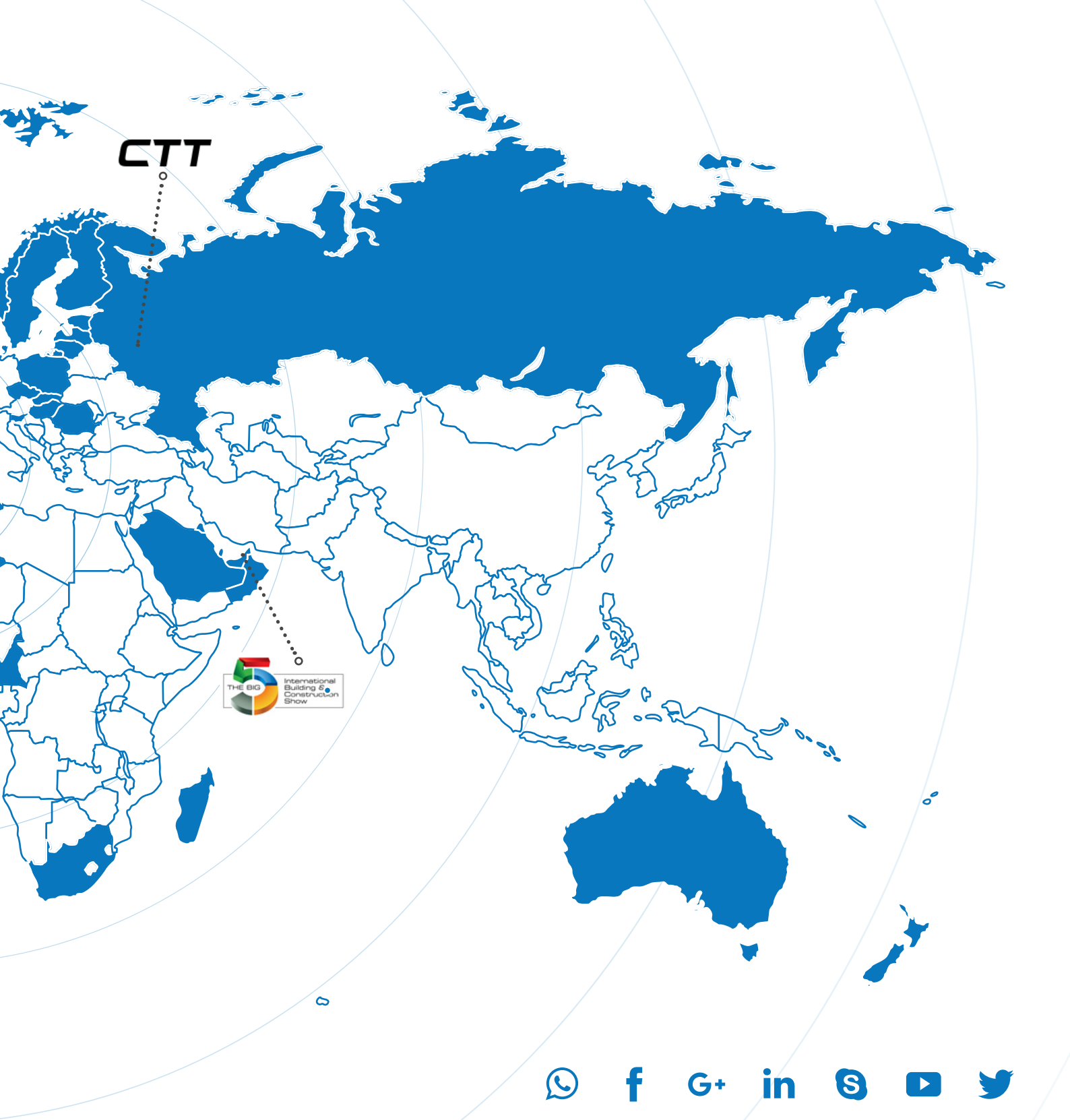

SMOPYC, INTERMAT, WOC and many more, some of them in coordination with our distributors.

Though **SIMA** typically operates through distributors (importing wholesalers in many countries), there are some exceptions.

Not two countries are alike from the business point of view. Each one has its own preferent channels and its own cultural and commercial singularities, to which we must adapt to succeed. This means for instance, to keep in certain countries a network of free agents to service distributors, subdistributors or hire

companies as direct customers.

Our flexible approach enables us to reach a number of O.E.M. customers for whom we produce under their own brand, specifications and requests.

In line with the current communication technologies, our website and our presence in the social media also help to provide additional sources of information and communication to our customers and end users, as well as being a contact point with anyone needing our services or just technical information about our products.

REBAR PROCESSING

- CEL Range
- DEL Range
- COMBI Range
- STAR Range
- SPIRAL Range
- ACCESSORIES
- TX 16
- DM 12
- C6
- Blades
- CX
- ATA 400

2





CEL Range

Electric Shears

CEL shears have become a reference in the market for cutting rebar: a range of four models with the highest performance for heavy duty cutting jobs.

Reliable, strong and durable. Highly resistant thanks to its cast-iron monoblock machined chassis. Excellent output in intensive rebar jobs, able to work more than 8 hours daily at construction sites or at rebar workshops

Specially recommended for rental fleets as high profitability, low maintenance running costs and durability, allowing long-term rentals.

Single-phase 230V motor version available for model **CEL 36 P**, which allows operation without a three phase electric supply from mains or gensets.

All **CEL** shears models are fitted with the compulsory safety systems and devices to comply with all international safety regulations:

- **Mechanical** safety devices: a shield covers the cutting jaw and blades. It prevents accidental operation as it locks foot and hand control.
- **Electrical** safety devices: emergency stop and low voltage cut-off device prevent the machine reloading after a supply cut. 60Hz motor versions are fitted with magneto-thermal breaker switch that stops the motor running on unstable supply.



CEL 42 P with elevator bench (optional)

FEATURES AND BENEFITS OF THE CEL RANGE



Interchangeable 4 faced long life cutting blades (set of 2 pcs.).

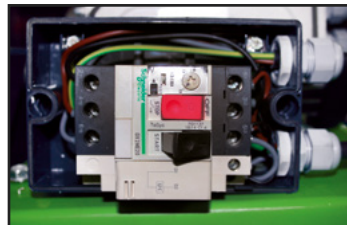

Magneto-thermic ON/OFF switch.

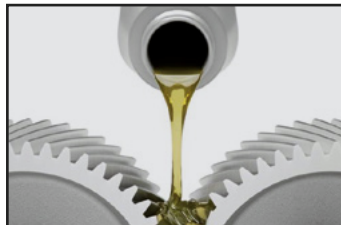

Oil bathed trapezoidal and Helicoidal gears for heavy duty.

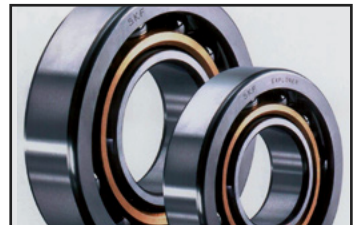

High end quality bearings.



Safety shield, fast and easy to use.

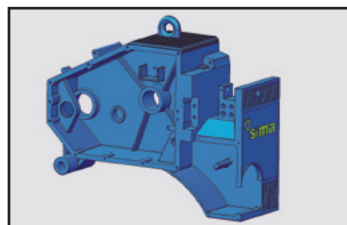

Heavy cast-iron monoblock chassis.

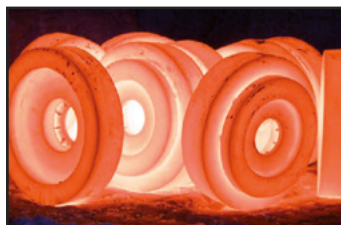

Inner components tempered for extended working life.



Lifting hook for easy transportation and shifting.

Long-life and top performance.

- Those inner components subject to continuous wearing and stress are tempered to ensure longer working life.
- Higher traction force and smooth running thanks to its oil bathed trapezoidal and helicoidal gears ensuring top performance for heavy users, and minimizing maintenance.
- High efficiency electric motor IE3 type. Featured with impact clutch which prevents slippery on cutting impacts and optimizes performance and accuracy.
- Interchangeable 4 faced long life cutting blades, rectangular shaped and made of chrome-steel.
- Comfortable and ergonomic foot or hand control with safety shield.
- Integrated lifting hook and lever + transport wheels to ease final positioning at site.



Cutting capacity

Yield strength / Grade	Re=N / mm ² 480 / G-60						Re=N / mm ² 650 / G-75					
	Rm=N / mm ² 650						Rm=N / mm ² 850					
Tensile strength												
No. x	1		2		3		1		2		3	
	mm	in / #	mm	in / #	mm	in / #	mm	in / #	mm	in / #	mm	in / #
CEL 36 P	Ø30	1-1/8" / 9	Ø20	3/4" / 6	Ø16	5/8" / 5	Ø25	1" / 8	Ø20	3/4" / 6	Ø16	5/8" / 5
CEL 42 P	Ø35	1-3/8" / 11	Ø25	1" / 8	Ø16	5/8" / 5	Ø32	1-1/4" / 10	Ø25	1" / 8	Ø16	3/4" / 6
CEL 52 P	Ø40	1-1/2" / 11	Ø25	1" / 8	Ø16	5/8" / 5	Ø40	1-1/2" / 11	Ø25	1" / 8	Ø16	3/4" / 6
CEL 55 P	Ø45	1-3/4" / 14	Ø32	1-1/4" / 10	Ø22	7/8" / 7	Ø40	1-3/4" / 14	Ø32	1-1/4" / 10	Ø20	3/4" / 6

	CEL 36 P					CEL 42 P		
	1 - PHASE		3 - PHASE		3 - PHASE	3 - PHASE		3 - PHASE
Item code	8055	8057	8054	8058	8039	8061	8072	8073
Motor voltage (V)	230		230 / 400			230 / 400		
Frequency (Hz) / In (pins)	50 / 3P	60 / 3P	50 / 4P	50 / 5P	60 / 4P	50 / 4P	50 / 5P	60 / 4P
Kw (Hp)	1,5 (2)	2,2 (3)	1,5 (2)			3 (4)		
Cuts / minute	110					100		
Oil capacity (L. / Gal.)	1/0,26					1,3/0,34		
Net weight (Kg. / Lbs.)	247 / 544,5					391,6 / 863,3		
Packaging dimensions L x W x H (mm / in)	1110 x 710 x 970 / 43,7" x 27,95" x 38,19"					1110 x 710 x 970 / 43,7" x 27,95" x 38,19"		

	CEL 52 P			CEL 55 P		
	3 - PHASE		3 - PHASE	3 - PHASE		3 - PHASE
Item code	8074	8075	8076	8081	8082	8083
Motor voltage (V)	230 / 400			230 / 400		230 / 400
Frequency (Hz) / In (pins)	50 / 4P	50 / 5P	60 / 4P	50 / 4P	50 / 5P	60 / 4P
Kw (Hp)	4 (5,5)			4 (5,5)		
Cuts / minute	88			50		
Oil capacity (L. / Gal.)	1,3 / 0,34			9 / 2,37		
Net weight (Kg. / Lbs.)	485 / 1069			666 / 1468		
Packaging dimensions L x W x H (mm / in)	1110 x 710 x 970 / 43,7" x 27,95" x 38,19"			1220 x 775 x 1130 / 48" x 30,51" x 44,48"		

DEL Range

Electric benders

Four models available to meet any rebar production requirements in both, job sites and rebar factories / workshops.

Supplied with the necessary pins, rollers and mandrels to produce the desired bending angle.

All models of **DEL** benders are also capable to produce stirrups, spirals and hoops using the optional accessories.

Easy low-cost maintenance can be even performed on site by the machine operator.

A single-phase 230V inverter version is available for model **DEL 32**. This machine operates without needing a three-phase electric supply. It aligns perfectly with the single-phase **CEL 36 P** rebar shear in medium scope rebar works.

All **DEL** benders are fitted with the compulsory safety systems and devices to comply with all international safety regulations:

- **Mechanical** safety devices: Automatic stop when frontal panel door opens or when the upper transparent polycarbonate shield is lifted.
- **Electrical** safety devices: Fully hermetic control panel, with right/left turn selector, voltage and amperage display and magneto-thermal protection breaker switch.



DEL 52

FEATURES AND BENEFITS OF THE DEL AND COMBI RANGE



Removable panels for easy maintenance access



Dirt and water resistant IP65 inductive sensor.



Volts and amps meter control display.



Internally mounted power socket to reduce wear and tear.



Overload magneto-thermal protection switch.



Hour meter to help on maintenance controls and rental fleets.



Impact-resistant emergency stop.



Curved protection visor for 360 degree visibility.

NEW

Innovation, flexibility and safety.

- Precise angle adjustment through pins and inductive sensors, dirt and water proof, much more reliable than standard limit switches.
- Side short rulers with holes for pins, allowing an accurate tuning on angle adjustment (models **DEL 32** and **DEL 36**).
- Models **DEL 45** and **DEL 52** featured with side long rulers which allows double bends for "Z" shaped figures (bottle neck shapes).
- Two speeds motor available upon request on models **DEL 32**, **DEL 36** and **DEL 45**.



Bending capacity DEL x2 speeds:

DEL 32 x2 speeds: fast: Ø16 mm (#5) – slow: Ø28 mm (#9)

DEL 36 x2 speeds: fast: Ø20 mm (#6) – slow: Ø32 mm (#10)







DEL 45 x2 speeds: fast: Ø25 mm (#8) – slow: Ø40 mm (#14)

Bending capacity

Yield strength / Grade	Re=N / mm ² 250 / G-40						Re=N / mm ² 480 / G-60						Re=N / mm ² 650 / G-75					
	Rm=N / mm ² 450						Rm=N / mm ² 650						Rm=N / mm ² 850					
Tensile strength	Rm=N / mm ² 450						Rm=N / mm ² 650						Rm=N / mm ² 850					
No. x 	1		2		3		1		2		3		1		2		3	
	mm	in / #	mm	in / #	mm	in / #	mm	in / #	mm	in / #	mm	in / #	mm	in / #	mm	in / #	mm	in / #
DEL 32	Ø32	1-1/4" / 10	Ø24	1" / 8	Ø18	3/4" / 6	Ø28	1-1/8" / 9	Ø20	7/8" / 7	Ø16	5/8" / 5	Ø25	1-1/8" / 9	Ø18	3/4" / 6	Ø14	1/2" / 4
DEL 36	Ø36	1-3/8" / 11	Ø26	1-1/8" / 9	Ø22	7/8" / 7	Ø32	1-1/4" / 10	Ø24	1" / 8	Ø18	3/4" / 6	Ø32	1-1/4" / 10	Ø22	7/8" / 7	Ø16	5/8" / 5
DEL 45	Ø45	1-3/4" / 14	Ø32	1-1/4" / 10	Ø25	1" / 8	Ø40	1-3/4" / 14	Ø32	1-1/4" / 10	Ø25	1" / 8	Ø40	1-3/8" / 11	Ø26	1" / 8	Ø25	1" / 8
DEL 52	Ø52	2"	Ø36	1-3/8" / 11	Ø30	1-1/8" / 9	Ø46	1-7/8"	Ø34	1-3/8" / 11	Ø25	1-1/8" / 9	Ø42	1-3/4" / 14	Ø32	1-1/8" / 10	Ø25	1-1/8" / 9

*For models DEL with 2 speeds motor, please check bending capacities with your sales representative.

Accessories included

							
Ø mm / in		Ø48 / 1,89"	Ø60 / 2,36"	Ø100 / 3,93"	Ø140 / 5,51"	Ø160 / 6,30"	Ø200 / 7,87"
DEL 32	1	4	4	1	1		2
DEL 36	1	4	4	1	1	1	2
DEL 45	1	4	4	1	1	1	2
DEL 52	1	4	4	1	1	1	2



	DEL 32				NEW: 2 speeds	DEL 36			NEW: 2 speeds
	1 - PHASE	3 - PHASE		3 - PHASE	DEL 32 2V	3 - PHASE		3 - PHASE	DEL 36 2V
Item code	20251504	20251500	20251502	20251501	20251505	20252000	20252002	20252001	20252005
Motor voltage (V)	230	230 / 400			230 / 400	230 / 400			230 / 400
Frequency (Hz) / In (pins)	50 - 60 / 3P	50 / 4P	50 / 5P	60 / 4P	50 / 5P	50 / 4P	50 / 5P	60 / 4P	50 / 5P
Kw (Hp)		2,2 (3)			3,3 (4,5)	3 (4)			4,5 (6,1)
Cycles / minute (bend/return) 1 st & 2 nd speed		11			11 / 22	10			10 / 20
Bending capacity 1 st & 2 nd speed					Ø28 / Ø26 mm				Ø32 / Ø20 mm
Oil capacity (L. / Gal.)		5,1 / 1,34			5,1 / 1,34	10 / 2,64			10 / 2,64
Net weight (Kg. / Lbs.)		302 / 665,79			302 / 665,79	355 / 782,64			355 / 782,64
Packaging dimensions L x W x H (mm / in)		950 x 850 x 1050 / 37,40" x 33,46" x 41,33"					950 x 850 x 1050 / 37,40" x 33,46" x 41,33"		

	DEL 45			NEW: 2 speeds	DEL 52		
	3 - PHASE		3 - PHASE	DEL 45 2 SP	3 - PHASE		3 - PHASE
Item code	20252500	20252502	20252501	20252505	20253000	20253002	20253001
Motor voltage (V)	230 / 400			230 / 400	230 / 400		
Frequency (Hz) / In (pins)	50 / 4P	50 / 5P	60 / 4P	50 / 5P	50 / 4P	50 / 5P	60 / 4P
Kw (Hp)	3 (4)			4,5 (6,1)	3 (4)		
Cycles / minute (bend/return) 1 st & 2 nd speed	6,5			10 / 20	6		
Bending capacity 1 st & 2 nd speed				Ø40 / Ø25 mm			
Oil capacity (L. / Gal.)	8,8 / 2,32			8,8 / 2,32	15 / 3,96		
Net weight (Kg. / Lbs.)	490 / 1080			490 / 1080	721 / 1589		
Packaging dimensions L x W x H (mm / in)	1080 x 1040 x 1170 / 42,52" x 40,94" x 46,06"					1080 x 1040 x 1170 / 42,52" x 40,94" x 46,06"	

COMBI Range

Combined electric bender & shears

Specially recommended for rebar production in small - medium housing or infrastructure projects with rebar sizes of up to Ø36mm / 1^{3/8}" (#11) for cutting and Ø52mm / 2" for bending, such as small resorts, condominiums, villas, low height apartment buildings, etc. A multi-purpose machine which also allows production of stirrups, spirals and hoops with its optional accessories.

The **COMBI** range is an ideal solution for small to medium rebar contractors and manufacturers, providing full working autonomy in any rebar work, and at a very low cost.

One machine, a single investment to do all rebar jobs with a medium production: bending, cutting, stirrups and spirals / hoops.

The most complete package.

- Safety shield with limit switch on shear body and bending table.
- Easy low-cost maintenance can be even performed on site by the machine operator.
- Single-phase 220V version with inverter technology available for model **COMBI 25/32**. The inverter stabilizes the electric supply so it makes the motor life longer. Two speeds motor available upon request on models **COMBI 25/32** and **COMBI 30/36**.



COMBI 30 - 36



Bending capacity **COMBI** x2 speeds:

COMBI 25-32 doble velocidad:

Bending fast speed: Ø 16 mm (#5) - Bending slow speed: Ø 28 mm (#9)

COMBI 30-36 doble velocidad:

Bending fast speed: Ø 20 mm (#6) - Bending slow speed: Ø 32 mm (#10)

FEATURES AND BENEFITS OF THE DEL AND COMBI RANGE

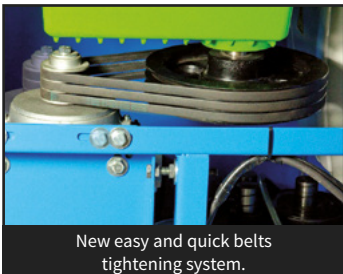

New easy and quick belts tightening system.



Protection shield for control panel.

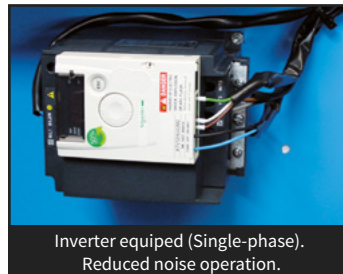

Inverter equipped (Single-phase).
Reduced noise operation.



Safety foot pedal control.



Pins with new anti stick lubrication system. Bolt for extracting pins (optional).

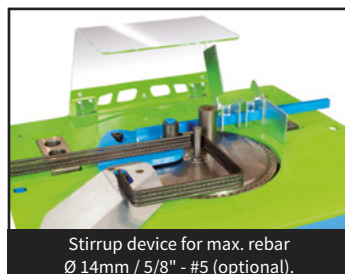

Stirrup device for max. rebar Ø 14mm / 5/8" - #5 (optional).



Large diameter rebars bending kit (optional).

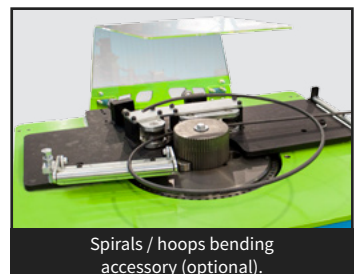

Spirals / hoops bending accessory (optional).

4-IN-1 MACHINE:



1 | Cutting, thanks to its shear jaw simultaneously operated with the bending plate.



2 | Bending, operated as our DEL range rebar benders.



3 | Stirrups production using the optional stirrups accessory.



4 | Production of spirals, rings and arches using the optional Spirals Bending accessory



COMBI 25 - 32

COMBI 36 - 52

Cutting / Bending capacity

Yield strength / Grade	Re=N / mm ² 250 / G-40						Re=N / mm ² 480 / G-60						Re=N / mm ² 650 / G-75					
Tensile strength	Rm=N / mm ² 450						Rm=N / mm ² 650						Rm=N / mm ² 850					
No. x	1	2	3	1	2	3	1	2	3	1	2	3	1	2	3	1	2	3
	Millimeters																	
COMBI 25 / 32	Ø25	Ø18	Ø12	Ø32	Ø24	Ø18	Ø20	Ø16	Ø10	Ø25	Ø20	Ø16	Ø20	Ø14	Ø8	Ø25	Ø18	Ø14
COMBI 30 / 36	Ø30	Ø20	Ø16	Ø36	Ø26	Ø22	Ø25	Ø18	Ø14	Ø32	Ø24	Ø18	Ø25	Ø16	Ø12	Ø32	Ø22	Ø16
COMBI 36 / 52	Ø36	Ø26	Ø22	Ø52	Ø36	Ø30	Ø32	Ø20	Ø16	Ø46	Ø34	Ø25	Ø32	Ø18	Ø16	Ø42	Ø32	Ø25
	In / #																	
COMBI 25 / 32	1" / 8	3/4" / 6	1/2" / 4	1-1/4" / 10	1" / 8	3/4" / 6	7/8" / 7	5/8" / 5	3/8" / 3	1-1/8" / 9	7/8" / 7	5/8" / 5	7/8" / 7	1/2" / 4	3/8" / 3	1-1/8" / 9	3/4" / 6	1/2" / 4
COMBI 30 / 36	1-1/8" / 9	7/8" / 7	5/8" / 5	1-3/8" / 11	1-1/8" / 9	7/8" / 7	1" / 8	3/4" / 6	1/2" / 4	1-1/4" / 10	1" / 8	3/4" / 6	1" / 8	5/8" / 5	1/2" / 4	1-1/4" / 10	7/8" / 7	5/8" / 5
COMBI 36 / 52	1-3/8" / 11	1" / 8	7/8" / 7	2"	1-3/8" / 11	1-1/8" / 9	1-1/4" / 10	7/8" / 7	5/8" / 5	1-7/8"	1-3/8" / 11	1-1/8" / 9	1-1/4" / 10	3/4" / 6	5/8" / 5	1-3/4" / 14	1-1/4" / 10	1-1/8" / 9

*For models COMBI with 2 speeds motor, please check bending capacities with your sales representative.

Accessories included

Ø mm / in		Ø48 / 1,89"	Ø60 / 2,36"	Ø100 / 3,93"	Ø140 / 5,51"	Ø160 / 6,30"	Ø200 / 7,87"					
COMBI 25 - 32	1	4	4	1	1			1		1		2
COMBI 30 - 36	1	4	4	1	1	1		1		1		2
COMBI 36 - 52	1	4	4	1	1	1	1	1		1		2



NEW: 2 speeds

NEW: 2 speeds

Item code	COMBI 25 - 32				COMBI 30 - 36			COMBI 36 - 52			
	1 - PHASE	3 - PHASE	2 SP.	3 - PHASE	3 - PHASE	2 SP.	3 - PHASE	3 - PHASE	3 - PHASE		
20351504	20351500	20351502	20351505	20351501	20352000	20352002	20352005	20352001	20352500	20352502	20352501
Motor voltage (V)	230	230 / 400			230 / 400				230 - 400		
Frequency (Hz) / In (pins)	50 - 60 / 3P	50 / 4P	50 / 5P	60 / 4P	50 / 4P	50 / 5P	60 / 4P	50 / 4P	50 / 4P	50 / 5P	60 / 4P
Kw (Hp)		2,2 (3)				3 (4)			3 (4)		
Cycles / minute (bend-cut / return)		11				10			6		
Oil capacity (L. / Gal.)		5,1 / 1,34				10 / 2,64			15 / 3,96		
Net weight (Kg. / Lbs.)		386 / 850,98				435 / 959,01			721 / 1589,53		
Packaging L x W x H (mm / in)	950 x 1080 x 1050 / 37,40" x 42,52" x 41,33"				950 x 1080 x 1050 / 37,40" x 42,52" x 41,33"			1080 x 1290 x 1190 / 42,52" x 50,78" x 46,85"			

STAR Range

Electric Stirrups Benders.

Rebar stirrups are the most common and repeating shapes used for rebar structures in construction, so the labour and time invested for its production is higher than any other rebar work.

Thanks to its handy and comfortable design, **STAR** stirrup bender delivers a high performance and productivity, up to 700 - 1000 stirrups per hour depending on the rebar size, the stirrup shape and the operator skill. **STAR** stirrup bender represents a very tiny investment in comparison to its high output, which makes it a perfect partner for rebar fabricators / workshops, for their serial stirrups productions and for rebar jobs at sites, thanks to its adaptability.

It is also quite suitable for builder's merchants or hardware stores with rebar supplying services.

Bending capacity up to rebar 16mm (5/8" - #5) for **STAR 16** and rebar 20mm (7/8" - #7) for **STAR 20**. Both models can bend multiple stirrups at the time with the same shape and bending quality.

Both models are available in single phase 230V and three phase 230V / 400V motor versions to ease the rebar works at any site.

The new **STAR 20** is featured with a 360° turning bending plate so as to work clockwise and counterclockwise, for an increased operational flexibility. Also supplied with holders to store rebars and provide an easier rebar feeding.



FEATURES AND BENEFITS OF THE STAR RANGE



Bending turning plate ergonomically designed for an easier operation.



Removable panels for easy maintenance access.

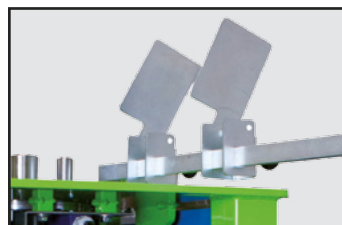

Adjustable folding length stops.



Angle selection pins with memory holders for 2 different angles programme.



Safety foot pedal control.



Full featured control panel.



Heavy-duty motor-reducer, 0% power loss.



Curved and transparent shield protection visor for 360 degree visibility.

Speed and versatility.

- **STAR 16** and **STAR-20** are not only able to produce standard stirrups but virtually any rebar shape typically used in rebar structures construction, such as: hooks, separators, anchorages, rebar feet, elbows, reinforcements, etc.
- Able to bend several rebar at the time depending on rebar size and strength (Grade).
- Easy and simple operation: it does not require highly qualified operators.
- All the necessary pins, rollers and mandrels, as well as the adjustable stop ruler are supplied as standard equipment.
- Pins and rollers can be customized upon request to suit to our customers requirements.
- Control panel designed and built in accordance with CE regulations.



Different bends and angles (among others)



Bending capacity

Yield strength / Grade	Re=N / mm ² 480 / G-60						Re=N / mm ² 650 / G-75					
Tensile strength	Rm=N / mm ² 650						Rm=N / mm ² 850					
No. x	7	6	5	3	1	1	7	6	5	2	1	1
Bending mandrels Ø mm / in	Ø18 / 0.71"	Ø24 / 0.94"	Ø36 / 1.41"	Ø36 / 1.41"	Ø48 / 1.89"	Ø48 / 1.89"	Ø18 / 0.71"	Ø24 / 0.94"	Ø36 / 1.41"	Ø36 / 1.41"	Ø48 / 1.89"	Ø48 / 1.89"
	Millimeters											
STAR 16	Ø6	Ø8	Ø10	Ø12	Ø16	Ø20	Ø6	Ø8	Ø10	Ø12	Ø16	Ø20
STAR 20	In / #											
STAR 16	Ø1/4"	Ø5/16"	Ø3/8" / #3	Ø1/2" / #4	Ø5/8" / #5	Ø7/8" / #7	Ø1/4"	Ø5/16"	Ø3/8" / #3	Ø1/2" / #4	Ø5/8" / #5	Ø7/8" / #7
STAR 20												

Accessories included

Ømm / in		Ø36 / 1 3/8"	Ø18 / 1 3/4"	Ø25 / 1"	Ø36 / 1 3/8"	Ø48 / 1 7/8"			
STAR 16	1	1	1	2	1	1	1	1	2
STAR 20	1	1	1	2	1	1	1	1	2



Item code	STAR 16			STAR 20			
	1 - PHASE	3 - PHASE		1 - PHASE	3 - PHASE	3 - PHASE	
Motor voltage (V)	230	230 / 400		230	230 / 400		
Frequency (Hz) / In (pins)	50 / 3P	50 - 60 / 4P	50 - 60 / 5P	50 - 60 / 3P	50 / 4P	50 / 5P	60 / 4P
Kw (Hp)	2,2 (3)	1,5 (2)	1,5 (2)	1,5			
Cycles / minute (bend / return)	19			17			
Net weight (Kg. / lbs.)	140 / 308,64			214 / 471,79			
Packaging dimensions L x W x H (mm / in)	850 x 760 x 680 / 33,46" x 29,92" x 26,77"			800 x 620 x 1040 / 31,49" x 24,41" x 40,94"			

SPIRAL Range

Spiral Hoop electric bender

Our machines **SPIRAL 26** and **SPIRAL 36** are specially designed to produce spiral or hoop rebar, at job sites or workshops, for structures used in any concrete circular formworks, such as foundations, scorings, water dams and reservoirs, domes, arches, tunnels and round pillars and columns.

They have a capacity from min rebar 6mm (1/4" - #1) up to max. rebar 26mm (1" - #8) and 36mm (1-3/8" / #11), depending on the machine model and the rebar strength (Grade).

Spiral Hoop bender.

- It does not require to pre-bend the leading end of the rebar.
- Safety pedal operated.
- Automatic or manual operation.
- Double speed operation, 7 or 14 meters (23ft. and 46ft.) per minute.
- Left and right bending turn.
- 2 tempered cog-wheel formers.
- Adjustable central cog-wheel for spiral or hoop curve radius.
- 2 ramps with rollers for pitch adjustment.
- Complete control panel, including emergency stop button, on/off switch, warning lights and operation switch selector.



SPIRAL 26

FEATURES AND BENEFITS OF THE SPIRAL RANGE



Designed for production of spirals, hoops and arches.



Adjustable formers.



Complete command centre.



Adjustable stop (SPIRAL 36).

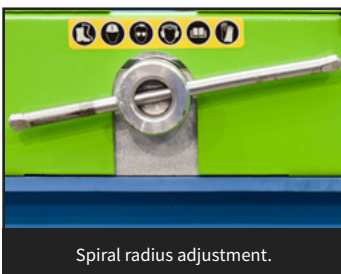

Spiral radius adjustment.



Impact-resistant emergency stop.



Motor reducer.

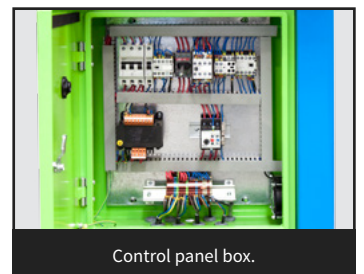

Control panel box.

APPLICATIONS:

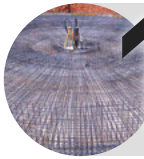

1

Applications in foundations and pipelines.



2

Applications in water dams and reservoirs.



3

Applications in domes, arches and tunnels.



4

Applications in round pillars and columns.



SPIRAL 26

SPIRAL 36

Bending capacity

Yield strength / Grade	Re=N / mm ² 480 / G-60	Re=N / mm ² 650 / G-75
Tensile strength	Rm=N / mm ² 650	Rm=N / mm ² 850
Minimum Ø spiral with rebar	Ø6 mm / 1/4"	
Minimum spiral Bending Ø mm (in.)	Ø 270 (11")	
	Millimeters - In (#)	
SPIRAL 26	Ø26 - 1" (#8)	Ø20 - 7/8" (#7)
SPIRAL 36	Ø32 - 1 1/4" (#10)	Ø26 - 1" (#8)

Accessories included

SPIRAL 26	1	1	1
SPIRAL 36	1	1	1

Item code	SPIRAL 26		SPIRAL 36	
	3 - PHASE	3 - PHASE	3 - PHASE	3 - PHASE
Motor voltage (V)	20251520	20251521	20252020	20252021
Frequency (Hz) / in (pins)	230 / 400		230 / 400	
Kw / Hp 1st. speed	50 / 5P		50 / 5P	
Kw / Hp 2nd. speed	60 / 4P		60 / 4P	
Cycles / minute 1st. speed	1,5 / 2		1,5 / 2	
Cycles / minute 2nd. speed	2,5 / 3,2		2,5 / 3,2	
Net weight (Kg. / Lbs.)	697		697	
Packaging dimensions L x W x H (mm / in)	1387		1387	
	300 / 661,38		430 / 948	
	1220 x 920 x 1150 / 48,03" x 36,22" x 45,27"		1220 x 920 x 1150 / 48,03" x 36,22" x 45,27"	

ACCESSORIES

Optional



R807600000. 4 rollers feeding bench for DEL.



R807500000. 4 rollers feeding bench for CEL.

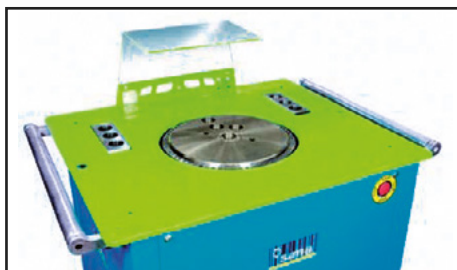

R202515009902 / R202525009902.
Side entry rollers for DEL & COMBI



R805440000. Elevator bench for CEL range.



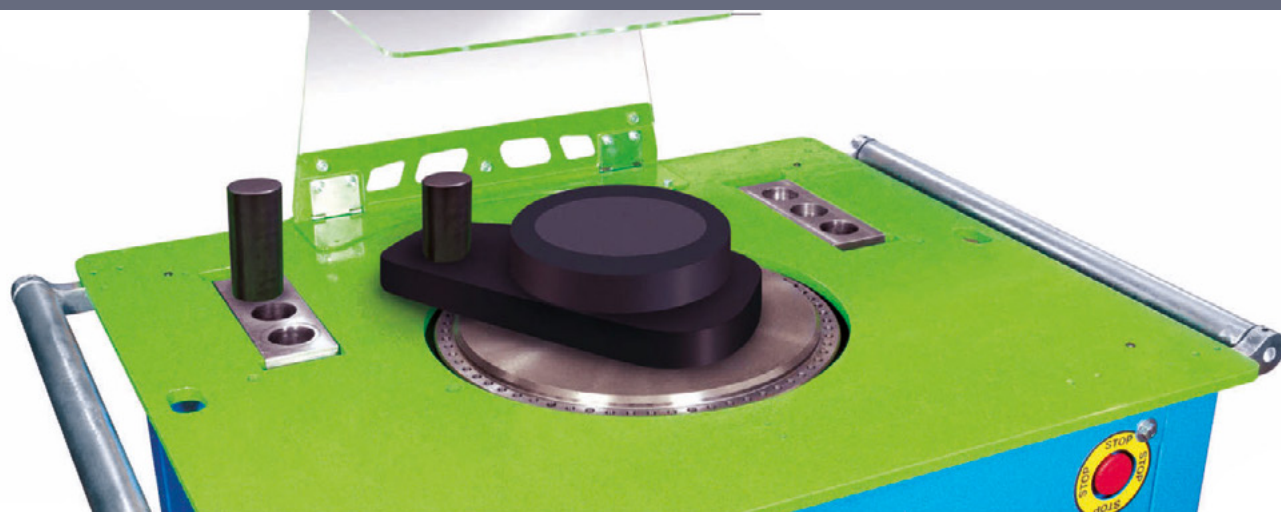

R202525006700. Pins extraction bolt.

LARGE DIAMETER REBARS BENDING KIT



Conforms to NORM UNE 36831

		DEL 32 COMBI 25 - 32	DEL 36 COMBI 30 - 36	DEL 45 COMBI 36 - 52
		R202515009900		R202525009500
Ø mm / in				
	Ø160 / 6,30"	R868067000	n.a	n.a
	Ø200 / 7,87"	R868069000		Del 45 - R868069000
	Ø250 / 9,84"	R868071000		Del 52 - COMBI 36/52 n.a
	Ø300 / 11,81"	R - 1207011		
	Ø381 / 15"	R868073000		
	Ø481 / 18,93"	n.a		R868074000

SPIRAL / HOOP BENDING ATTACHMENT



∅C

Min ∅6mm / 1/4" / #2 

Max. ∅20mm / 7/8" / #7 

DEL 32 - 36

DEL 45 - 52

COMBI 25 - 32 / 30 - 36

COMBI 36 - 52

∅275 / 11"

∅950 / 38"

Item code: R888800000

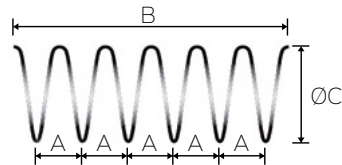

STIRRUP DEVICE

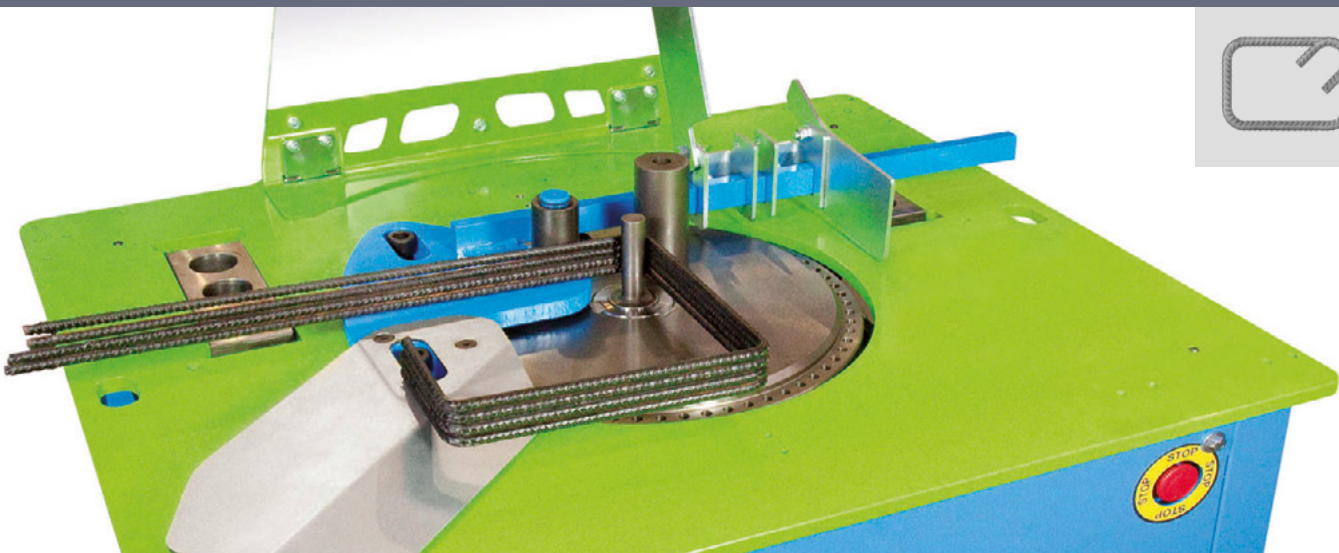

Max. 14 mm / 5/8" / #5 rebar

Bending Mandrels

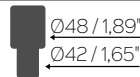
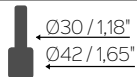
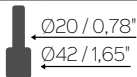

No. x 

7

4

2

2

1

∅mm / in / #

∅6 / 1/4" / #1

∅8 / 5/16" / #2

∅10 / 3/8" / #3

∅12 / 1/2" / #4

∅14 / 5/8" / #5

DEL 32 - 36

Item code: R202520009900

DEL 45 - 52

Item code: R202525009900

COMBI 25 - 32 / 30 - 36

Item code: R202520009900

COMBI 36 - 52

Item code: R202525009900

TX 16 Professional Bolt Cutter

BOLT CUTTER FOR REBAR AND STEEL BARS

- Cuts rebar from 2mm (0.08") up to 16mm (5/8" - #5). Reduces the cutting effort thanks to its wide jaws opening.
- Non-deformable handles made of high resistance 3mm thick steel.
- 3 faced long-life blades made of special steel-chrome and tempered to 58/60 HRC.
- Its special design allows cutting in difficult access rebar structures, rebar mesh, etc. Able to cut tiny rebars at floor level.

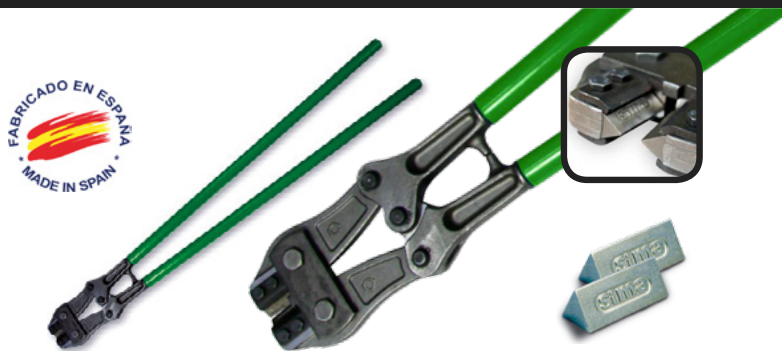

TX 16	
Item code	8541
Max. cutting (mm / in / #)	16 / 5/8" / #5
Net weight (Kg. / Lbs.)	7,8 / 17,19
Packaging dimensions LxWxH (mm / in)	1175 x 360 x 165 / 46,26" x 14,17" x 6,49"
Packaging	6 pieces

*Set of 2

DM 12 Manual stirrup bender

BENDS SEVERAL REBAR AT ONCE

- Featured with adjustable bar stop and ruler.
- Tempered pushing pin and mandrel.
- Holes for bench fixing.



DM 12	
Item code	0912
Max. bending Ø (mm / in / #)	12 - 1/2" / #4
Net weight (Kg. / Lbs.)	8,2 / 18,07
Packaging dimensions LxWxH (mm / in)	935 x 265 x 195 / 36,8" x 10,4" x 7,6"
Packaging	2 pieces

C6 Manual shear

EASY TO USE AND TOUGH BUILT

- Models **C6/28** and **C6/32** featured with an exclusive system to bring the blades closer for accurate effortless cutting.
- Extra lenght lever for an increased cutting power with less physical efforts.

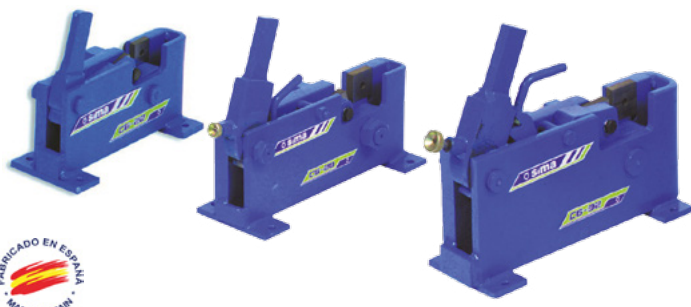

	C6 22	C6 28	C6 32
Item code	7000	7010	7020
Max. cutting Ø (mm / in / #)	22 / 7/8" / #7	28 / 1 1/8" / #9	32 / 1 1/4" / #10
Net weight (Kg. / Lbs.)	19 / 42	40 / 88	49 / 108
Packaging dimensions L x W x H (mm / in)	330 x 140 x 270 / 13" x 5,5" x 10,6"	500 x 190 x 270 / 19,6" x 7,4" x 10,6"	500 x 190 x 390 / 19,6" x 7,4" x 15,3"
Push lever dimensions L x W x H (mm / in)	1480 x 255 x 68 / 58,2" x 10" x 2,6"	2013 x 282 x 68 / 79,2" x 11,1" x 2,6"	2013 x 282 x 68 / 79,2" x 11,1" x 2,6"

BLADES Steel - chrome

4 FACED LONG-LIFE CUTTING BLADES

- Made of a highly resistant long-life steel-chrome alloy.



	CX 16	CX 20	CX 25	C6 22	C6 28	C6 32	TX 16
Item code	R - 3000201	R - 3000301	R - 3000401	R - 7000005	R - 7000006		R - 854199501
Cutting edges		4			8		3

CX Electrohydraulic Rebar Cutters

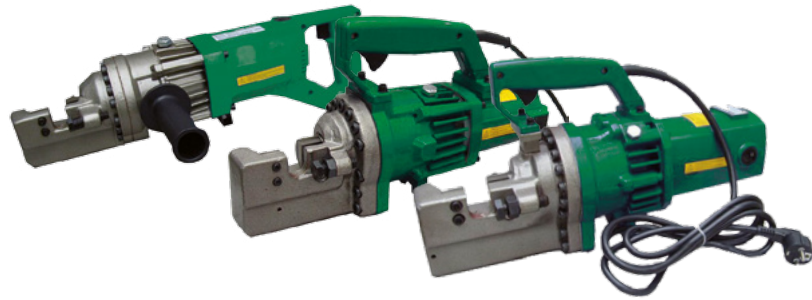

CAST-IRON CUTTING JAW

- High performance hydraulic pistons and reinforced frame and body.
- 4 faced long life blades and adjustable bar stop bolt/nut.
- Double insulation and a pressure relief valve to retract the piston.

	CX 16		CX 20		CX 25	
	1 - PHASE		1 - PHASE		1 - PHASE	
Item code	8160	8161	8165	8166	8170	8171
Motor voltage (V) / Amperage (Amp.)	230 / 3,8	110 / 8,1	230 / 4,3	110 / 11,3	230 / 7,2	110 / 15,5
Frequency (Hz) / in (pins)	50 - 60 / 2P		50 - 60 / 2P		50 - 60 / 2P	
W (Hp)	850 (1,1)	900 (1,2)	950 (1,3)	1250 (1,7)	1600 (2,2)	1700 (2,3)
Min-Max. cutting Ø (mm / in / #)	40 - 160 / 1/8" - 5/8" / #1 - #5		40 - 200 / 1/8" - 3/4" / #1 - #6		40 - 250 / 1/8" - 1" / #1 - #8	
Cutting speed (secs.- cut) / pressure	2,5 - 3 / 13 tonnes		3 - 3,5 / 15 tonnes		5 - 5,5 / 30 tonnes	
Blades life (cuts per set of 2)	Approx. 5000 (rebar Ø16 / 5/8" / #5)		Approx. 5000 (rebar Ø20 / 3/4" / #6)		Approx. 5000 (rebar Ø25 / 1" / #8)	
Net weight (Kg. / Lbs.)	8 / 17,6		13 / 28,6		24,5 / 54	
Packaging dimensions L x W x H (mm / in)	460 x 270 x 115 / 18" x 10,6" x 4,5"		546 x 255 x 160 / 21,4" x 10" x 6,2"		585 x 150 x 260 / 23" x 6" x 10,2"	

CX 16/20 Li-ion

BATTERY POWERED ELECTROHYDRAULIC REBAR CUTTERS

- Cordless and light weight, it runs on a 18V Lithium - ion battery.



	CX 16 LI-ION		CX 20 LI-ION	
	Item code	8162		8167
Motor voltage (V) / Amperage (Amp.)	18 / 2,2		18 / 2,6	
Min-Max. cutting (mm / in / #)	4 - 16 / 1/8" - 5/8" / #1 - #5		4 - 20 / 1/8" - 3/4" / #1 - #6	
Cutting speed (secs.- cut)	4 - 5 secs.		5 - 6 secs.	
Cuts per battery charge	50 - 60		50 - 60	
Net weight (Kg. / Lbs.)	13 / 28,6		15 / 33	
Packaging dimensions L x W x H (mm / in)	545 x 405 x 185 / 21,4" x 15,9" x 7,2"		545 x 405 x 185 / 21,4" x 15,9" x 7,2"	

ATA 450 Li Rebar tier

FAST AND STRONG TIE

- Tying selector for 2 or 3 wraps and 5 different levels of tying strength
- High operational speed. It works 5 times faster than traditional manual rebar tying, less than a second per tie.
- It runs on a 14.4V (3Ah.) Lithium-Ion quick-charge battery. Its amperage increases operational working life: up to 2200 ties approx.
- High technology inner electronics with beeps warning system for auto-diagnosis.
- Higher tying torque than other competitor's models, so it saves wire coils as it requires less quantity of tying shots (approx. 30% save).
- Suitable for most of wire coils available in the market, can use SIMA and most brands' coils.
- Featured with trigger lock for safety.



ATA 450 LI	
Item code	8534
Max. tying speed	0,8 seg. / tie
Ties per coil (3 / 2 wraps)	120 / 160 ties
Battery life	20 coils approx.
Voltage (V)	DC 14,4V - 3A / h
Battery type	LI-ION
Battery charging time	Approx. 70 min.
Wire coils packaging	Carton of 50 coils
Wire diameter (mm - in)	0,8 / 0,03"
Max. tying diameter (mm - in)	45 / 1,77.
Net weight (Kg. / Lbs.)	7,6 / 16,7
Packaging size L x W x H (mm / in)	485 x 135 x 385 / 18. x 5,3. x 15,15.

MASONRY SAWS FOR CONSTRUCTION MATERIALS

- MAGNUM Range
- BALI Mekano Range
- DAKAR Mekano Range
- VENUS Mekano Range
- PERLANATO Range
- EUOTRON 315 Plus / 315 XL
- HANDY 350
- AMBAR 200
- MIX Pro 1600
- ACCESSORIES

3





MAGNUM Range

Block and Stone Saw

The blocks saw **MAGNUM** is rugged and powerful. It provides a high performance in cutting large-sized blocks of poroton, pre-cast concrete, gasbeton, lime / sand stone and many other construction materials, always using the blade that better suits the material to cut.

There are two versions available: the 5.5 Kw (7,5 HP) for Ø700 mm (27") blades and the 7 Kw (10 HP) for Ø1000 mm (39") blades.

The **MAGNUM** includes such improvements as:

- 1. A new star-delta starter** to reduce the amperage intake on start.
 - When the start button is pushed, the motor gets started connecting the coils in series (delta mode), making the machine to work at just 80% of the total motor power.
 - After 10 seconds, it will automatically switch to full power by connecting the coils in star mode.
 - The red button will stop the machine in case of emergency.
- 2. Heavy duty water pump** with high flow of up to 40 litres (10.5 gal.) per minute.
- 3. The bed frame is reinforced** to make it more robust and to afford extra heavy materials.



MAGNUM 700



FEATURES AND BENEFITS OF THE MAGNUM RANGE

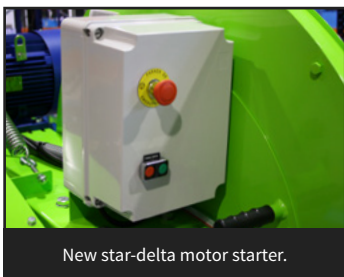

New star-delta motor starter.

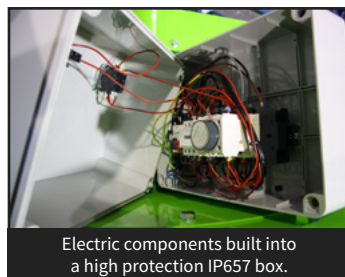

Electric components built into a high protection IP657 box.



Galvanised and removable water tub, long life and easy cleaning.

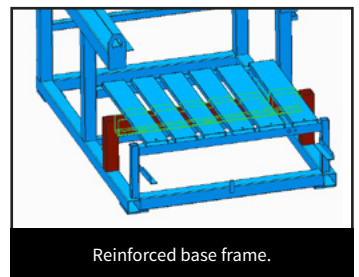

Reinforced base frame.



Handwheel operated mechanical feed.

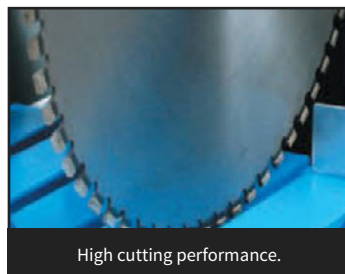

High cutting performance.



Heavy duty water pump, High flow to improve blade cooling.













Side rolling conveyor (optional).

Great cutting capacity.

- Handwheel operated mechanical feed, allowing a smooth effortless scrolling.
- Easy regulation of the cutting height with a very effective and safe locking system.
- Lasting durability, as it is built on a rugged monobloc chassis, and easy to move, as it is featured with four lockable wheels.
- Transmission by belts, providing a smooth and quiet operation and a high cutting accuracy.
- The diamond blade is cooled with water pumped from the tub or directly from the water mains.
- Large galvanized steel water tub, able to hold up to 87 litres (50 gal.), removable for easy cleaning.
- Long-life sealed bearings specially designed to work in a wet working environment.
- All the electronic parts comply with the different applicable European norms and regulations.
- Maximum cutting length up to 844 mm (33.2").
- Maximum cutting depth up to 420 mm (16.5").



For cutting a wide variety of materials

										
Materials	Bricks	Slate	Terrazzo	Concrete	Poroton	Ytong	Sandstone	Kerbstone	Granite	Marble

	MAGNUM 700	MAGNUM 1000
	3 - PHASE	3 - PHASE
Item code	6551	6552
Motor voltage (V)	400	400
Frequency (Hz) / In (pins)	50 / 5P	50 / 5P
Kw (Hp)	5,5 (7,5)	7,5 (10)
Water tub capacity (L. / Gal.)	87 / 22,9	87 / 22,9
Blade diameter (mm / in)	725 / 28"	1000 / 40"
Blade bore diameter (mm / in)	60 / 2,3"	60 / 2,3"
Blade included (mm / in)	No	No
Max. cutting length (mm / in)	844 / 33,2"	702 / 27,6"
Max. cutting depth (mm / in)	272 / 10,7"	420 / 16,5"
Net weight (Kg. / lbs.)	280 / 617,2	303 / 668
Packaging dimensions L x W x H (mm / in)	2160 x 1260 x 1500 / 85" X 49,6" x 59"	2160 x 1260 x 1500 / 85" X 49,6" x 59"

BALI Mekano Range

Brick and Block Saws

The innovative **Mekano** concept applied to the **BALI** range provides a variety of 100% customizable block cutters, to better adapt to each customer needs.

They are designed to work under very different conditions: both the cutting length and depth can be adjusted to the demands of each cutting job.

60 to 80% of the components in this range are manufactured to remain stainless, with more efficient and ecological materials.

They are prepared to cut any kind of blocks, such as pre-cast concrete, proton, gasbeton or terracotta, but also for many other construction materials: bricks, terrazzo, limestone, sandstone or kerbstones.

Made to last: aluminium body and galvanized steel water tub, providing higher resistance to oxidation.

The **BALI 700** series deliver a lighter and portable choice for large blocks cutting. They are available both in three-phase and single-phase versions, allowing these last ones their connection to a standard power supply.

The **BALI 500** series can use Ø400, Ø450 and Ø500 mm blades (16", 18" and 20"), delivering up to 200 mm (7.8") deep cuts in one pass.

The **BALI 700** series can use Ø600, Ø650 and Ø700 mm blades (24", 25" and 27"), delivering up to 270 mm (deep cuts in one pass).



▲ BALI 700 supplied with folding legs and wheels

FEATURES AND BENEFITS OF THE BALI MEKANO RANGE

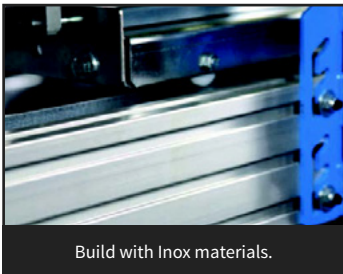

Build with Inox materials.



Poly-V belt transmission improves grip and reduces maintenance (**BALI 500 MK**).

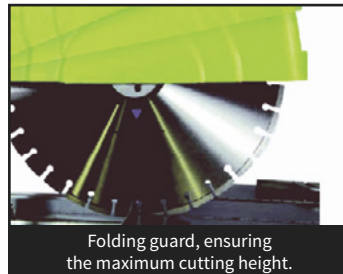

Folding guard, ensuring the maximum cutting height.

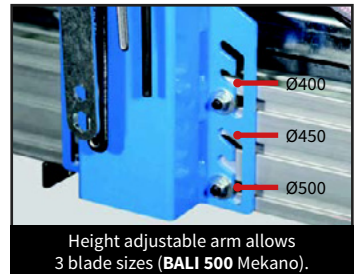

Height adjustable arm allows 3 blade sizes (**BALI 500 Mekano**).



Ø500 mm blade included in **BALI 500** Mekano.



Powerful single phase motor 3Kw (4Hp) version available in **BALI 700** Mekano.



Set of 2 handles for an easy handling (standard).



Folding legs and wheels.



The versatile and rugged block cutter.

- Its reduced size makes it easy to store.
- Anodized extruded aluminium body, durable and lighter for transportation and to move the machine at the job site.
- Galvanized steel basin to prevent oxidation.
- Rolling cart featured with a feed bar (**BALI 700**) slides over reinforced anodized aluminium rails, which improves the cutting quality and accuracy and prevents the oxidation caused by water contact.
- Deep cutting, ranging from 20 cm (7.8") in BALI 500 to 35 cm. (14") in **BALI 700**.
- The head can be easily adjusted in height to adapt to the different cutting depths needed.
- Low vibrations and extended blade performance when cutting, due to its robustness.
- Excellent machine for cutting the most common sizes of blocks.



For cutting a wide variety of materials

Materials	Bricks	Terrazzo	Concrete	Poroton	Ytong	Sandstone	Kerbstone	Marble

	BALI 500 MEKANO						
	1 - PHASE				3 - PHASE		3 - PHASE
Item code	0101002000	0101002001	0101002002	0101002003	0101002004	0101002005	0101002006
Motor voltage (V)	230		110		230 - 400		230
Frequency (Hz) / In (pins)	50 / 3P	60 / 3P	50 / 3P	60 / 3P	50 / 4P	50 / 5P	60 / 4P
Kw (Hp)	2,2 (3)			3 (4)			
Water tub capacity (L. / Gal.)				42 / 11			
Blade bore diameter (mm / in)				25,4 / 1"			
Max. blade diameter (mm / in)				400 / 450 / 500 - 16" / 18" / 20"			
Blade included (mm / in)				Yes, 500 / 20"			
Max. cutting length (mm / in)				480 / h 200 - 18,8" / h 7,8" (at maximum cutting depth)			
Max. cutting depth (mm / in)				200 / 7,8"			
Net weight (Kg. / lbs.)				89,2 / 197			
Packaging dimensions L x W x H (mm / in)				1260 x 880 x 640 / 49,6" x 34,6" x 25,1"			
Folding legs + wheels				Yes			

	BALI 700 MEKANO				
	1 - PHASE		3 - PHASE		3 - PHASE
Item code	0101002200	0101002201	0101002204	0101002205	0101002206
Motor voltage (V)	230		230 - 400		
Frequency (Hz) / In (pins)	50 / 3P	60 / 3P	50 / 4P	50 / 5P	60 / 4P
Kw (Hp)			3 (4)		
Water tub capacity (L. / Gal.)			42 / 11		
Blade bore diameter (mm / in)			25,4 / 1"		
Max. blade diameter (mm / in)			600 / 650 / 700 - 24" / 25" / 28"		
Blade included (mm / in)			No		
Max. cutting depth (mm / in) 1 passes			Blade Ø700 / 28": 270 / 10,6" - Blade Ø600 / 24": 230 / 9"		
Max. cutting depth (mm / in) 2 passes			Blade Ø700 / 28": 355 / 14" - Blade Ø600 / 24": 300 / 12"		
Max. cutting length (mm / in)			540 - 21,2" (at maximum cutting depth)		
Net weight (Kg. / lbs.)			128 / 282		
Packaging dimensions L x W x H (mm / in)			1450 x 850 x 800 / 57" x 33,4" x 31,4"		
Folding legs + wheels			Yes		

DAKAR Mekano Range

Masonry Saws

DAKAR Mekano embodies the perfect balance between quality and price in the world of the table saws. They can cut any material: bricks, tiles, kerbstones, granite, marble, roof tiles, etc.)

They offer top performance at the job site, cutting pieces up to 650 mm (25") long.

The models **DAKAR Mekano** and **DAKAR 400 Mekano** have removable legs, but they can be optionally fitted with folding legs and transport wheels.

It is 90% made of stainless materials. The remaining 10% is coated with an anti-rust epoxy-polyester paint.

The legs and head are removable making it easier to transport and move the machine on site.

The **DAKAR Mekano** and **400 Mekano** are rugged machines, easy to work with and optimized to yield an excellent performance at a very competitive price.

The **DAKAR Mekano 45** shares the capacities and cutting accuracy of all **DAKAR** models, but it adds the possibility of performing 45° bevel cuts, as well as to swinging the cutting head to the desired depth of cutting. At 45° it can cut pieces up to 650 mm long (25").

Extremely versatile, its cutting length can be modified as well, by moving the head arm alongside the frame, to best adapt to the cutting distance. Therefore, it is very easy to handle, facilitating the operator task and reducing the operation time.

The bigger wheels ease transportation and the small wheels help to put it inside the back of the van.



DAKAR MEKANO 45 with folding legs and wheels (Standard)

FEATURES AND BENEFITS OF THE DAKAR MEKANO RANGE



Reinforced aluminium frame and galvanized water tub: light, handy and rust free.



Adaptable blade height and able to bevel cut at 45° (only **DAKAR 45 MK**).



Folding legs and wheels (Optional for **DAKAR Mekano** and **DAKAR 400**).

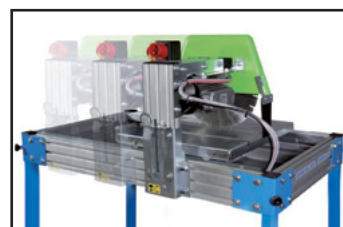

Adjustable cutting length. Higher comfort and productivity for short cuts.

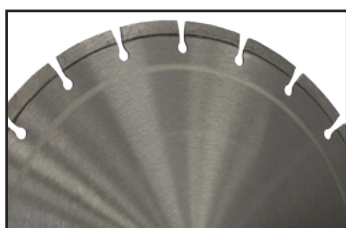

Ø350 or 400 mm blade included depending on model.



Cooling system for both blade sides.



Built in stainless materials and great durability epoxy-polyester paint.



Graduated reversible ruler.

90° and 45° cuts in large size pieces.

- Excellent value for money.
- Available in single-phase versions (3 Hp) and three-phase versions (4 Hp), to match every need.
- It offers to the user maximum performance at the work site, being able to cut pieces up to 65 cm long (25").
- Adjustable height (**DAKAR MK 45**) to allow cutting different thickness using the appropriate blade.
- Maximum cutting depth is 75 mm (3") for Ø300 mm (12") blade and 100 mm (4") for Ø350 blade (14").
- All **DAKAR** models are supplied with a diamond blade included.



	DAKAR MEKANO						
	1 - PHASE				3 - PHASE		3 - PHASE
Item code	0103005000	0103005001	0103005002	0103005003	0101005004	0101005005	0101005006
Motor voltage (V)	230		110		230 - 400		
Frequency (Hz) / In (pins)	50 / 3P	60 / 3P	50 / 3P	60 / 3P	50 / 4P	50 / 5P	60 / 4P
Kw (Hp)	2,2 (3)				3 (4)		
Water tub capacity (L. / Gal.)	42 / 11						
Blade bore diameter (mm / in)	25,4 / 1"						
Max. blade diameter (mm / in)	300 / 350 - 12" / 14"						
Blade included (mm / in)	Yes, 350 / 14"						
Max. cutting length (mm / in)	650 / h 20 - 25,5" / h 0,78"						
Max. cutting depth (mm / in)	75 mm with Ø300 blade (3" / 12"), 100 mm with Ø350 blade (4" / 14")						
Net weight (Kg. / lbs.)	69,2 / 152,5						
Packaging dimensions L x W x H (mm / in)	1260 x 800 x 510 / 49,6" x 31,4" x 20"						
Folding legs + wheels	Optional						

	DAKAR 400 MEKANO						
	1 - PHASE				3 - PHASE		3 - PHASE
Item code	0103006000	0103006001	0103006002	0103006003	0103006004	0103006005	0103006006
Motor voltage (V)	230		110		230 - 400		
Frequency (Hz) / In (pins)	50 / 3P	60 / 3P	50 / 3P	60 / 3P	50 / 4P	50 / 5P	60 / 4P
Kw (Hp)	2,2 (3)				3 (4)		
Water tub capacity (L. / Gal.)	42 / 11						
Blade bore diameter (mm / in)	25,4 / 1"						
Max. blade diameter (mm / in)	350 / 400 - 14" / 16"						
Blade included (mm / in)	Yes, 400 / 16"						
Max. cutting length (mm / in)	640 / h 25 - 25,1" / h 0,98"						
Max. cutting depth (mm / in)	100 mm with Ø350 blade (4" / 14"), 125 mm with Ø400 blade (5" / 16")						
Net weight (Kg. / lbs.)	71,4 / 157,4						
Packaging dimensions L x W x H (mm / in)	1260 x 800 x 510 / 49,6" x 31,4" x 20"						
Folding legs + wheels	Optional						

	DAKAR MK45						
	1 - PHASE				3 - PHASE		3 - PHASE
Item code	0103005200	0103005201	0103005202	0103005203	0103005204	0103005205	0103005206
Motor voltage (V)	230		110		230 - 400		
Frequency (Hz) / In (pins)	50 / 3P	60 / 3P	50 / 3P	60 / 3P	50 / 4P	50 / 5P	60 / 4P
Kw (Hp)	2,2 (3)				3 (4)		
Water tub capacity (L. / Gal.)	42 / 11						
Blade bore diameter (mm / in)	25,4 / 1"						
Max. blade diameter (mm / in)	300 / 350 - 12" / 14"						
Blade included (mm / in)	Yes, 350 / 14"						
Max. cutting length (mm / in)	650 / h 20 - 25,5" / h 0,78"						
Max. cutting depth (mm / in)	75 mm with Ø300 blade (3" / 12"), 100 mm with Ø350 blade (4" / 14")						
Net weight (Kg. / lbs.)	72,5 / 160						
Packaging dimensions L x W x H (mm / in)	1250 x 850 x 620 / 49,2" x 33,4" x 24,4"						
Folding legs + wheels	Yes						

VENUS Mekano Range

Masonry Saw

The **VENUS Mekano** range is conceived to straight or 45° angle cut all kind of construction materials, particularly those of larger size, quickly, precisely and with the highest quality.

Models **VENUS 125, 150** and **200** include a handwheel operated feed with a toothed belt transmission. It also includes a self-cleaning system of the sliding rails based on polishing felts and a folding guard in all models.

Model **VENUS 85** moves by operating a handle. As all **Mekano machines**, a 90 % of this range is manufactured with stainless materials.

The cutting head moves with the assistance of a bearings system mounted on an aluminium cart. These bearings are placed in 30° and 90° angles, ensuring a perfect straight or bevel cut, essential when cutting high value tiles and ceramics.

Their innovative upper bridge is also made in anodized reinforced aluminium. Fitting the cutting head is very easy and can use Ø300 mm (12") and Ø350 mm (14") blades.

It is the perfect machine to use at the job site and in marble or granite workshops, etc.

All the range models include a Ø350 mm blade as standard.

SIMA has available an especial **VENUS** model designed to performs cuts on polyurethane insulating panels. This model is delivered with a TCT blade and is fitted with the protection devices to ensure an easy, safe and fast cut.



VENUS 200 MEKANO

FEATURES AND BENEFITS OF THE VENUS MEKANO RANGE



Special model, adapted for cutting polyurethane insulating panels.



45° Tilting bridge.

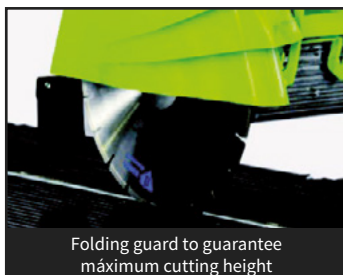

Folding guard to guarantee maximum cutting height.

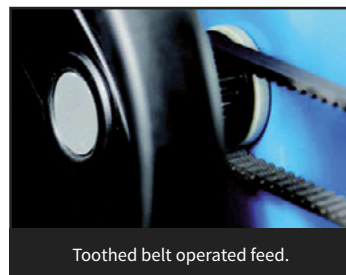

Toothed belt operated feed.

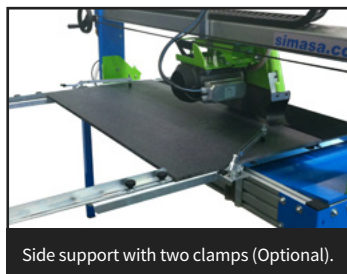

Side support with two clamps (Optional).



Set of 2 clamps for up to 5 cm high pieces (Optional).



Self-cleaning felts for the sliding.



Set of 2 handles for an easy handling (standard).

VENUS 85 MEKANO

	1 - PHASE				3 - PHASE		3 - PHASE
	0103002000	0103002001	0103002002	0103002003	0103002004	0103002005	0103002006
Item code							
Motor voltage (V)	230		110		230 - 400		
Frequency (Hz) / In (pins)	50 / 3P	60 / 3P	50 / 3P	60 / 3P	50 / 4P	50 / 5P	60 / 4P
Kw (Hp)	2,2 (3)				3 (4)		
Water tub capacity (L. / Gal.)					42 / 11		
Blade bore diameter (mm / in)					25,4 / 1"		
Max. blade diameter (mm / in)					300 / 350 - 12" / 14"		
Blade included (mm / in)					Yes, 350 / 14"		
Max. cutting length (mm / in)					850 / h 20 - 33,4" / h 0,78"		
Max. cutting depth (mm / in)					75 / 100 - 3" / 4"		
Net weight (Kg. / lbs.)					84 / 185		
Packaging dimensions LxWxH (mm / in)					1540 x 870 x 950 / 60,6" x 34,2" x 37,4"		
Folding legs + wheels					Yes		



VENUS 85 MEKANO

VENUS 125 MEKANO

	1 - PHASE				3 - PHASE		3 - PHASE
	0103003000	0103003001	0103003002	0103003003	0103003004	0103003005	0103003006
Item code							
Motor voltage (V)	230		110		230 - 400		
Frequency (Hz) / In (pins)	50 / 3P	60 / 3P	50 / 3P	60 / 3P	50 / 4P	50 / 5P	60 / 4P
Kw (Hp)	2,2 (3)				3 (4)		
Water tub capacity (L. / Gal.)					42 / 11		
Blade bore diameter (mm / in)					25,4 / 1"		
Max. blade diameter (mm / in)					300 / 350 - 12" / 14"		
Blade included (mm / in)					Yes, 350 / 14"		
Max. cutting length (mm / in)					1250 / h 20 - 49,2" / h 0,78"		
Max. cutting depth (mm / in)					75 / 100 - 3" / 4"		
Net weight (Kg. / lbs.)					102,7 / 227		
Packaging dimensions LxWxH (mm / in)					1960 x 870 x 950 / 77" x 34,2" x 37,4"		
Folding legs + wheels					Yes		



VENUS 125 MEKANO

VENUS 150 MEKANO

	1 - PHASE				3 - PHASE		3 - PHASE
	0103004000	0103004001	0103004002	0103004003	0101004004	0101004005	0101004006
Item code							
Motor voltage (V)	230		110		230 - 400		
Frequency (Hz) / In (pins)	50 / 3P	60 / 3P	50 / 3P	60 / 3P	50 / 4P	50 / 5P	60 / 4P
Kw (Hp)	2,2 (3)				3 (4)		
Water tub capacity (L. / Gal.)					42 / 11		
Blade bore diameter (mm / in)					25,4 / 1"		
Max. blade diameter (mm / in)					300 / 350 - 12" / 14"		
Blade included (mm / in)					Yes, 350 / 14"		
Max. cutting length (mm / in)					1500 / h 20 - 59" / h 0,78"		
Max. cutting depth (mm / in)					75 / 100 - 3" / 4"		
Net weight (Kg. / lbs.)					112,7 / 248		
Packaging dimensions LxWxH (mm / in)					2260 x 870 x 950 / 89" x 34,2" x 37,4"		
Folding legs + wheels					Yes		



VENUS 150 MEKANO

VENUS 200 MEKANO

	1 - PHASE				3 - PHASE		3 - PHASE
	0103007000	0103007001	0103007002	0103007003	0101007004	0101007005	0101007006
Item code							
Motor voltage (V)	230		110		230 - 400		
Frequency (Hz) / In (pins)	50 / 3P	60 / 3P	50 / 3P	60 / 3P	50 / 4P	50 / 5P	60 / 4P
Kw (Hp)	2,2 (3)				3 (4)		
Water tub capacity (L. / Gal.)					42 / 11		
Blade bore diameter (mm / in)					25,4 / 1"		
Max. blade diameter (mm / in)					300 / 350 - 12" / 14"		
Blade included (mm / in)					Yes, 350 / 14"		
Max. cutting length (mm / in)					2000 / h 20 - 78" / h 0,78"		
Max. cutting depth (mm / in)					75 / 100 - 3" / 4"		
Net weight (Kg. / lbs.)					135 / 297		
Packaging dimensions LxWxH (mm / in)					2800 x 870 x 950 / 110" x 32,4" x 37,4"		
Folding legs + wheels					Yes		



VENUS 200 MEKANO

PERLANATO Range

Portable Tiles Saws

Nowadays, the size of the ceramic materials that the tiles fitter works with tends to go bigger. New larger ceramic slabs, harder than before, require new tools to perform a perfect job.

The new **PERLANATO** is a machine especially conceived to cut ceramic and porcelanic slabs.

SIMA has a choice of models to match each need: from 700 mm (27.5") cutting length to 1000 mm (39.3"); and a different cutting depth upon the use of a Ø200 mm (8") or a Ø230 / Ø250 mm (9" / 10") diamond blade adjusting the head height.

It is both, rugged and lightweight, as it is built on an aluminium frame and other rust-free materials. The cut is always thin and accurate.

The **PERLANATO** range is versatile, practical, highly performant and durable.

They are perfect for cutting large slabs of hard porcelanic gres.

All models have folding legs, and wheels are optionally available.

Also as an option, they can be complemented with a side support with two clamps to lock the piece to the bench, for a more precise cut.



PERLANATO 250 1000



FEATURES AND BENEFITS OF THE PERLANATO RANGE



Adjustable tilting bridge - head for bevel cutting from 45° to 90°.

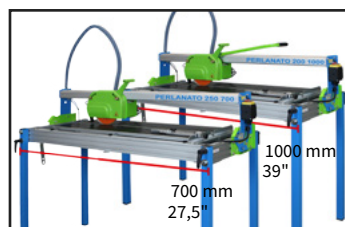

Two cutting lengths.



Side support with two clamps, improves precision while cutting (optional).

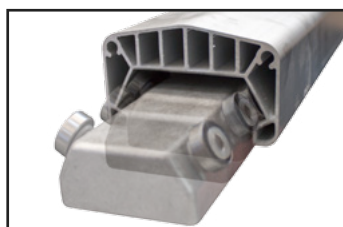

Precise sliding system, with bearings placed at 30° and 90° angle.

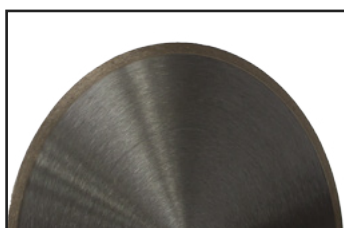

Ø200 or 250 mm blade included depending on model.



Reinforced aluminium frame and galvanized water tub: light, handy and rust free.

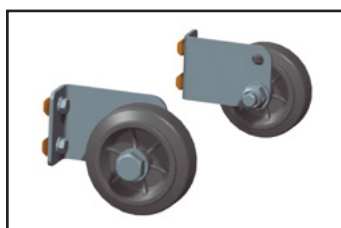

Set of wheels (optional).







Folding legs for an easier storage and transportation.

Efficient solutions.

- The **PERLANATO** range offers fast, reliable and efficient solutions, performing the two basic functions that the tile fitter needs on the work site: a 90° and 45° fine cut.
- The combination of its 1.5 Hp engine and the blade diameter (up to 250 mm / 10"), allows cutting all kind of materials up to 63 mm (2.4" high) (hard tiles, terrazzo, terracotta brick, marble, gres, etc.).
- All **PERLANATO** models are delivered with a tile cutting diamond blade included.
- The water supply hose pipe and wires are placed and lock so they never disturb the cutting field, but maintaining the necessary flexibility.
- As in all **SIMA** cutting tables, the locknuts that fix the blade guard to the head are tied to the guard, to avoid being lost.

Some cutting possibilities

			
Diagonal	45° cut	Straight cut	Straight cut



	PERLANATO 200 700			PERLANATO 200 1000		
	1 - PHASE			1 - PHASE		
Item code	0102001100	0102001101	0102001103	0102002100	0102002101	0102002103
Motor voltage (V)	230		110	230		110
Frequency (Hz) / In (pins)	50 / 2P	60 / 2P	60 / 2P	50 / 2P	60 / 2P	60 / 2P
Kw (Hp)	1,1 (1,5)			1,1 (1,5)		
Water tub capacity (L. / Gal.)	32 / 8,4			42 / 11		
Blade bore diameter (mm / in)	22,2 / 0,87"			22,2 / 0,87"		
Max. blade diameter (mm / in)	200 / 8"			200 / 8"		
Blade included (mm / in)	Yes, 200 / 8"			Yes, 200 / 8"		
Max. cutting length (mm - in)	700 / h 20 - 27,5" / h 0,78"			1000 / h 20 - 39,3" / h 0,78"		
Max. cutting depth (mm / in)	40 / 1,5"			40 / 1,5"		
Net weight (Kg. / lbs.)	50 / 110			57 / 126		
Packaging dimensions L x W x H (mm / in)	1150 x 580 x 415 / 45,2" x 22,8" x 16,3"			1450 x 580 x 415 / 57" x 22,8" x 16,3"		
Folding legs + wheels	Yes			Yes		

	PERLANATO 250 700			PERLANATO 250 1000		
	1 - PHASE			1 - PHASE		
Item code	0102001300	0102001301	0102001303	0102002300	0102002301	0102002303
Motor voltage (V)	230		110	230		110
Frequency (Hz) / In (pins)	50 / 2P	60 / 2P	60 / 2P	50 / 2P	60 / 2P	60 / 2P
Kw (Hp)	1,1 (1,5)			1,1 (1,5)		
Water tub capacity (L. / Gal.)	32 / 8,4			42 / 11"		
Blade bore diameter (mm / in)	22,2 / 0,87"			22,2 / 0,87"		
Max. blade diameter (mm - in)	230 / 250 - 9 / 10"			230 / 250 - 9 / 10"		
Blade included (mm / in)	Yes, 250 / 10"			Yes, 250 / 10"		
Max. cutting length (mm - in)	700 / h 20 - 27,5" / h 0,78"			1000 / h 20 - 39,3" / h 0,78"		
Max. cutting depth (mm - in)	53 / 63 - 2" / 2,4"			53 / 63 - 2" / 2,4"		
Net weight (Kg. / lbs.)	50 / 110			57 / 126		
Packaging dimensions L x W x H (mm / in)	1150 x 580 x 415 / 45,2" x 22,8" x 16,3"			1450 x 580 x 415 / 57" x 22,8" x 16,3"		
Folding legs + wheels	Yes			Yes		

EUROTRON 315 PLUS / 315 XL

Circular saws for wood

- Especially designed to cut any kind of wood panels up to 83 mm high (3.2").
- Reinforced chassis with folding blade guard, fully covering the blade.
- Transparent Polycarbonate blade screen, to keep your eyes on the cutting line.
- Very easy to set up. Easy to move.
- Legs reinforcing brackets. Robust legs can be anchored on the floor.
- CE certification, issued by the National Machinery Verification Centre, belonging to the Institute of Labour and Safety at Work.



	EUROTRON 315 PLUS						EUROTRON 315 XL					
	1 - PHASE		3 - PHASE		3 - PHASE		1 - PHASE		3 - PHASE		3 - PHASE	
Item code	3556	3571	3568	3564	3569	3572	10252500	10252503	10252501	10252504	10252505	10252506
Motor voltage (V)	230	110	230	400		230	230	110	230	400		230
Frequency (Hz) / In (pins)	50 / 3P	60 / 3P		50 / 4P	50 / 5P	60 / 4P	50 / 3P	60 / 3P		50 / 4P	50 / 5P	60 / 4P
Kw (Hp)	2,2 (3)			3 (4)			2,2 (3)			3 (4)		
Blade bore diameter (mm / in)	30 / 1,1"						30 / 1,1"					
Max. blade diameter (mm / in)	315 / 13"						315 / 13"					
Blade included (mm / in)	Yes, 315 / 13"						Yes, 315 / 13"					
Max. cutting depth (mm / in)	83 / 3,2"						83 / 3,2"					
Net weight (Kg. / lbs.)	56 / 123,4						66 / 145,5					
Packaging dimensions LxWxH (mm/in)	1080 x 690 x 1060 / 42,5" x 27" x 41,7"						1080 x 690 x 1060 / 42,5" x 27" x 41,7"					

FEATURES AND BENEFITS OF THE EUROTRON RANGE

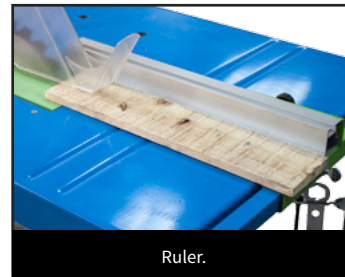
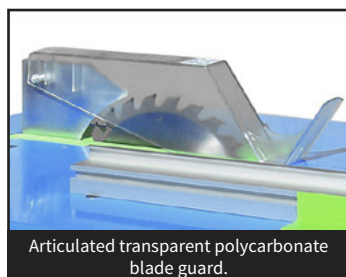

AMBAR 200

Portable tiles saw

- Versatile, handy, professional and easy to use and maintain
- The water tub can be removed for an easier cleaning.
- Easy, quick and reliable cutting solutions for the professional tiler. It can perform both, straight and 45° cuts.
- Removable legs to facilitate transportation.
- Cuts all kind of materials up to 35 mm (1.3") depth (tiles, terrazzo, bricks, marble, gres, porcelanic, etc.), with its Ø200 mm (8") diamond blade and a well dimensioned 1.5Hp motor.



AMBAR 200		
1 - PHASE		
Item code	1435	1436
Motor voltage (V)	230	110
Frequency (Hz) / In (pins)	50 / 2P	60 / 2P
Kw (Hp)	0,8 (1)	
Water tub capacity (L. / Gal.)	24 / 6,3	
Blade bore diameter (mm / in)	22,2 / 0,87"	
Max. blade diameter (mm / in)	200 / 8"	
Blade included (mm / in)	200 / 8"	
Max. cutting length (mm / in)	600 / h 20 - 23,6" / h 0,78"	
Max. cutting depth (mm / in)	35 / 1,3"	
Net weight (Kg. / lbs.)	32 / 70,5	
Medidas de embalaje LxAxH (mm / in)	960 x 570 x 430 / 37,7" x 22,4" x 17"	

MIX PRO 1600

Paddle Mixer

- Especially conceived for mixing paint, cement, glue, epoxis and single layers (up to 50 Kg. / 110 lbs.)
- Maximum mixing volume up to 200 litres / 52.8 gal. (with 160 mm / 6.2" mixing paddle).
- Electronic switch for a perfect control, particularly at the start of the mixing process, to avoid spatters, and two speeds gear box plus speed regulator.



* Mixing paddle included

MIX PRO 1600	
1 - PHASE	
Item code	8720
Motor voltage (V)	230
Frequency (Hz) / In (pins)	50 / 60
Kw (Hp)	1,6 (2,17)
Paddle diameter (mm / in)	160 / 6,2"
R.P.M. 1 st speed	150 - 400
R.P.M. 2 nd speed	250 - 700
Max. mixing volume (L. / Gal.)	200 / 52,8
Net weight (Kg. / lbs.)	6,2 / 13,6
Packaging dimensions L x W x H (mm / in)	210 x 400 x 940 / 8,2" x 15,7" x 37"

NEWS

VENUS 125 Polypanel

Structural Insulated Panels saw



Structural Insulated panels (SIP), as expanded polyurethane (PUR), polystyren panels (EPS), or rock wool panels, are being increasingly used in construction. Their high insulating and fire-resistant properties add to the lightweight of these materials and their attractive and varied finishings.

However, due to their size, they are cumbersome and difficult to handle. They are typically cut with powertools.

SIMA launches the only cutting table in the market especially designed to cut SIP panel: expanded Polyurethane (PUR) foam, Polystyren foam panels (EPS), and rock wool panels,

A lightweight affordable machine... with the performance of a stationary machine.



VENUS 125 POLYPANEL

*Roller supply feed (Optional).

Item code	VENUS 125 POLYPANEL							
	1 - PHASE				3 - PHASE		3 - PHASE	
0103003100	0103003101	0103003102	0103003103	0103003104	0103003105	0103003106		
Motor voltage (V)	230			110		230 - 400		
Frequency (Hz) / In (pins)	50 / 3P	60 / 3P	50 / 3P	60 / 3P	50 / 4P	50 / 5P	60 / 4P	
Kw (Hp)	2,2 (3)			3 (4)				
Water tub capacity (L / Gal.)				42 / 11				
Blade bore diameter (mm / in)				25,4 / 1"				
Max. blade diameter (mm / in)				300 / 350 - 12" / 14"				
Blade included (mm / in)				Yes, 350 / 14"				
Max. cutting length (mm / in)				1250 / h 20 - 49,21" / h 0,78"				
Max. cutting depth (mm / in)				75 mm with Ø300 blade (3" / 12") - 100 mm with Ø350 blade (4" / 14")				
Net weight (Kg. / lbs.)				117 kg. / 257 Lbs.				
Packaging dimensions LxWxH (mm / in)				1960 x 870 x 950 mm (77"x 34,2"x 37,4")				
Folding legs + wheels				Yes				

FEATURES AND BENEFITS OF THE VENUS 125 POLYPANEL

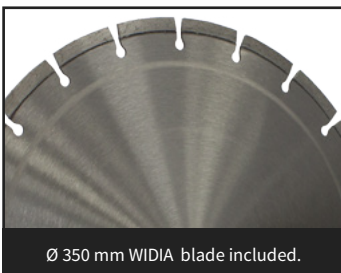

NEWS

HANDY 350

Dry cutting

HANDY is a rugged but lightweight masonry saw, intended for high performance dry cutting.

An efficient dust collection system, assisted by a vacuum cleaner, absorbs up to 90% of the cutting dust.

This feature makes it the perfect machine for indoors cutting works, refurbishing works, etc.

The machine also features a water circulation system for wet cutting too.



HANDY 350



Dry cutting



Wet cutting

HANDY 350			
1 - PHASE			
Item code	0103008100	0103008101	0103008102
Motor voltage (V)	230	110	
Frequency (Hz) / In (pins)	50 / 3P	60 / 3P	50 / 3P
Kw (Hp)		2,2	
Installed plug		3 Pins Schuko plug	
Blade Shaft diameter (mm / in)		25,4 / 1"	
Max. Blade diameter (mm / in)		350 / 14"	
Max. cutting depth (mm / in)		100 / 3,9"	
Max. cutting length (mm - in)		270 - 10,6" / 50 - 2"	
Net weight (Kg. / Lbs.)		38 / 83,7	
Packaging dimensions LxWxH (mm/in)		800 x 500 x 700 / 31,4" x 19,6" x 27,5"	

FEATURES AND BENEFITS OF THE HANDY 350



Rugged Steel Frame.



Can be used with the sliding cart...



...or as a chop saw, tilting the swinging head

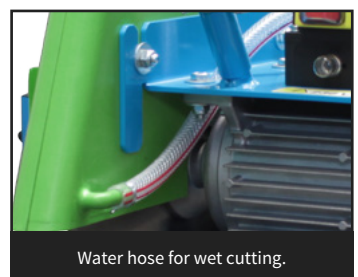

Water hose for wet cutting.

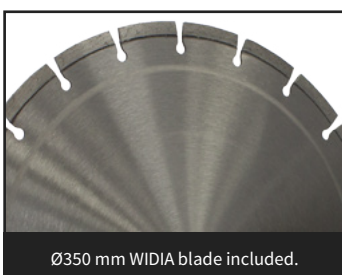

Ø350 mm WIDIA blade included.



Dust aspiration nozzle.



High resistance Polycarbonate guard.



2,2 Kw motor.

NEWS

HANDSAFE

Wood cutting saw

A wood cutting saw is typically one of the most dangerous machines in the construction sector, where it is often used to build the timbering or structural framework of the building foundations, among other uses. It is the one to cause most of the accidents that involve amputation.

Besides the mandatory safety elements that the norm demands, the **HANDSAFE** includes an innovative safety system that stops the blade moving in less than a second after it touches human flesh.

The **HANDSAFE** system operates with the combination of a ISS (Instant Stop System) sensor and a powerful motor brake, minimizing the damage suffered by the operator even in the case of negligent use of the machine.

Furthermore, the machine suffers no damage from this sudden stop. Just re-start the machine to have it working normally.

The new **HANDSAFE** wood cutter is heavier, more rugged and stable, with a strong tubular structure to increase its resistance. A machine for many hard working years.

With the new **HANDSAFE**, your safety is in your hands.



HANDSAFE

HANDSAFE FEATURES AND BENEFITS

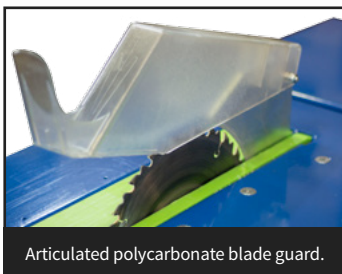

Articulated polycarbonate blade guard.



Tools and documents locker.

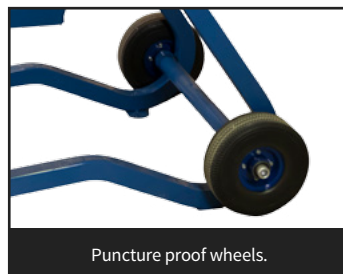

Puncture proof wheels.

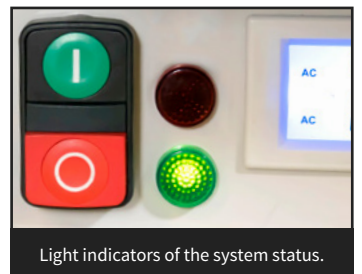

Light indicators of the system status.



Ø 315 mm. TCT Blade included.



Motor brake (< 1 sec)

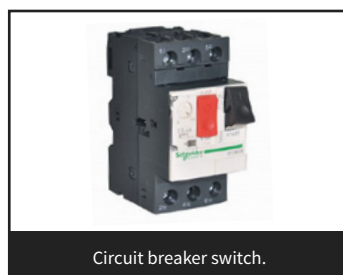

Circuit breaker switch.



Safety in accordance to
UNE-EN 1870-19



Unmatched safety in wood cutting works.

- The **HANDSAFE** wood cutter includes the safety blade guard that the norm demands. Made of light polycarbonate, it provides the necessary protection without increasing the machine weight.
- It also includes the plastic pushers according to the norm.
- Easy transportation, thanks to the Ø250 mm. polyurethane puncture-proof wheels. It can be hauled by one person even on irregular construction debris ground.
- The breaker included protects the machine from fluctuations in the electric power supply, tripping when it happens, and stopping the machine to protect the motor.
- Two light indicators tells the user when the machine is operative or when it has stopped after detecting human flesh on the blade or when the brushes need being replaced.
- Quick manual re-start after the machine stops.



HANDSAFE

Improper use



Improper use

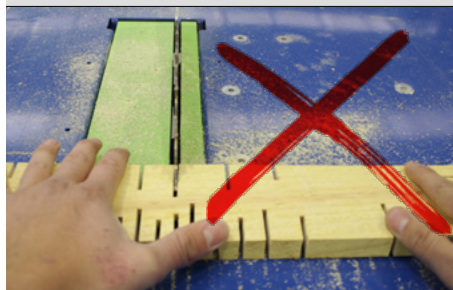

Proper use



Accessories included

HANDSAFE	1	1	1	1

	HANDSAFE					
	1 - PHASE			3 - PHASE		3 - PHASE
Item Code	10253000	10253003	10253001	10253004	10253005	10253006
Motor voltage (V)	230	110	230	400		230
Frequency Hz / Pin	50 / 3P		60 / 3P	50 / 4P	50 / 5P	60 / 4P
Kw (Hp)		2,2 (3)			3 (4)	
Blade bore diameter (mm / in)				30 / 1 ^{3/16} "		
Max. blade diameter (mm / in)				315 / 13"		
Blade included (mm / in)				Yes, 315 / 13"		
Max. cutting depth (mm / in)				83 mm / 9 ^{3/32} "		
Net weight (Kg. / in)				89 / 196		
Packaging dimensions LxWxH (mm / in)	1300 X 710 X 780 / 51,18" x 97,95" x 30,70"					

ACCESSORIES

Optional Accessories

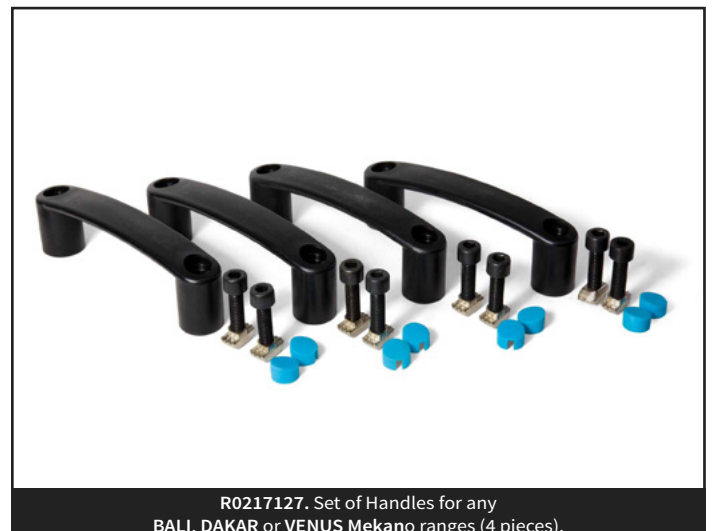
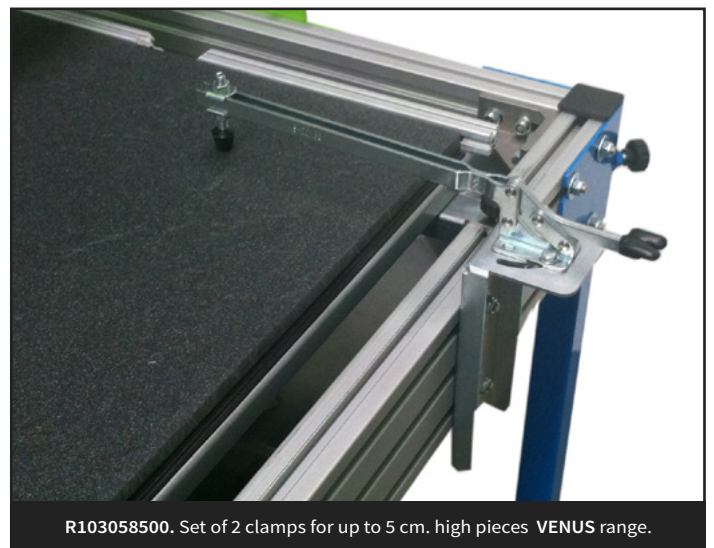



R102028500. Set of side support with 2 clamps for PERLANATO range.



R102028700. Set of wheels for PERLANATO (2 pieces).



R2106046. Cement mixing paddle
Ø160 mm for MIX PRO 1600.



R2106047. Fluids mixing paddle
Ø160 mm for MIX PRO 1600.



R103061500. 3m. extension cable + 3P plug + domestic plug
for 1-phase models.

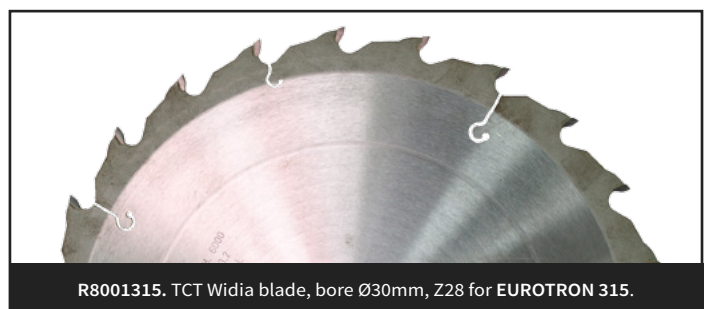

R8001315. TCT Widia blade, bore Ø30mm, Z28 for EUROTRON 315.

PAVING TREATMENT

- COBRA Pro Range
- COBRA Mekano Range
- COBRA 45/60 Range
- TRENCHER 60/70 Range
- HALCON Range
- DRILL 9
- RIG
- B50 I / C50 IB
- CAT 202
- ACCESSORIES
- The COBRA VARIO project

4





COBRA Pro Range

Floor Saws

SIMA is an international reference for pavement treating. The SIMA range covers all the demands that a professional in this sector would require. The technology high profile of our machines make them a very competitive choice.

Thanks to its very innovative design, the **COBRA 30** and **COBRA 35 PRO** is a fast, lightweight and easy to handle pavement cutter. It can work on discs of Ø300 mm (12"), Ø350 mm (14") and Ø400 mm (16").

And it also helps reducing not only the number of maintenance operations, but also the time that these operations usually take: easy and quick access to the belts, which do not need alignment when tighten.

The new roller tightening system makes this operation a matter of five minutes (instead of the 32 minutes that averages the tightening in conventional pavement cutters).

All this translates into a considerable money saving. The innovation goes even further. The transmission motor to shaft system placed with the cutting blade on the same side of the machine improves performance, while the Poly-V belt makes the most of the driving power with a reduced tensile strength. All to an improved efficiency and a longer life for the machine.

Finally, the depth regulation with a pneumatic spring is very comfortable and easy to use. The chassis is designed to remain always perfectly horizontal with the pavement, maximizing the cutting depth for the disc.

These **COBRAS** cut more than any other machine using the same disc diameter.



◀ COBRA 35 PRO HONDA



FEATURES AND BENEFITS OF THE COBRA PRO RANGE



Cutting depth regulated by pneumatic gas shock absorber.



Adjustable handle for better ergonomics.



Cutting depth control trigger: easy, fast and maintenance free.



Ø260 mm rear tubeless puncture-proof wheels.

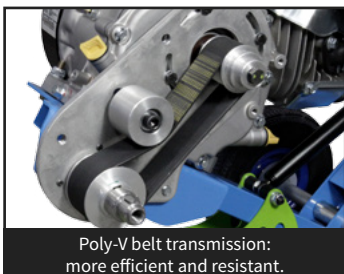

Poly-V belt transmission: more efficient and resistant.



Front handle for an easy lifting.

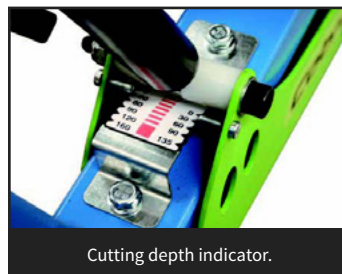

Cutting depth indicator.



20 litres water tank.

The deepest cut.

- Light and portable, for easy transportation even in small vehicles.
- Folding handlebars. Once folded, the machine size is very convenient for storing.
- Rugged and quick: perfect for rental companies.
- Depth regulation through pneumatic gas shock absorber, with height locking system.
- Rear axle adjustable sideways, allowing cuts close to walls or sidewalk kerbs, columns, etc.
- Wheels bearings protected from pressure water, when washing the machine, by hubcaps on both sides of the wheels. This protection extends the bearings life.
- Portable polycarbonate water tank (removable).
- Puncture proof rear wheels.



COBRA 35 PRO HONDA

COBRA 35 PRO KOHLER

Cutting Depth

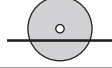
		
	mm	in
300 / 12"	105	4,13
350 / 14"	135	5,31
400 / 16"	160	6,3

Steps in conventional cutters	Total time 32 min
Removing the belts guard.	1 min
Pressure wash machine to remove dried dirt from the motor screws to be able to untighten.	5 min
Loosen the bolts of the base of the motor. Due to the tightness of the area where the bolts are loosened this has to be done with quarter turns of a wrench.	15 min
Tighten and align the belts.	5 min
Tighten bolts.	5 min
Mounting the belts guard.	1 min

Steps in COBRA 30 / 35 PRO	Total time 5 min
Removing the belts guard.	1 min
Not required.	-
Loosen the belt tightener pulley bolts.	1 min
Tighten the belt with no need to align.	1 min
Tighten the belt tightener pulley bolts.	1 min
Mounting the belts guard.	1 min

Item code	COBRA 30 PRO		COBRA 35 PRO		
	0202001103	0202001104	0202001100	0202001102	0202001105
Motor type	4-stroke / Gasoline		4-stroke / Gasoline		Electric 230 - 400 / Trif
Model motor	Honda GX200	Kohler CH270	Honda GX270	Kohler CH395	50Hz / 5P
Motor starter	Recoil		Recoil		Switch
HP	6,5		8,4	8,6	4 Kw / 5,5
Blade bore diameter (mm - in)	25,4 / 1"		25,4 / 1"		
Max. blade diameter (mm - in)	300 / 350 - 12 / 14"		350 / 400 - 14 / 16"		
Max. cutting depth (mm / in)	105 / 135 - 4" / 5,3"		135 / 160 - 5,3" / 6,2"		
Water tank capacity (L. Gal.)	20 / 5,2		20 / 5,2		
Net weight (Kg. / lbs.)	61 / 134		71,6 / 158		
Packaging dimensions L x W x H (mm / in)	1080 x 730 x 900 / 42,5" x 28,7" x 35,4"		1080 x 730 x 900 / 42,5" x 28,7" x 35,4"		
Disc included	No		No		

COBRA Mekano Range

Floor Saws

The pioneering **MEKANO** concept from **SIMA** implies that the machines designed under the **MEKANO** concept have many parts in common, its components being compatible with all models.

The **COBRA Mekano** is a fast and all-round pavement cutting machine, lightweight and easy to handle, which can operate with blades from Ø350 mm (14") up to Ø500 mm (20") size. Its innovative design allows a relevant reduction of both, the number of maintenance services and the time spent of each maintenance, which is 80% below as compared to any other conventional cutter. This obviously means a considerable reduction in maintenance costs.

For this reason, it is a very convenient machine for rentals. As in **COBRA 30 / 35 PRO**, the height adjustment is performed with a pneumatic gas shock absorber operated from a trigger in the handlebar.

Likewise, the transmission is efficiently performed by a Poly-V belt. This belt has a better grip and resistance and does not need to operate as tight as a conventional A or B type V-belt.



COBRA 40 MEKANO

FEATURES AND BENEFITS OF THE COBRA MEKANO RANGE

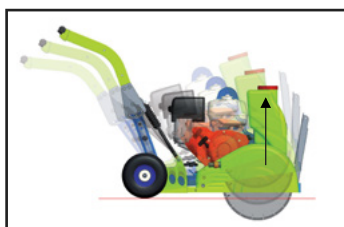

Cutting depth regulation.



Cutting depth regulated by pneumatic gas shock absorber.

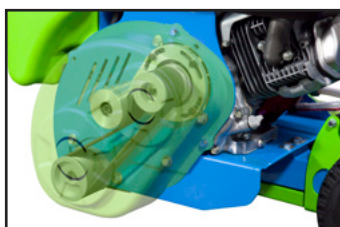

Poly V transmission, improves grip and increase power transmission.



Adjustable handle for better ergonomics.



Front handle for an easy lifting.



Rear tubeless puncture-proof wheels and adjustable axle.



Lifting bracket.



Protection guard for the gears and the blade shaft.

Lightweight and Nimble.

- Both the 40 and 50 models are designed to use bigger diamond blades.
- The **COBRA 40 Mekano** can operate with Ø350 mm (14") and Ø400 mm (16") blades, reaching up to 132 mm (5.2") cutting depth. The **COBRA Mekano 50** can operate with Ø450 mm (18") and Ø500 mm (20") blades, which reach a maximum cutting depth of up to 182 mm (7.1").
- Strong and long lasting, with an improved motor performance and a smoother running.
- A variety of motors are available for both models, up to 14 Hp and with the possibility of a cyclone air filter motor.



Cutting depth

	mm	in
350 / 14"	107	4,21
400 / 16"	132	5,19
450 / 18"	157	6,14
500 / 20"	182	7,16

	COBRA 40 MEKANO			
Item code	0202001000	0202001001*	0202001002	0202001003
Motor type	4-stroke / Gasoline			
Model motor	Honda GX390	Honda GX390	Kohler CH440 CYC	Honda GX390 CYC
Motor starter	Recoil			
HP	13		14	13
Blade bore diameter (mm / in)	25,4 / 1"			
Max. blade diameter (mm / in)	350 / 400 - 14 / 16"			
Max. cutting depth (mm / (in)	107 / 132 - 4,2" / 5"			
Water tank capacity (L. Gal.)	20 / 5,2			
Net weight (Kg. / lbs.)	89 / 196,2			
Packaging dimensions L x W x H (mm / in)	1080 x 730 x 900 / 42,5" x 28,7" x 35,4"			
Disc included	No			

*No CE

	COBRA 50 MEKANO			
Item code	0202004000	0202004001*	0202004002	0202004003
Motor type	4-stroke / Gasoline			
Model motor	Honda GX390	Honda GX390	Kohler CH440 CYC	Honda GX390 CYC
Motor starter	Recoil			
HP	13		14	13
Blade bore diameter (mm / in)	25,4 / 1"			
Max. blade diameter (mm / in)	450 / 500 - 18 / 20"			
Max. cutting depth (mm / (in)	157 / 182 - 6" / 7"			
Water tank capacity (L. Gal.)	20 / 5,2			
Net weight (Kg. / lbs.)	89 / 196,2			
Packaging dimensions L x W x H (mm / in)	1080 x 730 x 900 / 42,5" x 28,7" x 35,4"			
Disc included	No			

*No CE

COBRA 45/60 Range

Floor Saws

The **COBRA** series machines are rough and all-round, with an excellent output.

Both of them include a polypropylene water tank of 40 or 50 litres depending on the model (10.5 gal. or 13.2 gal.).

Though very robust, the design is ergonomic to provide an easy use and to ensure unbeatable performance in large areas such as motorways, roads, industrial buildings, airports, etc.

Great performance and versatility.

- Depth indicator.
- Two ways blade cooling system, either from the built-in water tank or the water mains.
- Push feed (**COBRA 45**) or mechanical hand wheel operated (**COBRA 60**).
- Cutting adjustment by handle with locking system.
- Cutting depth control by trapezoidal thread shaft on a cast iron housing mounted gear.
- Especially designed for heavy duty, including rental works.
- Easy access to the blade.



COBRA 45 HONDA

FEATURES AND BENEFITS OF THE COBRA RANGE



Rubber band wheels with ball bearings.

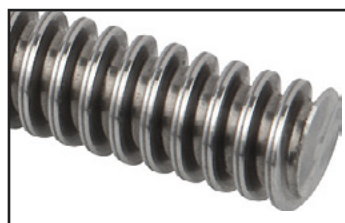

Cutting depth operated by trapezoidal thread shaft.

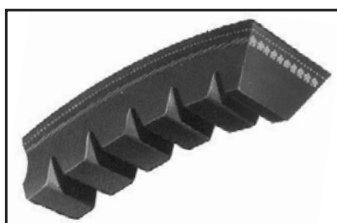

Trapezoidal transmission belts (Honda and Lombardini).



Poly-V belt transmission (Yanmar).



Water cooling fork, reaching both blade sides.



40 or 50 litres water tank (model **COBRA 40** or **COBRA 50** respectively).

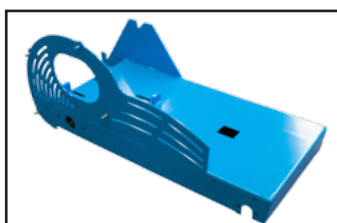

Robust chassis.



Cutting depth indicator.

HOW TO CUT:

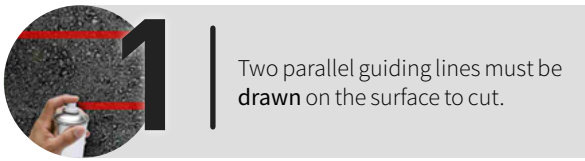

Two parallel guiding lines must be **drawn** on the surface to cut.



We proceed to **cut** the first line, and then we cut the second on return.



The excavator can then start to dig.



Multiple Cut

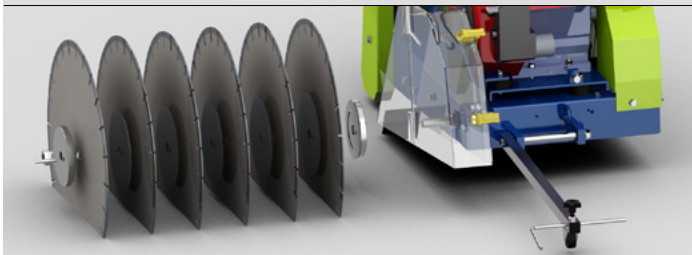

The **COBRA Vario** concept regards the possibility of producing multiple parallel cuts by using more than one blade (see page 73).

	COBRA 45			
Item code	2565	2603*	2587	2585
Motor type	4-stroke / Diesel		4-stroke / Gasoline	
Model motor	Yanmar L100AE - DYC		Honda GX390	Honda GX390 CYC
Motor starter			Recoil	
HP	10		13	
Blade bore diameter (mm / in)			25,4 / 1"	
Max. blade diameter (mm - in)			450 / 500 - 18" / 20"	
Max. cutting depth (mm - (in)	145 / 170 - 5,7" / 6,7"		145 / 170 - 5,7" / 6,7"	
Water tank capacity (L. Gal.)			40 / 10,5	
Net weight (Kg. / lbs.)	125,5 / 276,6		110 / 242,5	
Packaging dimensions L x W x H (mm / in)			1180 x 670 x 1050 / 46,4" x 26,3" x 41,3"	
Disc included			No	

*Not CE

	COBRA 60			
Item code	2506	2507	2508	2509
Motor type	Gasoline 4 T		Diesel 4 T	
Model motor	Honda GX390	Honda GX390 CYC	Honda GX630	Lombardini MD 190
Motor starter	Recoil		Electric	
HP	13		23	
Blade bore diameter (mm / in)			25,4 / 1"	
Max. blade diameter (mm / in)			600 / 24"	
Max. cutting depth (mm / (in)			200 / 7,8"	
Water tank capacity (L. Gal.)			50 / 13,2	
Net weight (Kg. / lbs.)	188 / 414		234 / 516	
Packaging dimensions L x W x H (mm / in)			1480 x 830 x 1190 / 58,2" x 32,6" x 46,8"	
Disc included			No	

TRENCHER 60/70 Range

Specialised in trenching

A **TRENCHER** is a pavement cutting machine that can operate with either one or two blades of Ø350 mm (14") or Ø400 mm (16") and Ø450 mm (18") or Ø500 mm (20").

The distance between the two blades can be adjusted to 60 cm, 65 cm. and 70 cm. (24", 26" and 28").

The main use of the **TRENCHER** is to perform two parallel cuts in one pass, so the excavator can follow digging behind. If the surface to cut is steep, the machine needs only to work downwards.

It can also be operated as a conventional cutter, with the blade placed on either sides.

Besides, the **TRENCHER** can also be adapted, with the optional accessories needed, to perform two very close parallel cuts of 5 cm, 8 cm or 10 cm wide.

It is a very rugged and all-round machine, improved for heavy duty works always performing with precision and reliability.



TRENCHER 60/70 HONDA

Cutting width possibilities:

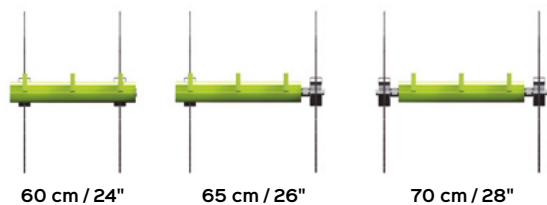

FEATURES AND BENEFITS OF THE TRENCHER RANGE



Cutting depth operated by a Ø250 mm handwheel and a gas shock absorber.

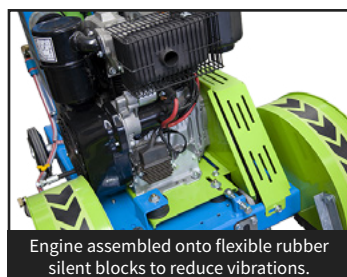

Engine assembled onto flexible rubber silent blocks to reduce vibrations.

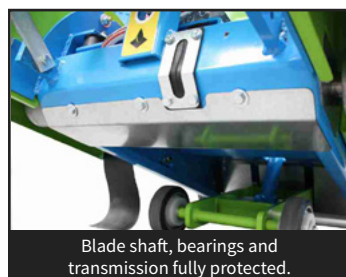

Blade shaft, bearings and transmission fully protected.



Oil level disp stick and oil filler hole.



Anti vibration height adaptable handle bar.

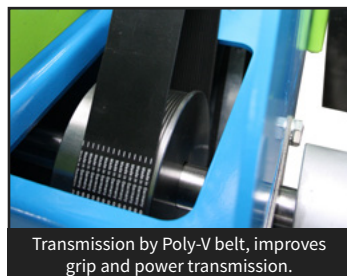

Transmission by Poly-V belt, improves grip and power transmission.

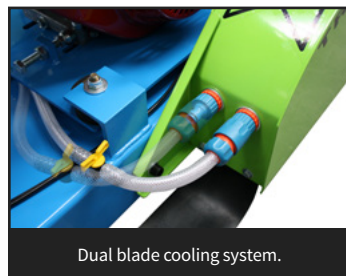

Dual blade cooling system.



Regulation for three types of trench width (60, 65 and 70 cm).

Two parallel cuts just in one go.

- Ø500 mm (20") blade guards available as optional. (Only for versions Honda 23Hp, Kohler 18Hp and Lombardini 16Hp).
- Two blade guards.
- Two water tanks.
- It can cut with just one blade, either on the right or the left side.
- Locking system of cutting depth.
- Cyclone air filter 13Hp Honda motor version.
- Oil level dipstick and oil drain plug.
- Parking brake.
- Hubcaps at front and rear wheels to protect the bearings.



TRENCHER 60/70



TIME SAVING AND INCREASED PRODUCTIVITY:



1 A single line needs to be drawn. This will be the guide for one of the two blades while cutting.



2 Following the drawn line, the machine will perform **two parallel cuts in one go** at the selected width.

COMPARING SINGLE CUT / DOUBLE CUT OF A 100 m TRENCH ON ASPHALT

Machine	Metres cut	Waiting time	Machine downtime	Fuel consumption	Cutting time used
COBRA 45	200 m to run for cutting two parallel lines of 100 m.	More than an hour of backhoe loader waiting time before start digging.	16 water refills needed.	Longer working time: higher fuel consumption.	2 hours y 40 min
TRENCHER	Only 100 m to run for cutting two parallel lines	No waiting time.	Only 12 water refills needed.	Less working time: lower fuel consumption.	2 hours y 5 min
	17,8 min less to perform the two cuts.	71 min waiting time saving for the backhoe loader.	17,2 min saved in the cutting process.	4% fuel saving.	35 min less time for every 100 metres cut.

	TRENCHER 60/70			
Item code	2579	2580	2581	2582
Motor type	4-stroke / Gasoline			4-stroke / Diesel
Model motor	Honda GX390 CYC	Honda GX630	Kohler CH620	Lombardini 25 LD
Motor starter	Recoil		Electric	
HP	13	23	18	16
Blade bore diameter (mm / in)	25,4 / 1"			
Max. blade diameter (mm / in)	400 / 14"			
Max. cutting depth (mm / in)	120 / 4,7"			
Water tank capacity (L. Gal.)	40 + 20 / 10,5 + 5,2			
Net weight (Kg. / lbs.)	140 / 309	161 / 355	144 / 317	229 / 505
Packaging dimensions L x W x H (mm / in)	1500 x 840 x 1180 / 59" x 33" x 46,4"			
Disc included	No			

HALCON Range

Power Trowels

The **HALCON** range includes four excellent power trowels, designed for a fast and perfect finishing of the concrete floors of any size.

The **HALCON 65** operates as a normal power trowel, but it also includes an upper stabilizing ring with rubber protected edges that allow the machine to operate very near to walls, kerbs and alike.

Since its size is not too big, it can work into houses and apartments, through the door hollow, without folding it previously.

The **HALCON 95** is a perfect power trowel for any concrete surface, no matter its size.

The protection ring is fully chromium plated and mounted on silent blocks. This contributes to a smooth operation and an easy cleaning and dry concrete riddance.

The blades pitch regulation is easy due to its retractable blades system.

The **HALCON 125** shares the features of **HALCON 95**, except for different size of the blades.

Finally, the **HALCON DUPLO** is a double self propelled power trowel. With mechanical transmission it operates on Ø90 cm. (36") rotors that turn inwards. It is suitable for both, preparing and finishing of fresh concrete surfaces.

Non-overlapper: the blades of each rotor do not interfere with the other rotor blades. This allows using floating discs and floating blades (optionally available).



HALCON 95



FEATURES AND BENEFITS OF THE HALCON RANGE



Die cast aluminium gearbox, with conical shaped bearings.



The triple tube arm is removable. Inside, the electric wiring and the accelerator.



Folding handle in **HALCON 65**.

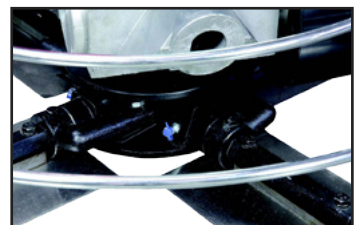

Blade holders include a lubricator nipple for an easier maintenance.

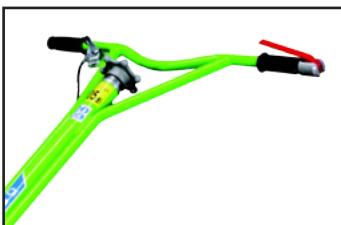

Blades pitch regulated by an ergonomic knob and a steel wire transmission.



Slot for transportation bar.



Protection ring fully chrome-plated.



Water tank included in **HALCON 95** and **HALCON 125**.

A perfect finishing.

- Chromium plated centrifugal clutch, ensuring the highest performance at high, medium and low engine revs.
- Emergency stop system ("dead-man release handle"), in accordance with EC safety regulations.
- **HALCON 95** and **HALCON 125** are the only two models in the market including a water tank controlled from the handlebar to sprinkle water into concrete when needed.
- Easy and accessible blades pitch regulation.

Special features for HALCON DUPLO:

- Water tank with submersible pump to sprinkle water.
- Safety handles for emergency stop.
- Three headlights.
- 23 Hp Honda motor with battery and electric starter.
- Adjustable seat position.



	HALCON 65			
		1 - PHASE	3 - PHASE	3 - PHASE
Item code	1886	1887	1889	1888
Motor type	4-stroke / Gasoline	230 V	230 - 400 V	230 - 400 V
Model motor (Hz)	Honda GX160	50 / 3	50 / 5	50 - 60 / 4
Motor starter	Recoil		Switch	
Kw (Hp)	4 (5,5)		1,5 (2)	
Blade diameter (mm / in)	60 / 23,6"			
Blades pitch regulation	Mechanical			
Blades R.P.M.	130			
Net weight (Kg. / lbs.)	62 / 137			
Packaging dimensions L x W x H (mm / in)	910 x 680 x 850 / 35,8" x 26,7" x 33,4"			
Blades included	Set of 4 finishing blades + floating disc			

	HALCON 95			
			3 - PHASE	
Item code	2031*	2032	2006	2007
Motor type	4-stroke / Gasoline		400 V	400 V
Model motor (Hz)	Honda GX160		50 / 4	50 / 5
Motor starter	Recoil		Electric	
Kw (Hp)	4 (5,5)		2,2 (3)	
Blade diameter (mm / in)	90 / 35,4"			
Blades pitch regulation	Mechanical			
Blades R.P.M.	130			
Net weight (Kg. / lbs.)	81,2 / 179			
Packaging dimensions L x W x H (mm / in)	1120 x 1100 x 950 / 44" x 43,3" x 37,4"			
Blades included	Set of 4 finishing blades			

*No CE

	HALCON 125		HALCON DUPLO
	2026	2027	2092
Motor type	4-stroke / Gasoline		4-stroke / Gasoline
Model motor (Hz)	Honda GX270	Honda GX390	Honda CX630
Motor starter	Recoil		Electric
Kw (Hp)	6,6 (9)	9,5 (13)	16,9 (23)
Blade diameter (mm / in)	120 / 47,2"		2 x 90 / 2 x 35,4"
Blades pitch regulation	Mechanical		Mechanical
Blades R.P.M.	130		130
Net weight (Kg. / lbs.)	113 / 249		312,4 / 689
Packaging dimensions L x W x H (mm / in)	1335 x 1310 x 950 / 52,5" x 51,5" x 37,4"		2160 x 1260 x 1500 / 85" X 49,6 x 59"
Blades included	Set of 5 finishing blades		Set of 8 finishing blades

DRILL 9

Core Drill Motor

- Three-position speed selector.
- Anti-shock electric safety system (PRCD wire)
- Mechanical friction clutch to release the motor in case of jammed core bit.
- Heat treated cogwheels for improved resistance.
- Connecting thread 1 1/4" UNC.
- Aluminium body and water inlet included.



	DRILL 9
	1 - PHASE
Item code	9320
Motor voltage (V)	230
Frequency (Hz / Plug)	50 / 60
Kw	3,5
Max. drilling diameter (mm / in)	452 / 18"
R.P.M. 1 st speed / 2 nd speed / 3 rd speed	300 / 600 / 900
Net weight (Kg. / lbs.)	13 / 28,6
Packaging dimensions (L x W x H (nm / in)	570 x 200 x 200 / 22,4" x 7,8" x 7,8"

RIG

Drill columns

- Two strong rig models available, both made of anodized aluminium with a tube core and featured with 2 rack tracks.
- 40 x 40 x 3 mm in **RIG 3** (1.6" x 1.6" x 0.11").
- 50 x 50 x 3 mm in **RIG 5** (1.6" x 1.6" x 0.11").
- Self adjusting wheels.
- Featured with a drill bit centering device.
- Tipping safe system in the base and the wheels.
- Prepared to use vacuum pump (only RIG 3).



	RIG 3	RIG 5
Item code	9340	9350
Max. drilling diameter (mm / in)	352 / 13,8"	452 / 18"
Speed reducer gearbox	No	Yes
Net weight (Kg. / lbs.)	22 / 48,5	24,6 / 54,2
Packaging dimensions (L x W x H (nm / in)	1110 x 330 x 450 / 43,7" x 13" x 17,7"	1110 x 380 x 450 / 43,7" x 15" x 17,7"

FEATURES AND BENEFITS OF THE RIG RANGE

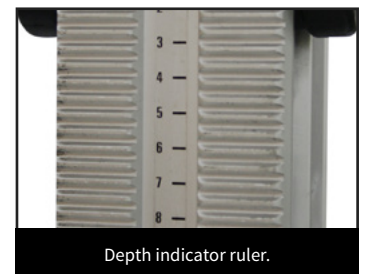
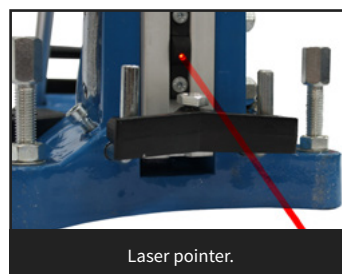

B50 I / C50 IB

Vacuum Cleaner - Dust and liquids

- This vacuum cleaner has multiple applications in the construction. It is a complement to milling machines, circular saws, wall chasers, angle grinders, polishers, drills, chop saws, etc.
- The stringent regulations on pollution and working safety makes virtually essential to us vacuum cleaners.
- It includes the different accessories for every application or work.
- Stainless steel tank.
- Three independent motors (3 x 1000 W) that can be either individually operated or all of them at the same time, to achieve the required suction power.



	B50I	C50IB
	1 - PHASE	1 - PHASE
Item code	8430	8440
Motor Voltage	230	230
Frequency (Hz / Plug)	50	50
Number of motors / W	2 x 1000	3 x 1000
Water basin capacity (Ltr. / Gal.)	77 / 20,3	77 / 20,3
Net weight (Kg. / lbs.)	24 / 52,9	30 / 66,1
Packaging dimensions L x W x H (mm / in)	690 x 600 x 1000 / 27,1" x 23,6" x 39,3"	

CAT 202

Scarifier

- Handwheel adjustable milling depth.
- Multiple applications: milling, grinding, flaking, grooving, etc. of small and medium surfaces of both, concrete and asphalt or any other hard material.
- The six-tips milling cutters are highly resistant, made of strong steel with up to 58/60 HRC hardness.
- Quick milling drum lifting system, to avoid accidents and ease the machine transportation.
- It is recommended to use it along a dust vacuum cleaner, that can be connected in the outlet designed for this purpose.



* Includes milling drum, cutters and washers.

	CAT 202		
		1 - PHASE	3 - PHASE
Item code	9715	9717	9718
Motor type	4-stroke / Gasoline	230 V	400 V
Model motor / Hz	Honda GX 200	50	50 / 60
Motor starter	Recoil	Switch	Switch
Kw (Hp)	4,75 (6,5)	2,2 - (3)	2,2 - (3)
Maximum operating width (mm / in)		189 / 7,4"	
Milling output (m ² / h. - ft ² / h.)		30 / 323	
Suction outlet (mm / in)		50 / 2"	
Net weight (Kg. / lbs.)	75 / 165		79 / 174
Packaging dimensions L x W x H (mm / in)		790 x 480 x 790 / 31,1" X 18,8" X 31,1"	

ACCESSORIES

Optional Accessories



R-0325151. Hour and RPM counter for the HALCON and COBRA ranges.



R971537000. Drum (mounting 80 milling cutters in four shafts) for CAT 202.



R-2501540. Vacuum Pump for the RIG range.

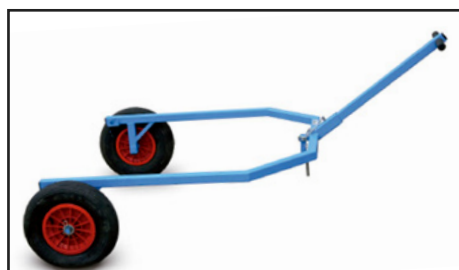

R209199040. Transport trolley for HALCON DUPLO.



R971599500. Set of 20 six-tips milling cutters (for one shaft only).

BLADES FOR THE HALCON RANGE



Models	HALCON 60	HALCON 65	HALCON 90	HALCON 95	HALCON 120 (4 pâles)	HALCON 125 (5 pâles)	HALCON DUPLO
Set of 4 finishing blades	n.a.		R201099001	R-0799067	R202099001	R-0799073	R-201099001
Set of 4 floating blades*	R-0799049	R-2032023	R201006000	R201006000	R202006000	R-0799070	R201006000
Floating	R188199004	R-2032024	R209199010	R-2032062	n.a.	R-0799071	R209199010

*Halcón 125 model with Set of 5 floating blades

OPTIONAL ACCESSORIES FOR THE RIG RANGE

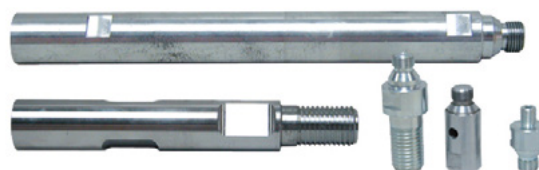

Models		
RIG 3 / 5	Adaptor 1-1/4" UNC to R1/2"	R - 2501511
	Extender 1-1/4" UNC x 200 mm	R - 2501507
	Extender 1-1/4" UNC x 300 mm	R - 2501508
	Extender 1-1/4" UNC x 500 mm	R - 2501509
	Extender R1/2" x 300 mm	R - 2501644

The COBRA VARIO project

Multiple cuts with multiple blades

Some of our customers have repeatedly demanded a floor cutting machine for specific needs, such as bevel cuts, close parallel cuts to dig narrow trenches for laying optic fibre or tactile lines in train stations or airports for visually impaired persons. Besides, the machine should still be fully operational for the most common use: cutting a line on the floor.

This project is currently running in SIMA. We expect to meet our customer needs and the new market requests.

Currently we are already able to supply customized solutions on demand, but keep moving forward to make of this project a new standard.

The approach is based on the **Mekano concept**, having the different models sharing most of their components, but each one with the specific features (blade size, motor type, power, etc.) to perfectly adapt to every request.

A long experience in pavement cutting makes SIMA to approach this innovative concept. **VARIO**: a concept for the future... today in SIMA.

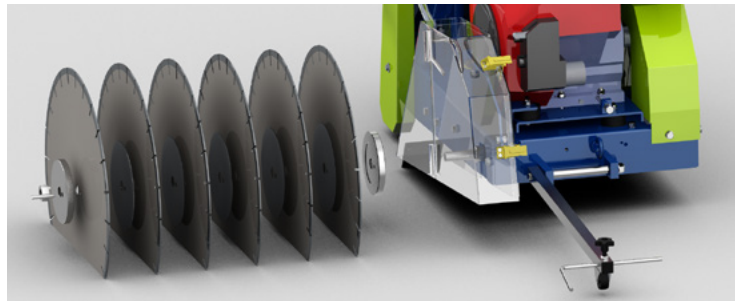
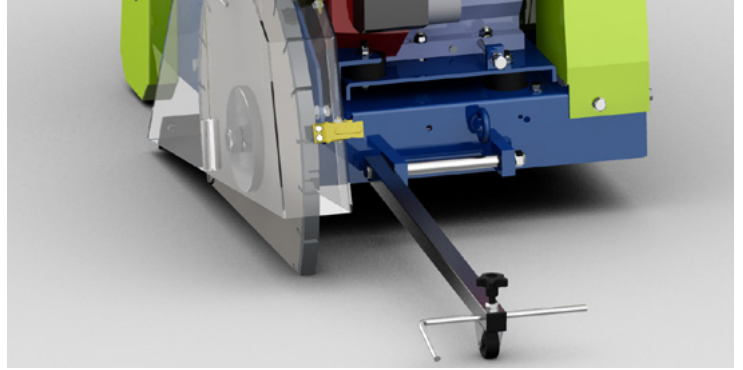

FOUR TYPES OF CUT

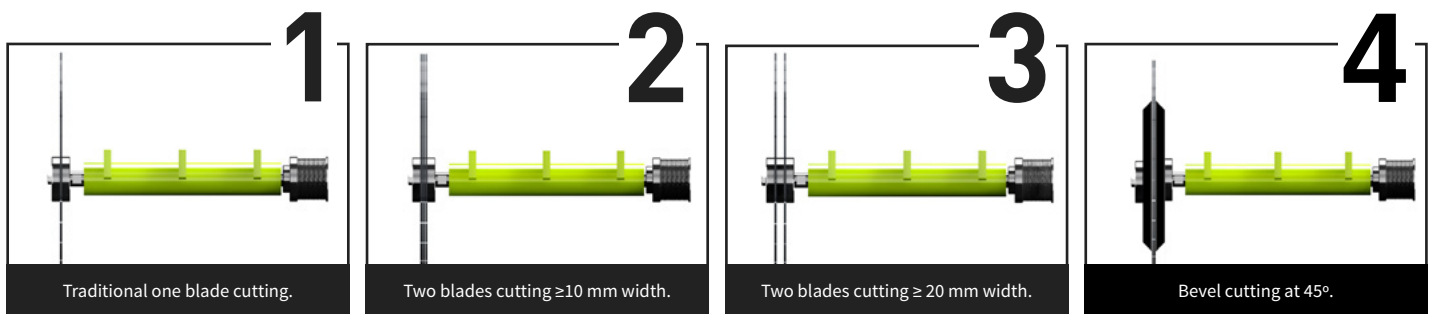

Steps for beveled cut at 45°:

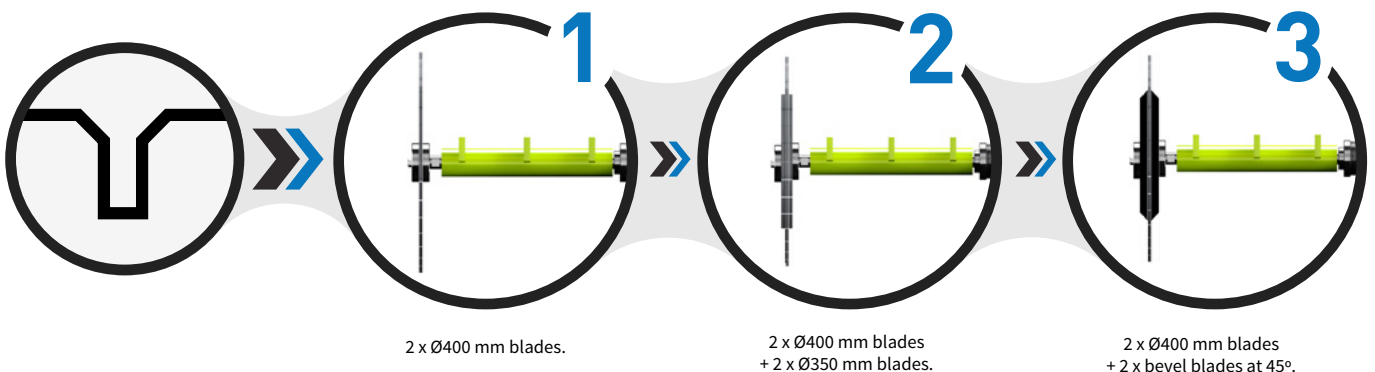

DIAMOND BLADES AND CORE DRILLS

- Diamond blades range
- SIMA PLUS Range
- SIMA PREMIUM Range
- Core Bits

5



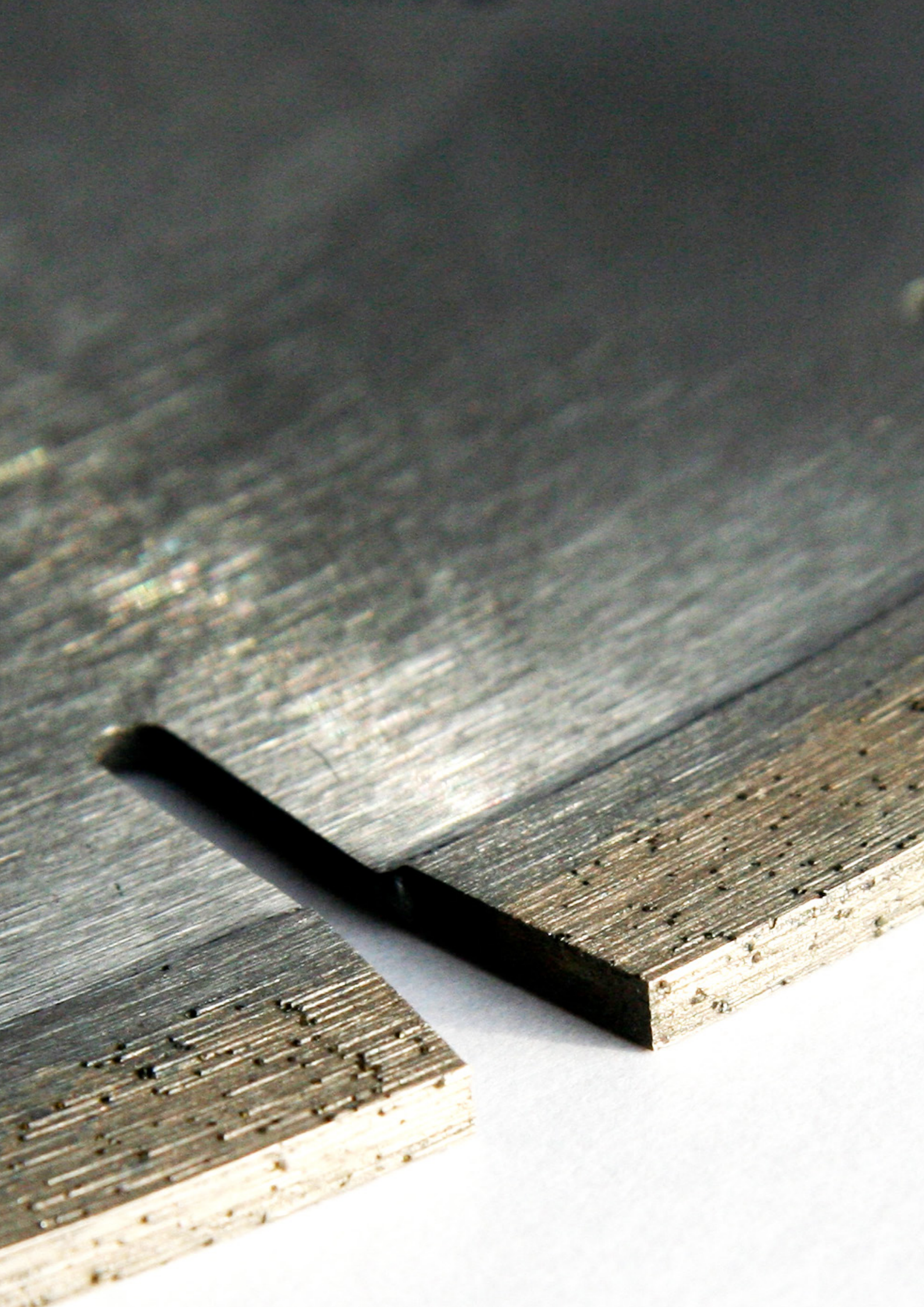

DIAMOND BLADES

SIMA has a longstanding experience in diamond blades, both as a natural complement to our machines and as a product traded under SIMA brand.

For more than 20 years we have evolved to the market requirements, and currently offer two quality levels according to each customer needs.

The technologies in the diamond blade manufacturing:

A diamond blade is made of a body or core of high precision steel to which cutting segments are added.

These segment are made of a mix of metal powder (a combination of different elements, such as cobalt, tungsten, zinc, iron, etc.) and a resin to make the bond.

This mixture is also combined with diamonds of different size and hardness, and in a certain concentration. Finally, it is shaped as a blade segment in which the composition of the metal powder and the size and concentration of diamonds has been chosen accordingly with the kind of material that it will be cut.

The result is later put through a thermic process to transform it into a metallic segment, hard, and very resistant.

SIMA technicians consider all the needful variables when recommending the blade that best adapts to every specific cut.



DIAMOND BLADES AND DRILLING CORE BITS

Three types of segment welding.



1

Sinter welding: this welding joints the segments to the blade body by high pressures and temperatures.



2

Silver bracket welding: A silver wire bracket is used to weld both parts, segment and body, in a protective air-pocket.



3

Laser welding: Is the safest and most accurate welding. It requires a state of the art technology and a higher quality of the materials to weld: segments and blade body.

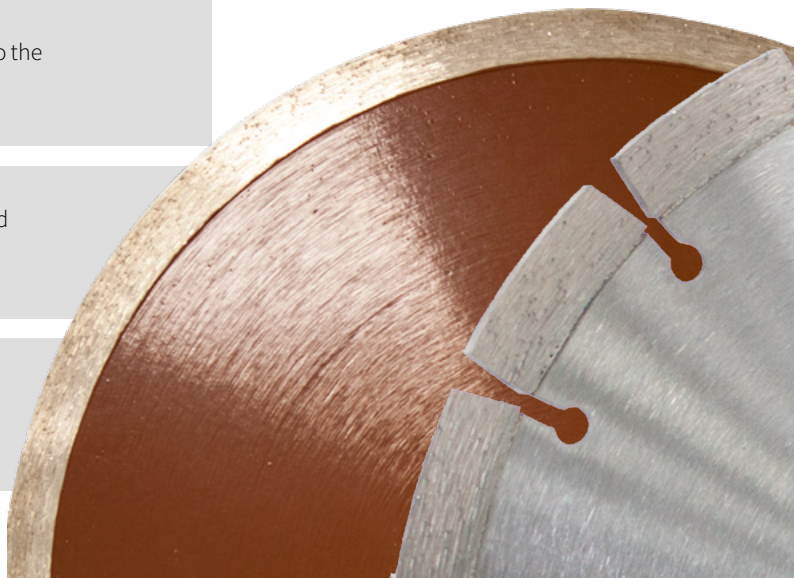

Choosing a Diamond blade:

As a general rule, it can be said that cutting soft or very abrasive materials is a job for a hard metal and a lower diamonds concentration segment. For a hard material, the segment needs to be made of a softer metal bond and bigger sized diamonds. But each case must be carefully analyzed to achieve the right balance for the best possible cut.

The same material may have a slightly different composition. For instance, marble, according to its origin (Carrara, Sweedish, Vermont, etc.); or the granite (Alkai, Tonalite, Binary, Riolite, etc.); even concrete, depending on the aggregates used in its composition (sand, gravel, stone, recycled concrete, etc.)

As a result, even on namely the same material, the blade performance can be different depending on the its specific composition and the abrasiveness linked to it.

For our customer, the decision is not as hard as it seems: he just need to tell us what material he needs cutting, what machines he will be using to cut and the blade diameter.

SIMA DIAMANT offers two blade ranges: **PLUS series** and **PREMIUM series**. The choice will depend on the required performance: the **PREMIUM** blades feature a higher segment.

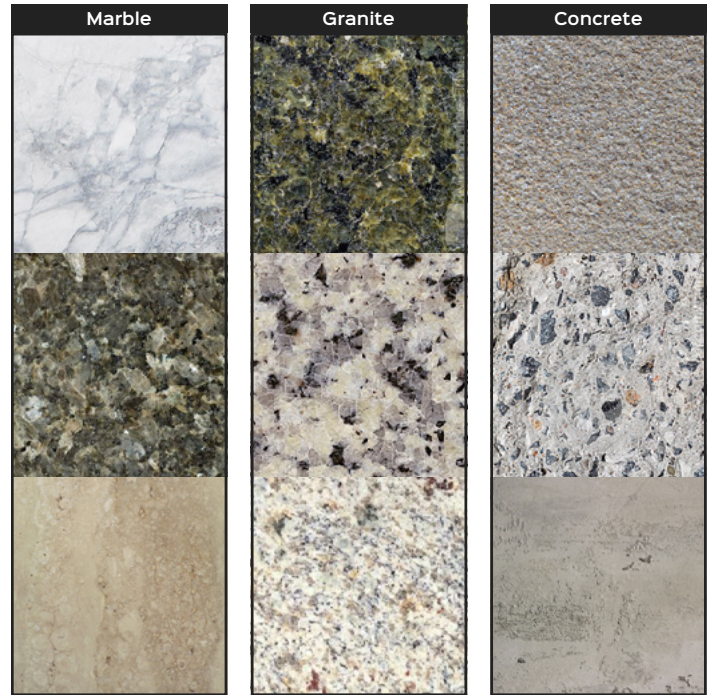

Dry cutting	Wet cutting
	
<p>A cutting disc runs at a very high speed, the friction heating the blade. Therefore, the blade quality must be high enough to resist the overheating while keeping the cutting capacity.</p> <p>When dry cutting, it is better to perform short intermitent cuts, to let the blade cool down during the breaks. It is very important to not pushing the blade hard on the material to speed up the cutting: this may lead to reduce the blade life and performance and damage the machine motor.</p>	<p>Every disc performance is enhanced by cooling the blade in the cutting point.</p> <p>On dry cutting, cooling is done by the air displaced by the blade rotation. On wet cutting, cooling is done with liquid (typically water), which is more efficient and allows a faster cutting.</p>

Blade types according to its segment:



A **segmented disc** is mostly recommended to cut hard materials, such as stone, granite, bricks, etc.) when a very high cutting precision is not essential and speed is.



A **turbo disc** improves the cutting precision in those materials that are subject to be chipped, providing a neater cut at a reasonable speed.



A **continuous rim blade** is perfect for ceramic materials requiring cutting accuracy and a very clean cut.



SIMA PLUS Range

The perfect value for money

The **SIMA PLUS** blades encompass a professional range offered at a competitive price: high quality cutting solutions for the most frequently used construction materials.

<Ø250 bore: Ø22,2 mm
≥Ø250 bore: Ø25,4 mm

GENERAL PURPOSE

- One blade to cut different materials: bricks, concrete, granite, tiles, ceramics, etc.

GENERAL PURPOSE X - COOL

- For cutting all kind of materials: its ventilated plate improves the blade cooling and reduces vibrations.

GENERAL PURPOSE

PLUS RANGE

Item code	R - 650115	R - 6501125	R - 6501180	R - 6501230	R - 6206300	R - 6206350
Blade diameter (mm / in)	Ø115 / 4"	Ø125 / 5"	Ø180 / 7"	Ø230 / 9"	Ø300 / 12"	Ø350 / 14"
Segment height (mm / in)	9 - 2/6"			7 - 9/3"		
Cutting mode	Dry			Dry / Wet		
Machine	Angle grinder			Angle grinder / Table saw		Table Saw / Power cutters

TURBO GENERAL PURPOSE

PLUS RANGE

Item code	R - 6206400	R - 6206500	R - 6206700*	R - 6134700**	R - 6206000
Blade diameter (mm / in)	Ø400 / 16"	Ø500 / 20"	Ø700 / 27"	Ø700 / 27"	Ø1000 / 39"
Segment height (mm / in)	7 - 9/3"				
Cutting mode	Wet				
Machine	Table saw				

* Special Ø60 mm bore for Magnum 700

** Special Ø25.4 mm bore for BALI 700

TURBO SLIM - GENERAL PURPOSE

- For cutting all kind of materials with a good finishing: terrazzo, concrete, clay blocks, bricks, etc.

TURBO SLIM - GENERAL PURPOSE

PLUS RANGE

Item code	R - 6601115	R - 6601125	R - 6601180	R - 6601230	R - 6601250	R - 6601300
Blade diameter (mm / in)	Ø115 / 4"	Ø125 / 5"	Ø200 / 7"	Ø230 / 9"	Ø250 / 10"	Ø300 / 12"
Segment height (mm / in)	7,5 - 16"					
Cutting mode	Dry		Dry / Wet		Wet	
Machine	Angle grinder		Angle grinder / Table saw		Table saw	Table saw / Power cutters

GRANITE - HARD STONE

- For cutting hard natural stone: granite, basalt, quartz, silica, etc.

GRANITE - HARD STONE

PLUS RANGE

Item code	R - 6502115	R - 6502125	R - 6502230	R - 6502300	R - 6502350	
Blade diameter (mm / in)	Ø115 / 4 1/2"	Ø125 / 5"	Ø230 / 9"	Ø300 / 12"	Ø350 / 14"	
Segment height (mm / in)	10 - 3/8"					
Cutting mode	Dry			Dry / Wet		
Machine	Angle grinder			Angle grinder / Table saw		Table saw / Power cutters

SANDSTONE

- Sandstone and all kind of abrasive materials.

MARBLE - LIMESTONE

- For cutting marble and limestone: steps, window sills, baseboards, flower boxes, etc.



	SANDSTONE		MARBLE - LIMESTONE	
	PLUS RANGE		PLUS RANGE	
Item code	R - 6504230	R - 6205300	R - 6205350	R - 6205400
Blade diameter (mm / in)	Ø230 / 9"	Ø300 / 12"	Ø350 / 14"	Ø400 / 16"
Segment height (mm / in)	9 - 2/6"		7 - 9/3"	
Cutting mode	Dry / Wet		Dry / Wet	
Machine	Angle grinder / Table saw		Table saw / Power cutters	

CERAMIC - GLAZED TILES

- For a perfect cutting fresh on all kind of ceramic materials: gres, glazed tiles, porcelaine, etc.

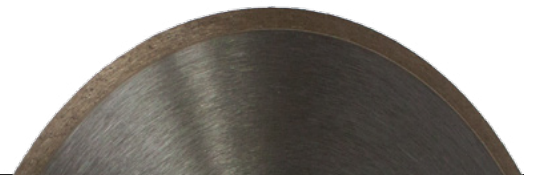

	CERAMIC - GLAZED TILES				
	PLUS RANGE				
Item code	R - 6302180	R - 6302200	R - 6302230	R - 6302250	R - 6302300
Blade diameter (mm / in)	Ø180 / 6"	Ø200 / 7"	Ø230 / 9"	Ø250 / 10"	Ø300 / 12"
Segment height (mm / in)	7 - 9/3"				
Cutting mode	Dry		Dry / Wet		
Machine	Angle grinder	Angle grinder / Table saw		Table saw	Table saw / Power cutters

GREEN CONCRETE

- For cutting concrete and other abrasive construction materials: refractory brick, precast concrete, concrete blocks, etc.
- Especially designed for expansion joints, silico-calcareous concrete and abrasive floors.

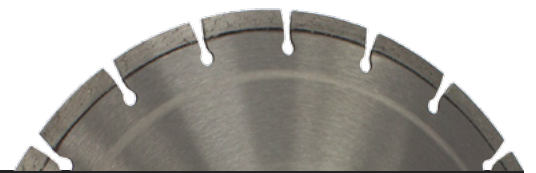

	GREEN CONCRETE					
	PLUS RANGE					
Item code	R - 6203300	R - 6203350	R - 6203400	R - 6203450	R - 6203500	R - 6203600
Blade diameter (mm / in)	Ø300 / 12"	Ø350 / 14"	Ø400 / 16"	Ø450 / 18"	Ø500 / 20"	Ø600 / 24"
Segment height (mm / in)	7 - 9/3"					
Cutting mode	Dry / Wet			Wet		
Machine	Floor cutter / Table saw / Power cutters			Floor cutter / Table saw		

HARD CONCRETE

- For cutting old concrete, concrete blocks, asphalt and precast concrete.

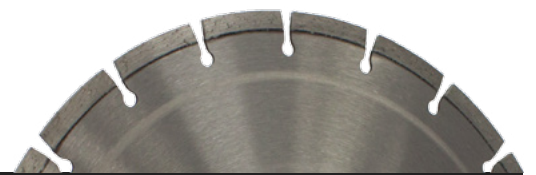

	HARD CONCRETE						
	PLUS RANGE						
Item code	R - 62073300	R - 6207350	R - 6207400	R - 6207450	R - 6207500	R - 6207600	R - 6207700
Blade diameter (mm / in)	Ø300 / 12"	Ø350 / 14"	Ø400 / 16"	Ø450 / 18"	Ø500 / 20"	Ø600 / 24"	Ø700 / 27"
Segment height (mm / in)	7 - 9/3"						
Cutting mode	Dry / Wet			Wet			
Machine	Floor cutter / Table saw / Power cutters			Floor cutter / Table saw			

SIMA PREMIUM Range

High Performance

SIMA PREMIUM range offers the highest performance in construction materials cutting. With a higher segment their extended life makes them suitable for very accurate professional jobs.

<Ø250 bore: Ø22,2 mm
>Ø250 bore: Ø25,4 mm

GENERAL PURPOSE

- This blade can be used for an efficient cutting on different materials: bricks, concrete, granite, tiles, ceramics, etc.

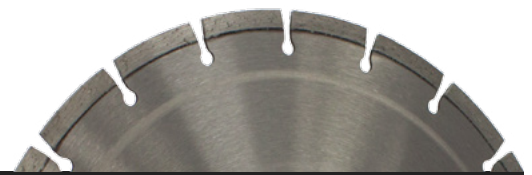

	GENERAL PURPOSE				
	PREMIUM RANGE				
Item code	D - 6022300	D - 6022350	D - 6022400	D - 6022500	D - 6022000
Blade diameter (mm / in)	Ø300 / 12"	Ø350 / 14"	Ø400 / 16"	Ø500 / 20"	Ø1000 / 39"
Segment height (mm / in)	12 / 1/2"				
Cutting mode	Dry / Wet			Wet	
Machine	Table saw / Power cutters			Table saw	

TURBO - GENERAL PURPOSE

- A turbo multipurpose blade for cutting quartz, silestone, porcelaine, granite, hard natural stone (basalt, silica, etc) and other hard and compact materials.



	TURBO - GENERAL PURPOSE
	PREMIUM RANGE
Item code	D - 6602230
Blade diameter (mm / in)	Ø230 / 9"
Segment height (mm / in)	12 / 1/2"
Cutting mode	Dry / Wet
Machine	Angle grinder / Table saw

GRANITE - HIGH PERFORMANCE

- For cutting natural stone: granite, basalt, quartz, silica, silestone, etc.



	GRANITE - HIGH PERFORMANCE				
	PREMIUM RANGE				
Item code	D - 6041230	D - 6042300	D - 6042350	D - 6042400	D - 6042500
Blade diameter (mm / in)	Ø230 / 9"	Ø300 / 12"	Ø350 / 14"	Ø400 / 16"	Ø500 / 20"
Segment height (mm / in)	12 - 1/2"				
Cutting mode	Dry / Wet			Wet	
Machine	Angle grinder / Table saw	Table saw / Power cutters		Table saw	

MARBLE ELECTROPLATED

- Professional use of marble specialists and builders.
- Not suitable for other materials.



	MARBLE ELECTROPLATED			
	PREMIUM RANGE			
Item code	D - 6061115	D - 6061125	D - 6061180	D - 6061230
Blade diameter (mm / in)	Ø115 / 4"	Ø125 / 5"	Ø180 / 7"	Ø230 / 9"
Segment height (mm / in)	5 - 3/16"			
Cutting mode	Dry			
Machine	Angle grinder			

CERAMIC - VITRIFIED MATERIALS

- It cuts vitrified materials and hard porcelain materials.
- Central flange to allow angle cuts.



	CERAMIC - VITRIFIED MATERIALS	
	PREMIUM RANGE	
Item code	D - 6081301	D - 6081350
Blade diameter (mm / in)	Ø300 / 12"	Ø350 / 14"
Segment height (mm / in)	10 - 3/8"	
Cutting mode	Wet	
Machine	Table saw	

TURBO CERAMIC - PROFESSIONAL

- For cutting ceramic materials, porcelain and artificial stone.



	TURBO CERAMIC - PROFESSIONAL
	PREMIUM RANGE
Item code	D - 6081300
Blade diameter (mm / in)	Ø300 / 12"
Segment height (mm / in)	10 - 3/8"
Cutting mode	Wet
Machine	Table saw

CERAMIC EXTRA SLIM

- The finest cut on all type of ceramic dry cuts.
- Perfect for refurbishing jobs and the installation of self-ventilated façades needing a thin and accurate cut without chipping.



	CERAMIC EXTRA SLIM	
	PREMIUM RANGE	
Item code	D - 6121115	D - 6121125
Blade diameter (mm / in)	Ø115 / 4"	Ø125 / 5"
Segment height (mm / in)	12 - 1/2"	
Cutting mode	Dry	
Machine	Angle grinder	

CONCRETE - HIGH PERFORMANCE

- For concrete cutting using power cut - off saws.
- It cuts concrete blocks, but also pipes, kerbstones, and abrasive construction materials.

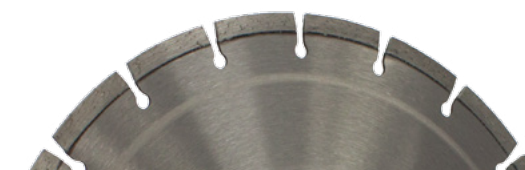

CONCRETE - HIGH PERFORMANCE		
PREMIUM RANGE		
Item code	D - 6091300	D - 6091350
Blade diameter (mm / in)	Ø300 / 12"	Ø350 / 14"
Segment height (mm / in)	12 - 12"	
Cutting mode	Dry / Wet	
Machine	Power cutters	

ASPHALT

- A perfect blade for rentals: excellent performance on all type of floors, asphalt, concrete with either lime or silica aggregates and fresh or old concrete.



ASPHALT						
PREMIUM RANGE						
Item code	D - 6133300	D - 6133350	D - 6133400	D - 6133450	D - 6133500	D - 6133600
Blade diameter (mm / in)	Ø300 / 12"	Ø350 / 14"	Ø400 / 16"	Ø450 / 18"	Ø500 / 20"	Ø600 / 24"
Segment height (mm / in)	12 - 12"					
Cutting mode	Wet					
Machine	Floor cutter / Power cutters			Floor cutter		

GREEN CONCRETE - HIGH PERFORMANCE

- Especially suitable for volcanic aggregates, basalt, lignite. Good performance on Asphalt.



GREEN CONCRETE - HIGH PERFORMANCE						
PREMIUM RANGE						
Item code	D - 6153300	D - 6153350	D - 6153400	D - 6153450	D - 6153500	D - 6153600
Blade diameter (mm / in)	Ø300 / 12"	Ø350 / 14"	Ø400 / 16"	Ø450 / 18"	Ø500 / 20"	Ø600 / 24"
Segment height (mm / in)	12 - 12"					
Cutting mode	Wet					
Machine	Floor cutter					

HARD CONCRETE - HIGH PERFORMANCE

- For intensive cutting of hard concrete, highly abrasive concrete and concrete blocks.



OLD CONCRETE - HIGH PERFORMANCE					
PREMIUM RANGE					
Item code	D - 6163300	D - 6163350	D - 6163400	D - 6163450	D - 6163500
Blade diameter (mm / in)	Ø300 / 12"	Ø350 / 14"	Ø400 / 16"	Ø450 / 18"	Ø500 / 20"
Segment height (mm / in)	12 - 12"				
Cutting mode	Dry / Wet			Wet	
Machine	Floor cutter / Power cutters			Floor cutter / Table saw	

Diamond blades and core bits

	GAMME PLUS								GAMME PREMIUM										
	General purpose	Turbo Slim - General purpose	Granite - Hard Stone	Sandstone	Marble - Limestone	Ceramic - Glazed Tiles	Green Concrete	Hard Concrete	General purpose	Granite - High performance	Marble Electroplated	Turbo - General purpose	Ceramic - Vitrified Materials	Turbo ceramic - professional	Ceramic extra slim	Concrete - High performance	Asphalt	Green concrete - High performance	Hard concrete - High performance
General Purpose	●	●	●	●	●	●	●	●	●	●	●	●		●			●	●	●
Concrete Blocks		●			●	●	●		●	●	●	●		●		●	●	●	●
Bricks	●	●	●	●	●		●	●	●	●	●			●		●	●	●	●
Thermoargile	●	●	●	●	●		●	●		●	●			●				●	●
Tuile	●	●	●	●	●		●		●		●			●		●	●		●
Grès		●		●	●	●	●	●	●	●	●	●		●		●	●	●	●
Ferrogres	●		●	●		●		●	●	●	●			●		●	●	●	●
Klinker	●	●	●	●		●		●		●	●			●		●	●	●	●
Granito	●	●	●	●	●	●	●		●		●	●		●		●	●	●	●
Porcelaine		●			●	●	●		●	●	●	●		●			●		
Céramique		●		●	●	●	●		●	●	●			●			●		
Ciment	●	●		●	●	●	●	●	●	●	●			●		●	●	●	●
Béton	●	●		●	●	●	●	●	●	●	●			●		●	●	●	●
Béton vieux	●	●		●	●	●		●		●	●	●		●		●	●	●	●
Granit	●	●	●	●	●	●		●		●	●	●		●		●	●	●	●
Ardoise	●	●	●	●	●	●	●	●	●	●	●	●	●	●	●	●	●	●	●
Marbre		●			●		●				●				●				
Calcaire		●			●		●			●	●	●	●	●			●		
Grès	●	●	●		●	●	●	●	●	●			●		●	●	●	●	●

Excellent ●

Good ●

Fair ●

Not suitable ●

CORE DRILLS

A **CORE DRILL** is made of two elements: the steel frame with its coupling nut and the diamant segments (a mixture of diamonds and a metal bond).

The segments can be welded on the frame with silver wire braces or by laser. A laser welding is the strongest and more accurate. It is performed using a very advanced technology, requiring a very high quality in the materials to weld, both the segment and the metal body of the core drill (the frame).

DIAMOND drilling allows very accurate drilling and without chipping the materials. It can be done vertically or horizontally, and also slanted.

In any case, core drilling will reduce the drilling total time. Whether to use dry or wet drilling depends on the type of material and the depth to be reached. In materials such as concrete (reinforced or otherwise), a wet drilling (with water) is strongly recommended. Wet drilling typically will be faster and will extend the segments life.

For small drilling jobs it is possible to use dry drilling. But it will eat the segment faster and perform a slower drilling.



CORE BITS different sizes



FEATURES AND BENEFITS OF SIMA CORE BITS

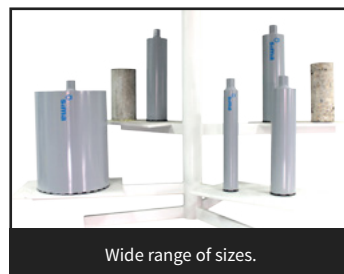
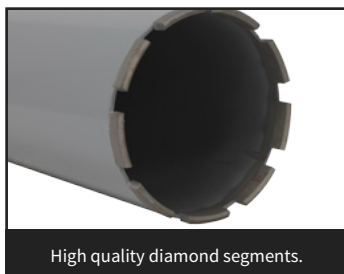

ADVANTAGES OF DIAMOND CORE DRILLING:



1

Suitable for any material: the wet core drill perforation suits all kind of materials, including green and hard reinforced concrete.



2

Cutting in a single pass: it can drill on concrete and steel simultaneously, without needing to change the core bit.



3

Low vibrations: it is perfect for drilling works near places with noise restrictions (hospitals, schools, etc.)



4

More efficient: the drilling is focused on the precise area that needs drilling. It cuts in circles, leaving a sample filling in the middle.



Uses.

- Intensive drilling on highly abrasive hard or green old or reinforced concrete.
- In pipes holes (water, gas, electricity pipes) and all kind of circular hole (air conditioning or heating, placing electric boards, opening windows and doors, extracting samples (concrete, asphalt), gas extraction or air ventilation pipes, etc.
- Good performance on asphalt drilling.



CORE DRILLS

Item code	D - 7150052	D - 7150062	D - 7150072	D - 7150082	D - 7150092	D - 7150102	D - 7150112	D - 7150122
Blade diameter (mm / in)	Ø52 - 2 3/8"	Ø62 - 2 7/8"	Ø72 - 2 5/8"	Ø82 - 3 1/8"	Ø92 - 3 5/8"	Ø102 - 4 1/8"	Ø112 - 4 1/2"	Ø122 - 4 5/8"
Segment height (mm / in)	8 - 5/16"							
Connection thread	1 1/4" UNC							
Cutting mode	Wet							
Machine	Drill							

CORE DRILLS

Item code	D - 7150132	D - 7150152	D - 7150162	D - 7150177	D - 7150202	D - 7150225	D - 7150252	D - 7150302	D - 7150352
Blade diameter (mm / in)	Ø132 / 5 1/8"	Ø152 / 6 5/8"	Ø162 / 6 3/8"	Ø177 / 6 3/4"	Ø202 / 7 6/8"	Ø225 / 8 5/8"	Ø252 / 9 5/8"	Ø302 / 11 5/8"	Ø350 / 13 2/3"
Segment height (mm / in)	8 - 5/16"								
Connection thread	1 1/4" UNC								
Cutting mode	Wet								
Machine	Drill								

Lined area for notes, consisting of multiple horizontal dotted lines.

Distributor:



SIMA, S.A.

Pol. Juncaril, C/ Albuñol, Parc. 250
18220 Albolote, Granada (Spain).
Tel. +34 958 490 410 - Fax. +34 958 466 645
www.simasa.com - info@simasa.com

