



Vispa 35 E-B-BS

**The revolutionary scrubbing machine for single-pass scrubbing,
drying and sanitising. Ideal for small areas
With 35 cm working width**

COMAC
professional people



Vispa 35 E-B-BS
Automated cleaning systems
for small areas

Vispa 35 E-B-BS. Ideal to replace manual cleaning systems in small and congested areas. Ideal for maintenance cleaning

Vispa 35 can be supplied battery or mains-powered in the scrubbing version and battery-powered in the sweeping version. The battery-powered version is cable-free for best manoeuvrability in small and congested areas.

Vispa 35 is supplied complete with brushes or pad holder. The battery-powered version comes with built-in battery charger and gel batteries as standard equipment. On request, the mains-powered version can be supplied with 15 m cable.



180° flexibility



Vispa 35 E



Vispa 35 B



Vispa 35 BS



Vispa 35 E-B-BS. Higher productivity of the operator and amazing cleaning performance

With Vispa 35 dirt is completely collected in the recovery tank and not smeared on the floor as it could be the case with traditional manual cleaning systems. Every cleaning task becomes much easier. Effortless scrubbing ensures much higher productivity of the

operator at the end of the working day. Thanks to the automatic squeegee and brush adjusting system, the machine can automatically adjust to any type of floor.

The best hygiene



Vispa 35 B-BS

Vispa 35 E

Dirt is collected in the recovery tank which is easily removed for effort-less emptying

The only scrubbing machine which ensures perfect scrubbing and drying also on bends without having to keep on a straight track

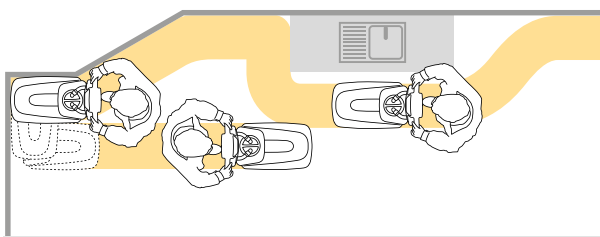

Parabolic squeegee

Thanks to the combined action of the suction motor and the squeegee swinging around the brush, perfect drying is ensured also on bends.



Uniform cleaning path

The relief valve on the solution tank cap ensures constant water outflow on the floor



Vispa 35 is the only small size scrubbing machine that ensures problem-free cleaning around corners and along walls

Vispa 35 is ideal for accurate cleaning of room corners and to operate in congested areas thanks to its handle

bar which ensures 180° flexibility and to its compact size that is shaped around the brush head.

Vispa 35 BS, the sweeping version with cylindrical brushes, can collect also small solid debris

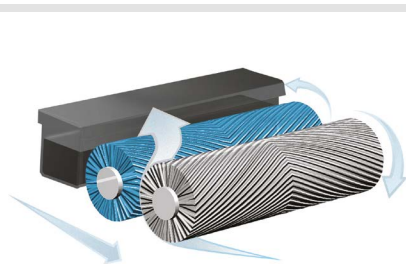

Vispa 35 BS
The hopper is really easy to pull out to empty all the small debris that have been collected

Vispa 35 BS
Easy cleaning of the debris hopper

Vispa 35 BS thanks to the design of the solution tank with a very low barycentre, can scrub also under shelves and modules at 35 cm from the floor.

Thanks to its front squeegee, Vispa 35 BS ensures drying even when reversing

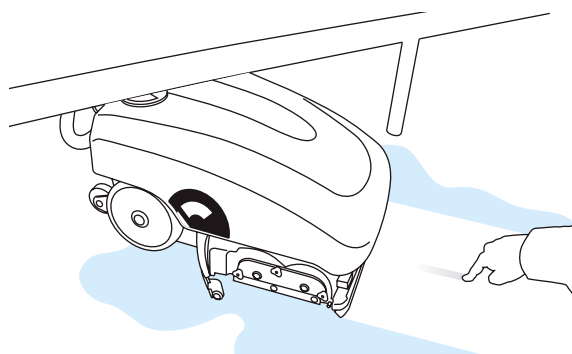
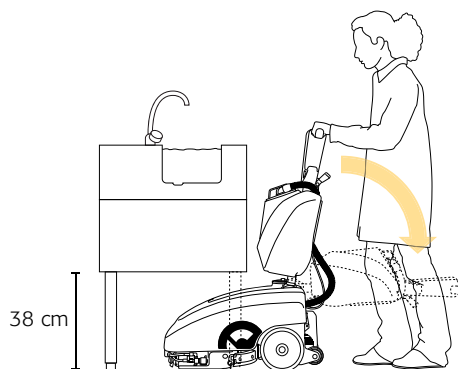



Vispa 35 E-B-BS, a small size floor scrubbing machine with endless operating autonomy

Vispa 35 B-BS is perfect for cleaning highly congested areas and its long run time is ensured by easy battery replacement and best machine efficiency over several cleaning sessions.

Furthermore, excellent run time is also ensured by tank capacity. The mains-powered version is ideal for cleaning small areas without too many obstacles and it provides endless run time thanks to the cable.

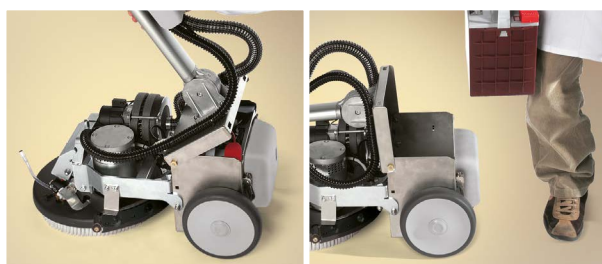

Vispa 35 B - Bs
The battery compartment is easily accessible for quick battery replacement



Vispa 35 E
The practical hook can be used as cable clamp when the machine is operating or, otherwise, as cable holder (on request, 15 m extension cable is also available as optional extra)

Vispa 35 E-B-BS. User-friendly, self-explanatory to use, to park and to recharge

Vispa 35 E-B-BS is user-friendly: just fill up the solution tank with water and detergent, fit the brushes and lower the squeegee to start operating.

Vispa 35 E-B is extremely compact in size and can be parked also vertically.



12V/8A built-in battery charger

Vispa 35 B-BS comes with a built-in battery charger and for recharging you just have to plug the battery charger cable into any mains socket

Vispa 35 E

Vispa 35 B

88,5 cm

79,4 cm



42,5 cm

43,7 cm

N.B.: On the battery-powered version, this operation is only allowed with the gel batteries that are supplied with the machine.

Vispa 35 E-B-Bs. Simple and quick cleaning of the machine after use

Thanks to quick cleaning procedures at the end of the day, perfect machine efficiency is ensured over time.



Vispa 35 E-B-BS
Simple and practical thorough cleaning of the suction filter

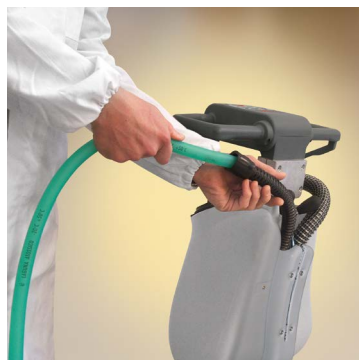

Vispa 35 B-BS
Periodic cleaning of the squeegee hose to ensure efficient suction

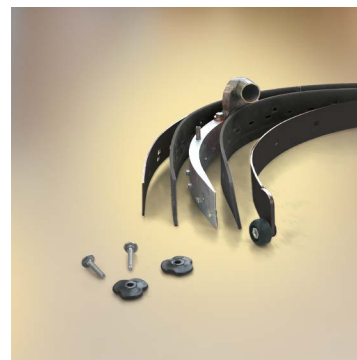

Vispa 35 E-B-BS
In order to ensure excellent drying performance, the squeegee rubbers should be kept always clean. When worn out, they are very easy to replace

TECHNICAL DESCRIPTION		Vispa 35 E	Vispa 35 B	Vispa 35 BS
Squeegee width	mm	440	440	525
Brush Ø	mm	355	355	110x335
Brush rpm	rpm	140	140	450
Brush motor	V/Hz - V/W	220-230/50 - 370	12/360	12/360
Suction motor	V/Hz - V/W	220-230/50 - 220	12/250	12/250
Max gradient at full load	%	2	2	2
Battery	V/Ah C5	-	12/60	12/60
Battery compartment dimensions (L x h x w)	mm	-	286x240x174	286x240x174
Battery weight	kg	-	25	25

	Working width mm	Brushes pressure	Power supply V/ traction	Voltage V/ Frequency Hz/ traction	Solution tank l up to	Recovery tank l up to	Working width up to m ² /h	Machine dimensions mm L x H x W	Machine weight kg (without batteries)
Vispa 35 E	355	17,7	-/semi aut.	220-230/50 110/60 semi aut.	8	10	830	620 1050 440	35
Vispa 35 B	355	20	12/semi aut.	-	10	10	1000	682 1018 440	42 (without battery) 67 (with battery)
Vispa 35 BS	335	14,5	12/semi aut.	-	10	10	1010	718 1105 460	42 (without battery) 67 (with battery)



KEY WORDS:

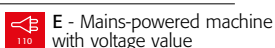
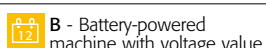
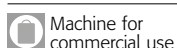

COMAC spa
Via Maestri del Lavoro, 13
37059 Santa Maria di Zevio - Verona - Italy
Tel. +39 045 8774222 - Fax +39 045 8750303
on line: www.comac.it - e-mail: com@comac.it