

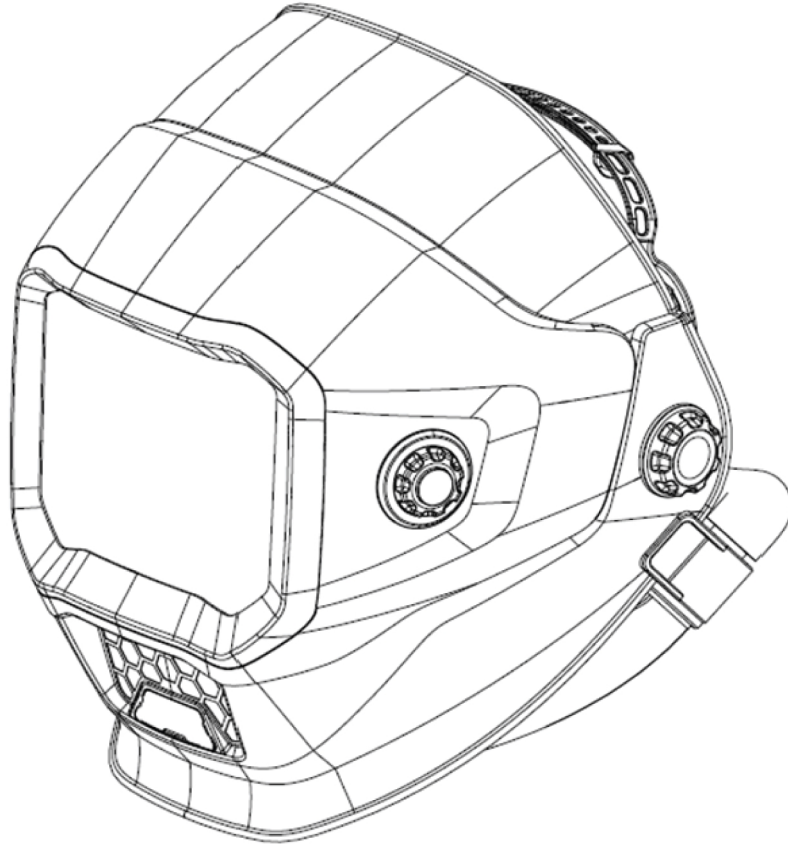

Sentinel A70 Air PRO



PAPR-Ready Auto Darkening Welding Helmet

Instruction manual and Spare parts list

PLEASE READ AND UNDERSTAND ALL INSTRUCTION BEFORE USE. RETAIN THIS MANUAL FOR FUTURE REFERENCE.

Complete User Manual at:

Manual Number: 0448 889 001
Revision Date: 2026-01-16
Revision Number: A
Language: English UK





EU DECLARATION OF CONFORMITY

According to the Council Directive (EU) 2016/425 entering into force 9 March 2016
This declaration of conformity is issued under the sole responsibility of the manufacturer.

Type of equipment

Welding Helmet

Type designation

Sentinel A70PRO 0700900700

Sentinel A70AIR PRO 0700900701

Brand name or trademark

ESAB

Manufacturer or his authorized representative established within the EEA**Name, address, and telephone No:**

ESAB AB

Lindholmsallén 9, Box 8004

402 77 Gothenburg, Sweden

Phone: +46 (0) 31 50 90 00

The following harmonized standard in force within the EEA has been used in the design:

EN ISO 16321-1:2022 – Eye and face protection for occupational use – Part 1: General requirements

EN ISO 16321-2:2021 – Eye and face protection for occupational use – Part 2: Additional requirements for protectors used during welding and related techniques

EN 12941:2023 Respiratory protective devices. Powered filtering devices incorporating a loose-fitting respiratory interface – Requirements, testing, marking

EC Type Examination Certificate and Test Certificates issued by:

ECS GmbH – European Certification Service

RILSA – Research Institute for Labor and Social Affairs

Hüttfeldstrasse 50

Jeruzalémská 1283/9

73430 Aalen, Germany

Czech Republic

Notified body number 1883

Notified body number 1024

performed and issued the EU type-examination certificates C4441.1ESAB, C4451.1ESAB, C4452.1ESAB, C4453.1ESAB, C4454.1ESAB, 1024/E-063/2025

By signing this document, the undersigned declares as manufacturer, or the manufacturer's authorized representative, that the equipment in question complies with the safety requirements stated above.

Date

Signature

Position

2026-01-15

Peter Burchfield

General Manager/Eq. Solutions

CE 2026

TABLE OF CONTENTS

1	SAFETY	4
1.1	Meaning of symbols	4
1.2	Safety instructions for auto-darkening welding helmet and filter	4
1.3	Safety precautions	5
1.4	California proposition 65 warning	9
1.5	Regulatory information	9
2	INTRODUCTION	10
2.1	Range of application	10
2.2	Shade levels	10
2.3	Certification and control labels	11
2.4	Certification markings explanation	11
3	TECHNICAL DATA	13
4	OPERATION	14
4.1	Battery indicator	14
4.2	Charging the battery	14
4.3	Activating the LCD display	14
4.4	Locking/unlocking external control function	14
4.5	Setting shade number	15
4.6	Setting sensitivity	15
4.7	Setting delay	15
4.8	Cutting mode	16
4.9	Saving parameters to memory settings	16
4.10	Optional settings	16
4.11	Using the work light	18
4.12	Removing/installing the ADF flip shell	18
4.13	Adjusting the fit of the helmet	19
5	MAINTENANCE	21
5.1	Replacing the grind lens	21
5.2	Replacing the outer ADF cover lens	21
5.3	Replacing the inner ADF cover lens	21
5.4	Replacing the LED work light cover lens	22
5.5	Replacing the rear t-link, air hose and fire resistant hose cover	22
5.6	Replacing the auto-darkening filter (ADF) and battery case	23
5.7	Cleaning the equipment	24
6	TROUBLESHOOTING	25
	SPARE PARTS	26

1 SAFETY

1.1 Meaning of symbols

As used throughout this manual: Means Attention! Be Alert!



DANGER!

Means immediate hazards which, if not avoided, will result in immediate, serious personal injury or loss of life.



WARNING!

Means potential hazards which could result in personal injury or loss of life.



CAUTION!

Means hazards which could result in minor personal injury.



WARNING!

Before use, read and understand the instruction manual and follow all labels, employer's safety practices and Safety Data Sheets (SDSs).



1.2 Safety instructions for auto-darkening welding helmet and filter

Before use

The auto-darkening welding helmet comes assembled, but before it can be used, perform the following:

- Adjust the helmet to fit the user properly.
- Check battery surfaces and contacts and clean them if necessary.
- Verify that the battery is in good condition and properly installed.
- Set up for delay time, sensitivity, and shade number for your application.

Usage

- The helmet is not suitable for laser welding.
- Never place the helmet and auto-darkening filter on a hot surface.
- The helmet will not protect against severe impact hazards.
- The helmet will not protect against explosive devices or corrosive liquids.
- Should the helmet not darken upon striking an arc, stop welding immediately and contact ESAB.
- Do not immerse the filter in water.
- The materials which may come into contact with the wearer's skin can cause allergic reactions in some circumstances.
- The filter shall only be used in conjunction with the inner cover lens.

Maintenance

- The helmet should be stored in a cool, dry, and dark place. Remove the battery before long-time storage.
- Protect filter from contact with liquid and dirt.
 - Clean the filter surface regularly by using clean water and a lint-free or microfiber cloth; do not use strong cleaning solutions. Always keep the sensors and solar cells clean using a clean lint-free tissue or microfiber cloth.
 - Regularly replace the cracked/scratched/pitted front cover lens. Avoid setting the helmet down directly on the cover lens to avoid premature damage to the cover lens.

- Never open or tamper with the filter. There are no user-serviceable parts inside.
- Do not make any modifications to either the filter or helmet, unless specified in this manual.
- Only use replacement parts that are specified in this manual.
- Unauthorized modifications and replacement parts will void the warranty and expose the operator to personal injury.
- Do not use any solvents on the filter screen or helmet components.

1.3 Safety precautions



WARNING!

These Safety Precautions are for your protection. They summarise precautionary information from the references listed in Additional Safety Information section. Before performing any installation or operating procedures, be sure to read and follow the safety precautions listed below as well as all other manuals, material safety data sheets, labels, etc. Failure to observe Safety Precautions can result in injury or death.



PROTECT YOURSELF AND OTHERS

Some welding, cutting and gouging processes are noisy and require ear protection. The arc, like the sun, emits ultraviolet (UV) and other radiation and can injure skin and eyes. Hot metal can cause burns. Training in the proper use of the processes and equipment is essential to prevent accidents. Therefore:

1. Wear a welding helmet fitted with a proper shade of filter to protect your face and eyes when welding or watching.
2. Always wear safety glasses with side shields in any work area, even if welding helmets face shields and goggles are also required.
3. Use a face shield fitted with the correct filter and cover plates to protect your eyes, face, neck and ears from sparks and rays of the arc when operating or observing operations. Warn bystanders not to watch the arc and not to expose themselves to the rays of the electric-arc or hot metal.
4. Wear flameproof gauntlet type gloves, heavy long-sleeve shirt, cuff less trousers, high-topped shoes and a welding helmet or cap for protection, to protect against arc rays and hot sparks or hot metal. A flameproof apron may also be desirable as protection against radiated heat and sparks.
5. Hot sparks or metal can lodge in rolled up sleeves, trouser cuffs, or pockets. Sleeves and collars should be kept buttoned and open pockets eliminated from the front of clothing.
6. Protect other personnel from arc rays and hot sparks with a suitable non-flammable partition or curtains.
7. Use goggles over safety glasses when chipping slag or grinding. Chipped slag may be hot and can fly far. Bystanders should also wear goggles over safety glasses.



FIRES AND EXPLOSIONS

Heat from flames and arcs can start fires. Hot slag or sparks can also cause fires and explosions. Therefore:

1. Protect yourself and others from flying sparks and hot metal.
2. Remove all combustible materials well away from the work area or cover the materials with a protective non-flammable covering. Combustible materials include wood, cloth, sawdust, liquid and gas fuels, solvents, paints and coatings paper, etc.
3. Hot sparks or hot metal can fall through cracks or crevices in floors or wall openings and cause a hidden smoldering fire or fires on the floor below. Make certain that such openings are protected from hot sparks and metal.
4. Do not weld, cut or perform other hot work until the work piece has been completely cleaned so that there are no substances on the work piece which might produce flammable or toxic vapors. Do not do hot work on closed containers, they may explode.

5. Have fire extinguishing equipment handy for instant use, such as a garden hose, water pail, sand bucket, or portable fire extinguisher. Be sure you are trained in its use.
6. Do not use equipment beyond its ratings. For example, an overloaded welding cable can overheat and create a fire hazard.
7. After completing operations, inspect the work area to make certain there are no hot sparks or hot metal which could cause a later fire. Use fire watchers when necessary.



ELECTRICAL SHOCK

Contact with live electrical parts and ground can cause severe injury or death. DO NOT use AC welding current in damp areas, if movement is confined, or if there is danger of falling. Therefore:

1. Be sure the power source frame (chassis) is connected to the ground system of the input power.
2. Connect the workpiece to a good electrical ground.
3. Connect the work cable to the workpiece. A poor or missing connection can expose you or others to a fatal shock.
4. Use well-maintained equipment. Replace worn or damaged cables.
5. Keep everything dry, including clothing, work area, cables, torch/electrode holder and power source.
6. Make sure that all parts of your body are insulated from both the work piece and from the ground.
7. Do not stand directly on metal or the earth while working in tight quarters or a damp area; stand on dry boards or an insulating platform and wear rubber-soled shoes.
8. Put on dry, hole-free gloves before turning on the power.
9. Turn off the power before removing your gloves.
10. Refer to ANSI/ASC Standard Z49.1 for specific grounding recommendations. Do not mistake the work lead for a ground cable.



ELECTRIC AND MAGNETIC FIELDS

May be dangerous. Electric current flowing through any conductor causes localized Electric and Magnetic Fields (EMF). Welding and cutting current creates EMF around welding cables and welding machines. Therefore:

1. Welders having pacemakers should consult their physician before welding. EMF may interfere with some pacemakers.
2. Exposure to EMF may have other health effects which are unknown.
3. Welders should use the following procedures to minimise exposure to EMF:
 - a) Route the electrode and work cables together. Secure them with tape when possible.
 - b) Never coil the torch or work cable around your body.
 - c) Do not place your body between the torch and work cables. Route cables on the same side of your body.
 - d) Connect the work cable to the workpiece as close as possible to the area being welded.
 - e) Keep welding power source and cables as far away from your body as possible.



FUMES AND GASES

Fumes and gases, can cause discomfort or harm, particularly in confined spaces. Shielding gases can cause asphyxiation. Therefore:

1. Keep your head out of the fumes. Do not breathe the fumes and gases.
2. Always provide adequate ventilation in the work area by natural or mechanical means. Do not weld, cut or gouge on materials such as galvanized steel, stainless steel, copper, zinc, lead beryllium or cadmium unless positive mechanical ventilation is provided. Do not breathe fumes from these materials.
3. Do not operate near degreasing and spraying operations. The heat or arc can react with chlorinated hydrocarbon vapors to form phosgene, a highly toxic gas and other irritant gases.

4. If you develop momentary eye, nose or throat irritation while operating, this is an indication that ventilation is not adequate. Stop work and take necessary steps to improve ventilation in the work area. Do not continue to operate if physical discomfort persists.
5. Refer to ANSI/ASC Standard Z49.1 for specific ventilation recommendations.
6. **WARNING:** This product when used for welding or cutting, produces fumes or gases which contain chemicals known to the State of California to cause birth defects and in some cases cancer (California Health & Safety Code §25249.5 et seq.)



CYLINDER HANDLING

Cylinders, if mishandled, can rupture and violently release gas. A sudden rupture of cylinder valve or relief device can injure or kill. Therefore:

1. Locate cylinders away from heat, sparks and flames. Never strike an arc on a cylinder.
2. Use the proper gas for the process and use the proper pressure reducing regulator designed to operate from the compressed gas cylinder. Do not use adaptors. Maintain hoses and fittings in good condition. Follow manufacturer's operating instructions for mounting regulator to a compressed gas cylinder.
3. Always secure cylinders in an upright position by chain or strap to suitable hand trucks, undercarriages, benches, wall, post or racks. Never secure cylinders to work tables or fixtures where they may become part of an electrical circuit.
4. When not in use, keep cylinder valves closed. Have valve protection cap in place if regulator is not connected. Secure and move cylinders by using suitable hand trucks.



MOVING PARTS

Moving parts, such as fans, rotors and belts can cause injury. Therefore:

1. Keep all doors, panels, guards and covers closed and securely in place.
2. Stop engine or drive systems before installing or connecting unit.
3. Have only qualified people remove covers for maintenance and troubleshooting as necessary.
4. To prevent accidental starting of equipment during service, disconnect negative (-) battery cable from battery.
5. Keep hands, hair, loose clothing and tools away from moving parts.
6. Reinstall panels or covers and close doors when service is finished and before starting engine.



WARNING! **FALLING EQUIPMENT CAN INJURE**

- Only use lifting eye to lift unit. Do NOT use running gear, gas cylinders or any other accessories.
- Use equipment of adequate capacity to lift and support unit.
- If using lift forks to move unit, be sure forks are long enough to extend beyond opposite side of unit.
- Keep cables and cords away from moving vehicles when working from an aerial location.



**WARNING!
EQUIPMENT MAINTENANCE**

Faulty or improperly maintained equipment can cause injury or death. Therefore:

1. Always have qualified personnel perform the installation, troubleshooting and maintenance work. Do not perform any electrical work unless you are qualified to perform such work.
2. Before performing any maintenance work inside a power source, disconnect the power source from the incoming electrical power.
3. Maintain cables, earthing wire, connections, power cord and power supply in safe working order. Do not operate any equipment in faulty condition.
4. Do not abuse any equipment or accessories. Keep equipment away from heat sources such as furnaces, wet conditions such as water puddles, oil or grease, corrosive atmospheres and inclement weather.
5. Keep all safety devices and cabinet covers in position and in good repair.
6. Use equipment only for its intended purpose. Do not modify it in any manner.



**WARNING!
WELDING HELMET CRITERIA**

1. The protection according to Z87.1 is only given if it is ensured that the product is assembled according to the manufacturer's instructions.
2. The eye-protectors against high-speed particles worn over standard ophthalmic spectacles may transmit impacts, thus creating a hazard to the wearer.
3. If the impact letter followed by letter "T", you can use it for protection against high-speed particles at extremes of temperature. If the impact letter does not follow by letter "T", you should only use the eye protector for protection against high-speed particles at room temperature.
4. A visual inspection of the complete protector is necessary before each use.
5. This protector is appropriate for the headform 1-M.
6. Protector can affect the recognition of colours and/or signal light detection.
7. Protectors that have been subject to impact shall not be used and shall be discarded and replaced.
8. If the impact level symbols are not equal on both the lens/filter and the frame, then it is the lower level that shall be assigned to the complete protector.
9. The protections corresponding to the code numbers/letter 7, 9, CH are provided by the complete protector only if the respective symbols are equal on both the lens and the frame.
10. Not suitable for driving and road use.

**CAUTION!
ADDITIONAL SAFETY INFORMATION**

For more information on safe practices for electric arc welding and cutting equipment, ask your supplier for a copy of “Precautions and Safe Practices for Arc Welding, Cutting and Gouging”, Form 52-529.

The following publications are recommended:

- ANSI/ASC Z49.1 - “Safety in Welding and Cutting”
- AWS C5.5 - “Recommended Practices for Gas Tungsten Arc Welding”
- AWS C5.6 - “Recommended Practices for Gas Metal Arc welding”
- AWS SP - “Safe practices” - Reprint, Welding Handbook
- ANSI/AWS F4.1 - “Recommended Safe Practices for Welding and Cutting of Containers That Have Held Hazardous Substances”
- OSHA 29 CFR 1910 - "Safety and health standards"
- CSA W117.2 - "Code for safety in welding and cutting"
- NFPA Standard 51B, “Fire Prevention During Welding, Cutting, and Other Hot Work”
- CGA Standard P-1, “Precautions for Safe Handling of Compressed Gases in Cylinders”
- ANSI Z87.1, "Occupational and Educational Personal Eye and Face Protection Devices"

1.4 California proposition 65 warning

**WARNING!**

Welding or cutting equipment produces fumes or gases which contain chemicals known in the State of California to cause birth defects and, in some cases, cancer. (California Health & Safety Code Section 25249.5 et seq.)

**WARNING!**

This product can expose you to chemicals including lead, which are known to the state of California to cause cancer and birth defects or other reproductive harm. Wash hands after use.

For more information, go to www.P65Warnings.ca.gov.

1.5 Regulatory information

Please take attention that changes or modification not expressly approved by the party responsible for compliance could void the user’s authority to operate the equipment.

This device complies with Part 15 of the FCC Rules. Operation is subject to the following two conditions:

- (1) This device may not cause harmful interference, and
- (2) This device must accept any interference received, including interference that may cause undesired operation.

2 INTRODUCTION

The **Sentinel A70 Air PRO** is a light weight welding helmet intended for use in electric arc welding to protect against UV/IR rays, heat and sparks in any state from clear to dark. The protection shades of the welding helmets have been chosen to avoid eye damage caused by the welding arc. The helmet does not have to be flipped up and down during welding so both hands are kept free.

ESAB has an assortment of welding accessories and personal protection equipment for purchase. For ordering information contact your local ESAB dealer or visit us on our website.

2.1 Range of application

The Sentinel A70 Air PRO welding helmet can be used for the following applications:

- Electrode
- MIG
- Mag
- TIG (>=3A)

The Sentinel A70 Air PRO welding helmets are **not** suitable for use with laser systems and oxyacetylene (gas welding) applications. The welding filter must not be used for any other purpose other than arc welding. The helmet should never be used as sunglasses when driving as this could lead to incorrect identification of the color of traffic light.

The automatic welding filter will operate well under extreme low light conditions and very strong sunlight.

2.2 Shade levels

Sentinel A70 Air PRO welding helmets may be used only in connection with arc welding. The following table shows how to choose the most suitable shade level:

Welding process Orrelated techniques	Current internally in amperes													
	0.5	2.5	10	20	40	80	125	175	225	275	350	450		
	1	5	15	30	60	100	150	200	250	300	400	500		
Manual Flux cpe electrodes Fluxed stick electrodes					9	10	11			12		13		14
MIG / Metal-Inert-Gas Argon (Ar/He) Steels, alloyed steels, Copper & its alloys etc.							10	11	12			13		14
MIG / Metal-Inert-Gas Argon (Ar/He) Aluminium, copper, nickel And other alloys.							10	11	12	13		14	15	
TIG / Tungsten-Inert Gas Argon (Ar/H2) (Ar/He) All weldable metals such as steels, aluminium, Copper, nickel and their alloys.					9	10	11	12	13					
MAG / Metal-active Gas (Ar/Co2O2) (Ar/Co2/He/H2) Construction Steel, hardened & tempered steels Cr-Ni-steel, Cr-steel & other alloyed steels.							10	11	12	13		14	15	
Electric arc compressed air joining (Melt joining) carbon electrodes (O2) Flame grooving compressed air (O2)									10	11	12	13	14	15
Plasma cutting (fusion cutting) All weldable metals see WIG Center and outer gas: Argon (Ar/H2) (Ar/He)							11		12		13			
Plasma cutting (Fusion cutting) Micro-plasma welding Center and outer gas: Argon (Ar/H2) (Ar/He)	2.5	5	6	7	8	9	10	11	12	13		14		15
	4													
	1	5	15	30	60	100	150	200	250	300	400	500		
	0.5	2.5	10	20	40	80	125	175	225	275	350	450		

(1) As a rule of thumb, start with a shade that is too dark, then go to a lighter shade which gives a sufficient view of the weld zone without going below the minimum. In oxyfuel gas welding or cutting where the torch produces a high yellow light, it is desirable to use a filter lens that absorbs the yellow or sodium line the visible light of the (spectrum) operation.

⁽²⁾ These values apply where the actual arc is seen. Experience has shown that lighter filters may be used when the arc is hidden by the workpiece. Data from ANSI Z49.1-2005.

2.3 Certification and control labels



European conformity mark.

This confirms that the product fulfils the requirements of the PPE Regulation 2016/425.

2.4 Certification markings explanation

Welding helmet

EN ISO 16321: 16321 ESAB W15 E 1-M CE

16321 = Number of the standard

ESAB = Manufacturer code

W15 = Maximum shade number of welding filter

E = Impact level (120 m/s)

1-M = Head-form size

CE = European Conformity

Front/inside cover lens

EN ISO 16321: ESAB 1 E CE

ESAB = Manufacturer code

1 = Enhanced optical performance

E = Impact level (120 m/s)

CE = European Conformity

Auto-darkening filter

EN ISO 16321: 16321 ESAB W3/5-13 V1 CE

16321 = Number of the standard

ESAB = Manufacturer code

W = Welding filter

3 = Light state scale number

This helmet was tested and certified by:

ECS GmbH

Huettfeldstrasse 50, Obere Bahnstrasse 74

73430 AALEN, GERMANY

Notified body number 1883

The Sentinel A70 Air PRO helmet, when used in accordance with the manufacturers instructions and EPR-X1.1 Air blower unit (0700500920), conform to the following respiratory standard:

EN12941:1998+ A2:2008 TH3P

This helmet, with the ESAB EPR-X1.1 PAPR was tested and certified by:

Module B Notified Body: Vyzkumny ustav bezpecnosti prace, v. v. i., Jeruzalemska 1283/9,

110 00 Praha 1, Czech Republic

Notified body number 1024

3 TECHNICAL DATA



Dimensions l×w×h	298 × 286 × 332 mm
Weight	1200 g
Optical class	ISO V1
Viewing area	123 × 76 mm (4.65" × 2.8")
Arc sensors	4
Light state	DIN 3
Grind state	DIN 3
Welding mode	Shade no. from 5-13
Shade control	Internal and external digital control
Power On/Off	Automatic On/Off
Sensitivity control	10-step, digital control (internal and external)
UV/IR protection	Up to shade DIN 16 at all times
Power supply	Solar cell. Rechargeable Li-Ion battery
Switching time	1/25,000 s. from light to dark
Grinding	Yes – through flip-up ADF design
Cutting	Selectable from shade 5-13
Delay (dark to light)	10-step, digital control (internal and external) from 0.1 ~ 0.9 s
Low amperage TIG rated	≥ 3 amps
Operating temperature	-10°C to 65°C (14°F to 149°F)
Storing temperature	-20°C to 85°C (-4°F to 185°F)
Approved certifications	CE, ANSI Z87.1, CSA Z94.3, AS/NZS 1338.1 CE EN 12941 (with EPR-X1.1 PAPR)

4 OPERATION

4.1 Battery indicator

This Auto-Darkening Filter (ADF) is powered by a rechargeable battery.

The  symbol shows the current state of the battery.

Charge the battery when the indicator symbol shows  and the  red LED is continuously illuminated.

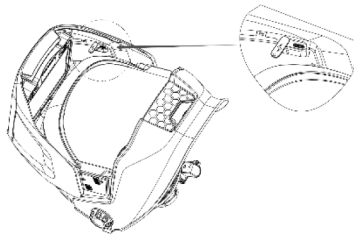

4.2 Charging the battery

**WARNING!**

Fully charge the battery before initial use! Charge the battery when “Low battery” LED is illuminated.

- 1) Locate the USB-C charge port.
- 2) Open the protective cover on charge port.
- 3) Charge by using the included USB-C type cable connected to a power source of 5V/2A.

The ADF screen shows the charge status.

4.3 Activating the LCD display

- 1) Press any button on the ADF’s control panel or press the external button to activate the LCD display.

The LCD display automatically turns off after 3 seconds if there is no operation. Symbols on the LCD display are illuminated with a yellow block during adjustment.

4.4 Locking/unlocking external control function

**WARNING!**

Unlock the external control function when using the external control!

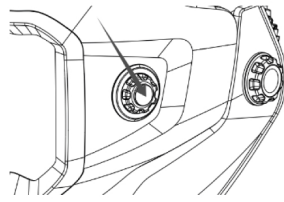

- 1) Press the external button, as shown in the following illustration, to unlock the external control function.



The external control function locks when the LCD display is blank or inactive.



4.5 Setting shade number

Shade selection can only be adjusted while using the welding mode.

- 1) Select “Welding mode” by pressing the external button for more than 2 seconds, or press the “Mode” button on the internal ADF control panel.
- 2) Select the shade number by pressing the external button on shell, or press the “Set” button on the internal ADF control panel. The shade number is illuminated by a yellow block when the setting is ready for adjustment.
- 3) Rotate the external control dial to adjust shade from shade 5-13; or press  to increase the shade number or  to reduce the shade setting on the internal ADF control panel.
- 4) Select the proper shade number for your welding or cutting process according to the shade level table in this manual.

4.6 Setting sensitivity

Sensitivity can be adjusted only while using the welding mode.

- 1) Select “Welding mode” by pressing the external button for more than 2 seconds, or press the “Mode” button on the internal ADF control panel.
- 2) Select the sensitivity setting by pressing the external button until the “Sens” setting is illuminated by a yellow box, or press the “Set” button on the internal ADF control panel.
- 3) Rotate external control to adjust sensitivity level from level 1-10, or press  to increase the sensitivity level, and  to reduce the sensitivity level on internal ADF control panel.

The sensitivity setting allows the ADF to become more or less sensitive to arc light, for different welding processes.

- Low sensitivity is suitable for outdoor use where excessive ambient/environmental light conditions exist, and/or with higher amperage SMAW and FCAW operations.
- High sensitivity is suitable for low amperage welding typically used with GTAW or GMAW operations.
- Under normal welding conditions, a higher sensitivity setting is recommended.

4.7 Setting delay

Delay can be adjusted only while using the welding mode.

- 1) Select "Welding mode" by pressing the external button for more than 2 seconds, or press the "Mode" button on the internal ADF control panel.
- 2) Select the delay setting by pressing the external button until the "Delay" setting is illuminated by a yellow box, or press the "Set" button on the internal ADF control panel.
- 3) Rotate external control to adjust delay level from level 1-10, or press Δ to increase the delay level, and ∇ to reduce the delay level on internal ADF control panel .

The delay setting adjusts the amount of time the ADF takes to lighten back to shade 3 after welding.

- The longest time is about 0.9 seconds depending upon welding point temperature and the shade setting. This setting is ideal for welding at high amperage where there is an afterglow from the welding operation.
- The shortest time is about 0.1 second depending upon welding point temperature and shade setting. This setting is ideal for tack welding or production welding with short weld durations.

4.8 Cutting mode

- 1) Select "Cutting mode" by pressing the external button for more than 2 seconds, or press the "Mode" button on the internal ADF control panel.
"Cutting" shows in the internal display to indicate the selected mode, and a green LED light flashes continuously.
- 2) Rotate external control to adjust shade number from 5-13, or select the shade number from 5-13 by pressing Δ and ∇ on the ADF's internal control panel.
- 3) Press the external button for more than 2 seconds on shell, or press the "Mode" button on the internal ADF control panel to revert the ADF back to "welding mode".

4.9 Saving parameters to memory settings



It's possible to save the setting parameters into a memory setting. Users can recall a memory at any time they need. The system can save up to 20 sets of parameters. Take memory setting 1 as an example:

- 1) Set shade, sensitivity, and delay according to previously steps.
- 2) Press the \ominus button on the ADF control panel for more than 2 seconds, and select memory set to position "1" by pressing Δ or ∇ .
- 3) Press the "set" button or press the external button.
The memory position will be position "1".
- 4) MEMORY 2 to MEMORY 20 can be set the same way.

Users can call out the MEMORY setting by selecting the memory position via short press "MEMORY" first and then choosing the desired memory number via Δ and ∇ . The ADF will change to the selected setting from memory automatically after 10 seconds.

4.10 Optional settings

- 1) Press the "set" button on ADF's internal control panel for more than 2 seconds to open the optional settings menu.

2) Press the  and  buttons to select various parameter settings.

a) Screen saver



Choose ON/OFF by pressing the  and  buttons and then press “set” confirm and exit.

When “ON” is chosen, the LCD display will show a 24-hour clock .



b) ARC –welding acr recording

ARC is used to record the amount of time the ADF has spent in any darkened or active state.

To choose a different function, press the  and  buttons, and exit by pressing the “set” button after choosing the “Exit” icon



Duration = Total ADF activation time during one 24-hour period. This setting will cycle back to “0” after the measured time reaches “23:59”. Pressing “set” will clear all of the data for that shown time period and bring the time back to “0:01”.

Display = Total welding time record. This will show at the left corner of LCD display when “ON” is selected.

Recent = Total ARC activation time over the course of 7 days. Press “Set” to review the data .





c) Bluetooth

Bluetooth is available to connect the helmet operations to a mobile device. The helmet may be used with the ESAB mobile app to to change settings on the helmet, view data and find helpful online tools. Toggle the BT function ON/OFF by pressing the  and  buttons to select and then press “set” confirm and exit. The LCD display will include a Bluetooth icon when the function is set to “on”.



d) Clock

Set the current date and time by pressing the  and  buttons to to increase and reduce the selected value. Setting values follow Year -> Month -> Day -> Hour -> Minutes-> Save and Exit/ Exit in sequence by pressing the “set” button.



e) Battery

The battery function will show the actual real time battery voltage. Exit by pressing the “set” button.

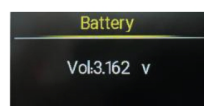

f) Information

The information function will display the associated certificates to which the helmet is tested.

Exit by pressing the “set” button.



4.11 Using the work light

The LED work light, located at the bottom of the main helmet shell, is powered by its own “AA” battery, which is located on the back of the headgear.

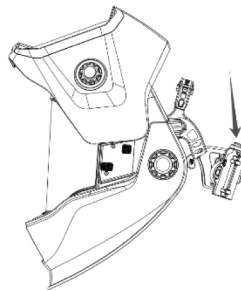

- 1) Press the button located on top of the battery case to turn the work light on or off.

When an arc or strong ambient light is detected, the work light will automatically turn off, and turn on again when the arc is complete or the ambient conditions darken. This allows premium battery life.

- 2) To install and replace the “AA” battery, lift the cover of the battery compartment to access the battery.

4.12 Removing/installing the ADF flip shell

The Sentinel A70 Air PRO helmet can be used as a grinding helmet by flipping up the outer ADF shell or by removing the outer ADF shell completely. Removing the shell allows for a better configuration during longer grinding or other finishing operations.



WARNING!

Only weld when the ADF shell is attached and in the lowered position!

Removing the outer ADF shell

- 1) Raise the outer ADF shell.
- 2) Press both of the upper buttons found on the outer side of the main shell.

- 3) While pressing both buttons, slide the outer ADF shell forward to remove.

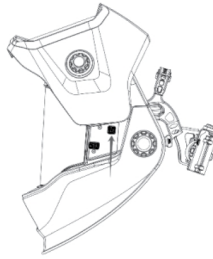

Installing the outer ADF shell

- 1) Reverse the removal process by sliding the ADF shell into the guide slots. The outer ADF shell must be in the “raised” position.
- 2) The outer ADF shell will click into place on both sides of the main shell when it is seated correctly.
- 3) **Ensure that the outer ADF shell is correctly and firmly attached prior to any welding or cutting operation.**

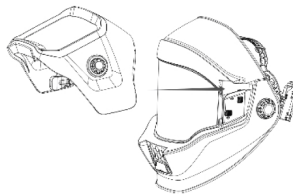

4.13 Adjusting the fit of the helmet

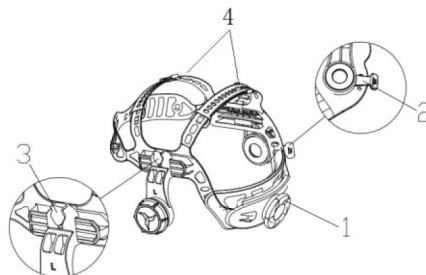

Donning the welding helmet

- 1) By using the tab (attached to the face seal), pull face seal under the chin, fit the helmet on the head, and tighten the ratchet by rotating the wheel at the back of the headgear clockwise.
- 2) Ensure that the head cover is pulled down as far as possible at the back of the head.
- 3) If necessary, enlist the help of another person to ensure best-fit and minimal gaps.



NOTE!

As with all air-equipped PAPR helmets, the user must ensure that the face seal elastic is in contact with the user's face and is in front of the user's ears and NOT covering them. This provides a proper air pressure of filtered air inside of the helmet.

Adjusting the circumference of the headband

- 1) Rotate the knob (1) on the back of the headband to make the overall circumference of the headband larger or smaller.

This can be done while wearing the helmet and allows easy micro-level tension adjustment to keep the helmet firmly on the head without it being too tight.

- 2) If the headband is riding too high or too low on your head, adjust the straps (4) which passes over the top of your head.
 - a) Release the end of the band by pushing the locking pin out of the band's hole.
 - b) Slide the two portions of the band to a greater or lesser width as required.
 - c) Push the locking pin through the nearest hole.

Adjusting the distance between the ADF and face

- 1) Press and hold the slider locking mechanism (3) on both sides, and slide the headgear back and forth within the helmet.
- 2) Ensure the slider is locked back into position and make certain the distance between the lens to both eyes is equal. This avoids issues with uneven ADF darkness.

Adjusting view angle position

- 1) The tilt adjustment is located on the right side of the helmet. Loosen the right headgear tension knob (2) and adjust the lever forward or back to the desired position.
- 2) Retighten the right headgear tension knob.

5 MAINTENANCE

5.1 Replacing the grind lens

Replace the grind lens if it becomes scratched or damaged.

- 1) Press the lower-positioned buttons on both side of shell and remove the grind lens by pulling forward.

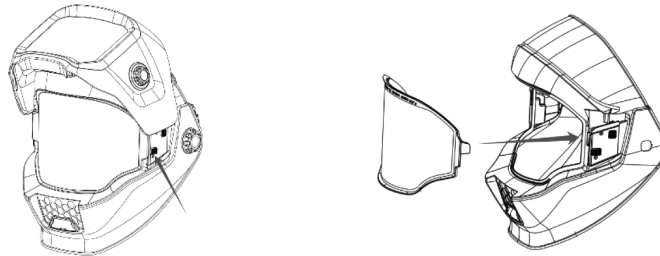

- 2) To install the grind lens, simple insert both sides into the slots. The grind lens locks automatically when installed properly and sounds a click.

5.2 Replacing the outer ADF cover lens

Replace the outer ADF cover lens if it becomes scratched or damaged.

- 1) Pull the front cover retainer bracket from both sides to remove the retainer.
- 2) Remove the cover lens by grasping the lens from the top and pulling forward.



- 3) Place a new lens in the shell by gently bending the lens and setting the left and right edges into the slots located on the ADF shell.
- 4) Reinstall the front cover retainer bracket.

5.3 Replacing the inner ADF cover lens

Replace the inner ADF cover lens if it becomes scratched or damaged.

- 1) Remove the outer ADF shell as noted in the instruction "Removing and installing the ADF flip shell" .
- 2) Lift the inner ADF cover lens at the recess found at the top of the ADF. The inside cover lens will flex upward and release from the cartridge.
- 3) To install a new inner cover lens, gently bend the lens and place the left and right edges into the retaining bracket.

5.4 Replacing the LED work light cover lens

Replace the LED light cover lens if it is damaged.

- 1) Remove the cover lens by pulling the lens out by using the cutout on the lens found at the bottom center.



- 2) Reinstall a new cover lens by inserting both edges into the bracket.

5.5 Replacing the rear t-link, air hose and fire resistant hose cover

- 1) Remove the screws on both sides of the hose.

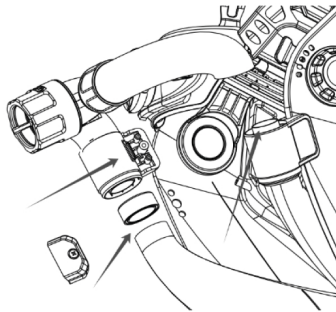

- 2) Remove hose cover and release the hose from the T-link.

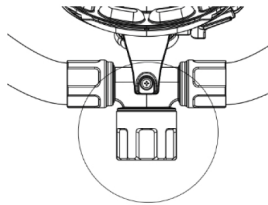

- 3) Remove the screw on headgear hose standoff.
- 4) Replace with a new T-link short hose.
- 5) Perform the reverse operation to install the T-link short hose.

- 6) To replace the fire resistant hose cover, simply pull apart the hook and loop seam and tabs to remove the cover. Replace with a new cover following the reverse procedure, as found in the figures below.

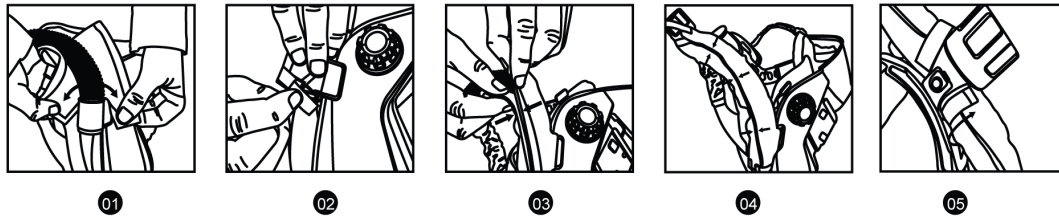

5.6 Replacing the auto-darkening filter (ADF) and battery case

- 1) Remove outer cover and outer cover lens as described in “Replacing the outer ADF cover lens”.
- 2) Disconnect the battery cable from the ADF.

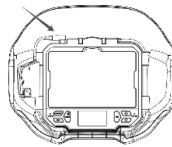

- 3) Press two retaining clips and remove the ADF from the front of the helmet.

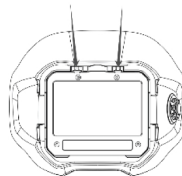

- 4) Install a new ADF, by reversing the removal procedure, making sure the ADF is locked in place by the two retaining clips.
- 5) Install outer cover lens and cover.
- 6) To replace the rechargeable battery and external digital dial, remove the three retaining screws using a Phillips screwdriver.

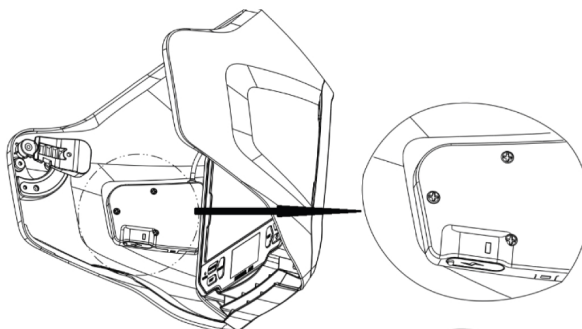

- 7) Install the new rechargeable battery and digital dial by using the retaining screws, and ensure the ADF is plugged into the battery.

5.7 Cleaning the equipment



NOTE!

Do not use strong cleaning solutions.

- 1) Clean helmet by wiping with a soft, dry cloth.
- 2) Clean the cartridge surfaces regularly.

6 TROUBLESHOOTING

Type of fault	Possible cause	Corrective action
Irregular darkening or dimming	Wrong position of the headgear	Make sure the fore/aft adjustment to the headgear is set to the same position on both sides of the headgear. This ensures the correct and equal distance of the Auto-Darkeing Filter (ADF) to the user's eyes.
The ADF does not darken or flicker	The front cover lens is soiled or damaged	Change the cover lens.
	Sensors are soiled	Clean the surface of the sensor.
	Welding current is too low	Increase the sensitivity level.
	Problem with battery	Check the battery and verify it is in good condition. Refer to "Charging the battery".
Slow response	The operating temperature is too low	Do not use at temperatures below -5 °C or 23 °F.
Poor vision	Front / inside cover lens and/or the filter is soiled	Change lens.
	Insufficient ambient light	Increase ambient light.
	Shade number is incorrectly set	Reset the shade number.
	The protective film is still on the outer cover lens	Ensure the protective film has been removed from the outer cover lens before first use.
Welding helmet does not feel secure	Headgear is not properly adjusted	Readjust the headgear.
	Headgear is damaged	Replace the headgear.

APPENDIX

SPARE PARTS

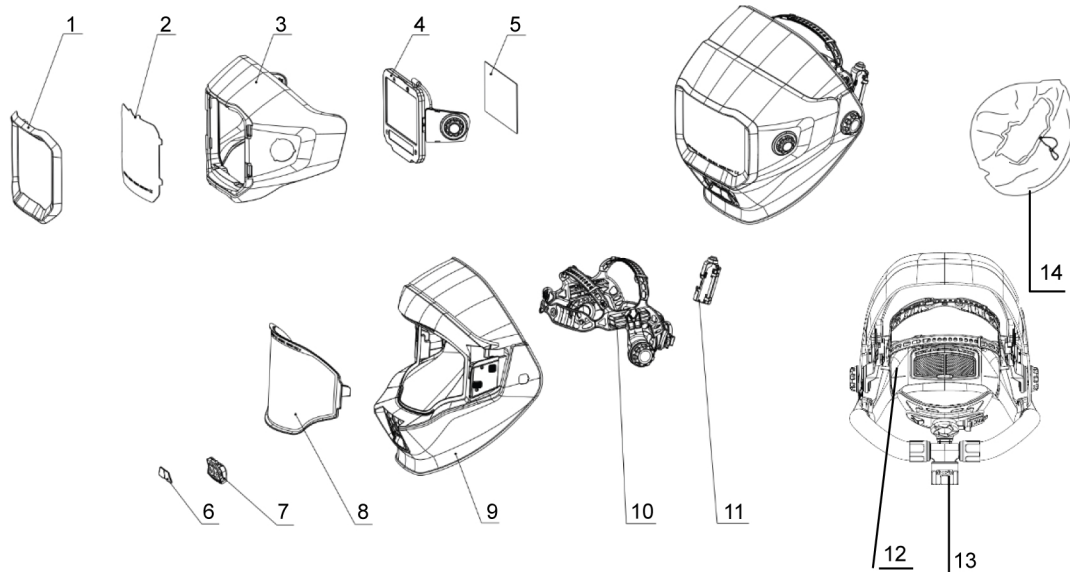

Item	Wear and spare part	Part number
1	A70 Air PRO front cover lens retainer	0700900702
2	A70 Air PRO front cover lens	0700900703
3	A70 Air PRO flip shell	0700900704
4	A70 Air PRO ADF	0700900705
5	A70 Air PRO inner cover lens	0700900707
6	A70 Air PRO LED light cover lens	0700900708
7	A70 Air PRO LED light kit	0700900709
8	A70 Air PRO large grind lens	0700900710
9	A70 Air PRO main shell	0700900712
10	A70 Air PRO headgear	0700900721
	Sentinel headgear occipital pad	0700600884
	Sentinel headgear sweatband	0700600869
11	A70 Air PRO LED light battery housing	0700900914
12	A70 Air PRO duct mesh filter	0700600876
13	A70 Air PRO duct t-link with hose	0700900715
14	A70 Air PRO face seal	0700900720
	A70 Air PRO short hose fire resistant covers	0700900723



A WORLD OF PRODUCTS AND SOLUTIONS.



ESAB AB
Lindholmsallén 9
Box 8004
402 77 Gothenburg
Sweden
Phone +46 (0) 31 50 90 00

ESAB Corporation
2800 Airport Road
Denton, TX 76207
USA
Phone +1 800 378 8123

ESAB Holdings Ltd
322 High Holborn
WC1V 7PB
London, Great Britain
Phone +44 (0) 1992 768515

For contact information visit esab.com

manuals.esab.com

